

## Installation Guide Model TZ45A

### Z-Wave Thermostat

This thermostat is compatible with most HVAC systems, including the following:

- 24VAC systems Note: requires both the 24R and 24C (common) wires
- Standard gas/oil/electric heating systems
  - 1 stage heating and cooling
  - 2 stage heating and cooling
- Heat Pump systems:
  - 1 stage heating and cooling
  - 2 stage heating and cooling
  - 2<sup>nd</sup> or 3<sup>rd</sup> stage Auxiliary heating (heat strips)
- Do NOT use for line voltage controls (120/240VAC)

**Stop!** Before removing your existing thermostat, be sure to label the wires with the terminal markings on the old thermostat and record them below.

#### Standard HVAC System Wiring

Terminal Marking	Meaning	Typical Wire Color	Record the old thermostat wire connections and terminal marking here
C	24VAC Common	Blue	
R	24VAC Return	Red	
G	Fan	Green	
W or W1	Heat stage 1	White	
Y or Y1	Cool stage 1	Yellow	
W2	Heat stage 2	Orange	
Y2	Cool stage 2	Black	

#### Heat Pump HVAC System Wiring

Terminal Marking	Meaning	Typical Wire Color	Record the old thermostat wire connections and terminal marking here
C	24VAC Common	Blue	
R	24VAC Return	Red	
G	Fan	Green	
W or W1	Aux Heat	White	
Y or Y1	Compressor stage 1	Yellow	
O (or B*)	Change Over Valve	Orange (brown*)	
Y2	Compressor stage 2	Black	

\* if you have a terminal marked "B" with a brown wire attached to it, that means you have a changeover (C/O) with heating type heat pump system. Be sure to set the change over type in the **Installer Settings** menu to **C/O Type: w/Heat**. Otherwise leave it set to **w/Cool**.

# INSTALLATION

## HVAC System Setup

The thermostat requires that you setup the type and configuration of your HVAC system for proper operation. This is done in the *Thermostat Info* screen **Setup** button or the *Installer Settings* screen on the thermostat. The *Installer Settings* is a hidden screen. To access it, press the main menu button and when the main menu screen appears, press and hold the middle two buttons for 5 seconds.

### Thermostat Main Menu

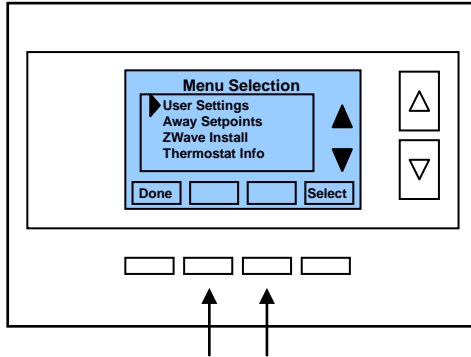

Press and hold two middle buttons to enter the Installer Settings screen

### Installer Settings screen

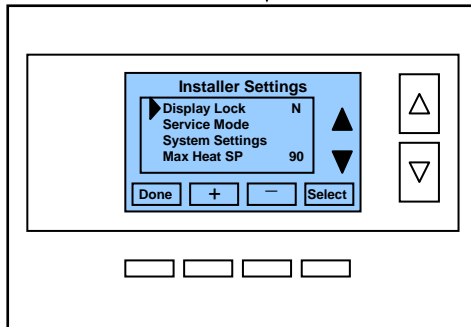

### Installer Settings

Before operating the system, you must configure the thermostat for the correct HVAC system type. You will need to know the following information to correctly configure the thermostat. The HVAC setup is in the *Mechanical Settings* menu screen.

**HVAC system type:** What type HVAC system do you have? Standard or Heat pump

**For Standard systems:** Fan Type: Do you have Gas heat or Electric heat?

**For Heat Pump systems:** Change over valve (or reversing valve) type: Does your system change over with cooling operation or with heating operation? Check your existing

thermostat connects to help determine this. If the original system had an orange wire connected to an "O" terminal, then you have a "changeover with cool" system. If you have a brown wire connected to the "B" terminal, then you have a "change over with heat" system.

## Installer Settings Menu items

### Display Lock

Range: Y or N

Default: N

Y = Display LOCKED

N = Display unlocked

Allows you to lock or unlock the thermostat buttons. When the buttons are locked, you can still access the main menu, but you will not be allowed to select any menu options. The Installer Settings hidden button operation is always operational, allowing you to return to this screen and turn Display Lock off.

### Service Mode

#### **Test Mode**

Range: Y or N

Default: N

Y= Test mode on. Reduces all delays to 10 sec for quicker system testing

N= Test mode off. Normal system delays

**CAUTION: in test mode all system safety delays are shorten. Do not operate the system compressor in test mode. Disconnect Y1 or Y2 outputs if using test mode on a live system.**

### System Settings

Submenu: Sets the HVAC operational settings below

### Mechanical Settings

Submenu: Sets HVAC system type and configuration

#### **Type**

Range: Gas/Elec or Heat pump

Default: Gas/Elec

Selects HVAC type, Gas/Electric or Heat pump

#### **Fan Type**

Range: Gas or Elec

Default: Gas

Selects the Fan type if system is Gas or Electric

#### **C/O Type**

Range: w/Cool or w/Heat

Default: w/Cool

Selects the Heat Pump Changeover Valve type

#### **2<sup>nd</sup> Stage Heat**

Range: Y or N

Default: N

Enables the 2<sup>nd</sup> Stage Heat operation

#### **Aux Heat (HP)**

Range: Y or N

Default: Y

Enables the Auxiliary Heat operation. Typically the Aux Heat will be heat-strips in a Heat Pump system

#### **2<sup>nd</sup> Stage Cool**

Range: Y or N

Default: N

Enables the 2<sup>nd</sup> Stage Cool operation

### Delta Settings

The Delta T Setting is the delta, or difference between, the setpoint and current temp for determining when a heat or cool call comes on. The "delta" is the number of degrees away from setpoint.

#### **H/C Delta**

Range: 3 - 15 degrees.

Default: 3F (1C)

Sets the minimum separation between heating and cooling setpoints. Attempts to lower the cooling below the heating setpoint by this amount will PUSH the heating setpoint down to maintain this separation. Same for setting the heating setpoint above the cooling setpoint, it will PUSH the cooling setpoint up to maintain this separation.

- Heating Delta Stage 1 ON** Range: 1 to 8 degrees Default: 1  
Sets the delta from setpoint that stage 1 heating starts.
- Heating Delta Stage 1 OFF** Range: 0 to 8 degrees Default: 0  
Sets the delta from setpoint that stage 1 heating stops. Stage 1 turns off at setpoint + Delta Stage 1.
- Heating Delta Stage 2 ON** Range: 1 to 8 degrees Default: 2  
Sets the delta from setpoint that stage 2 heating starts.
- Heating Delta Stage 2 OFF** Range: 0 to 8 degrees Default: 0  
Sets the delta from setpoint that stage 2 heating stops. Stage 2 turns off at setpoint + Delta Stage 2.
- Heating Delta Stage 3 ON** Range: 1 to 8 degrees Default: 3  
Sets the delta from setpoint that stage 3 heating starts.
- Heating Delta Stage 3 OFF** Range: 0 to 8 degrees Default: 0  
Sets the delta from setpoint that stage 3 heating stops. Stage 3 turns off at setpoint + Delta Stage 3.
- Cooling Delta Stage 1 ON** Range: 1 to 8 degrees Default: 1  
Sets the delta from setpoint that stage 1 cooling starts.
- Cooling Delta Stage 1 OFF** Range: 0 to 8 degrees Default: 0  
Sets the delta from setpoint that stage 1 Cooling stops. Stage 1 turns off at setpoint - Delta Stage 1
- Cooling Delta Stage 2 ON** Range: 1 to 8 degrees Default: 2  
Sets the delta from setpoint that stage 2 cooling starts.
- Cooling Delta Stage 2 OFF** Range: 0 to 8 degrees Default: 0  
Sets the delta from setpoint that stage 2 Cooling stops. Stage 2 turns off at setpoint -Delta Stage 2.
- Max Heat SP** Range: 40F to 109F (4C-43C) Default: 90F (32C)  
Sets the maximum heating setpoint value. Will not ramp or accept setpoints higher than this maximum.
- Min Cool SP** Range: 44F to 113F (6C-45C) Default: 60F (15C)  
Sets the minimum cooling setpoint value. Will not ramp or accept setpoints lower than this minimum.
- Minimum Run Time (MRT)** Range: 1- 9 Minutes Default: 3  
Sets the minimum run time before a heating/cooling cycle can turn off.  
Sets heating/cooling cycle time. Prevents rapid cycling.
- Minimum Off Time (MOT)** Range: 5-9 Minutes Default: 5  
Sets the minimum off time before another heating/cooling cycle can begin. Provides compressor short cycle protection.
- Temp Response** Range: 1-6 Default: 2  
Adjust the temperature sensor sensitivity. Sets how fast the sensor responds to change.

**Fan Cyclers**  
The fan cyclers function cycles the HVAC system fan for an ON period followed by an Off period continuously. Used to provide minimum air ventilation requirements. When the Fan

ON time is set to a value greater than 0, an additional “Cycler” FAN mode is present when pressing the FAN button.

**Fan ON Time**            Range: 0-120 minutes            Default: 0 (=OFF)  
**Fan OFF Time**        Range: 10-120 minutes        Default: 10

**Restore Defaults**            Range: Yes, No            Default: No  
 Restores all settings to factory defaults.  
 Press Yes to restore defaults,  
 Press No to exit and not restore defaults

**Relay Status**            Display the status (on/off) of the thermostat output relays

**Installer Settings Summary**

Setting	Range	Default	
Display Lock	Y or N	N	Locks out front buttons
Service Mode Submenu			
Test Mode	Y or N	N	Reduces delays for testing
System Settings Submenu			
Mechanical Settings Submenu			
Sys Type	Std or HP	Std	
Fan Type	Gas or Elec	Gas	
C/O Type	w/Heat or w/Cool	w/Cool	
2 <sup>nd</sup> Stage Heat	Y or N	N	
Aux Heat	Y or N	Y	
2 <sup>nd</sup> Stage Cool	Y or N	N	
H/C Delta	3 – 15 deg	3	
Heat Delta Stage 1 On	1 – 8	1	
Heat Delta Stage 1 Off	0 – 8	0	
Heat Delta Stage 2 On	1 – 8	2	
Heat Delta Stage 2 Off	0 – 8	0	
Heat Delta Stage 3 On	1 – 8	3	
Heat Delta Stage 3 Off	0 – 8	0	
Cool Delta Stage 1 On	1 – 8	1	
Cool Delta Stage 1 Off	0 – 8	0	
Cool Delta Stage 2 On	1 – 8	2	
Cool Delta Stage 2 Off	0 – 8	0	
Max Heat SP	40-109F (4-42C)	90F	
Min Cool SP	44-113F (6-45C)	60F	
Min Run Time	1-9 min	3	
Min Off Time	1-9 min	5	
Temp Response	1-6	2	
Fan Cycler Submenu			
Fan Cycler ON time	0 – 120 min	0	0 = Fan Cycler OFF
Fan Cycler Off Time	10 – 120 min	10	
Restore Defaults	Yes or No	No	No on exit
<b>USER SETTINGS</b>			
Filter Service Submenu			
Service Interval	Disabled, 100-4000 hrs	300	
Maint Service Submenu			
Maint Interval	Disabled, 100-4000 hrs	3000	
Screen Timeout (to minimized screen)	0, 20-120 sec	0	0 = off
F/C Mode	F or C	F	
Sensor Calibration Submenu	Internal -7 to +7	0	
Backlite/Display Submenu			
Backlite Timeout	0, 20-120	0	0 = backlite off
Contrast	0-20	14	

# Standard Gas/Electric HVAC System Wiring

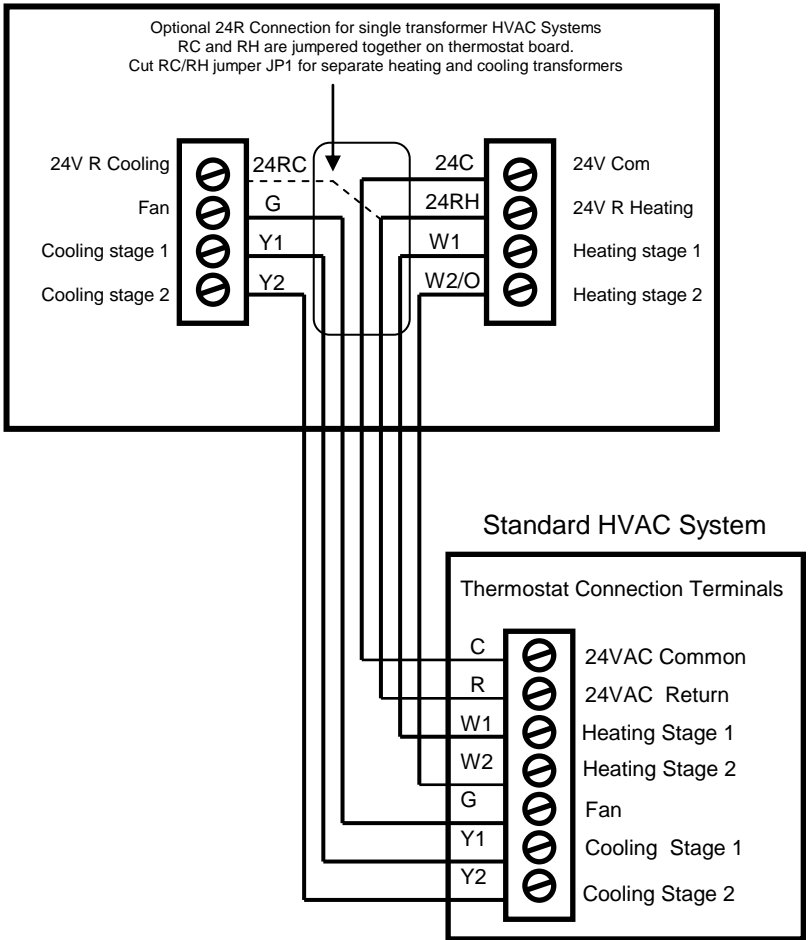

## Thermostat Setup: Standard Gas/Electric HVAC Systems

To set the HVAC system type, go to the *Thermostat Info* screen **Setup** or the *Installer Settings* menu (a hidden screen – go to the main menu screen and press and hold the center two buttons for 5 seconds)

In the *Installer Settings* Menu, Select *System Settings* then select *Mechanical Settings* and set the following:

- Type.** Set the HVAC System Type: set to **Gas/Elec**
- Fan Type.** Set the HVAC Fan Type:  
Set to **Gas** for typical gas furnace (fan is controlled by the furnace)  
Set to **Elec** for electric heat (fan call with heat call)
- C/O type.** Not used for standard systems. Ignore this setting.
- 2nd Stage Heat.** Enable second stage heating outputs  
If you have a single stage heating system, leave this set to **N**  
If you have a 2 stage heating system, set to **Y** to enable.
- Aux Heat (HP).** Not used for standard systems. Ignore this setting
- 2nd Stage Cool.** Enable second stage cooling outputs  
If you have a single stage cooling system, leave this set to **N**.  
If you have a two stage cooling system, set to **Y** to enable.

- Default Setup:
- Standard System
  - Gas Heat
  - 1 Stage heating
  - 1 Stage cooling

No setup required for this configuration

# Heat Pump HVAC System Wiring

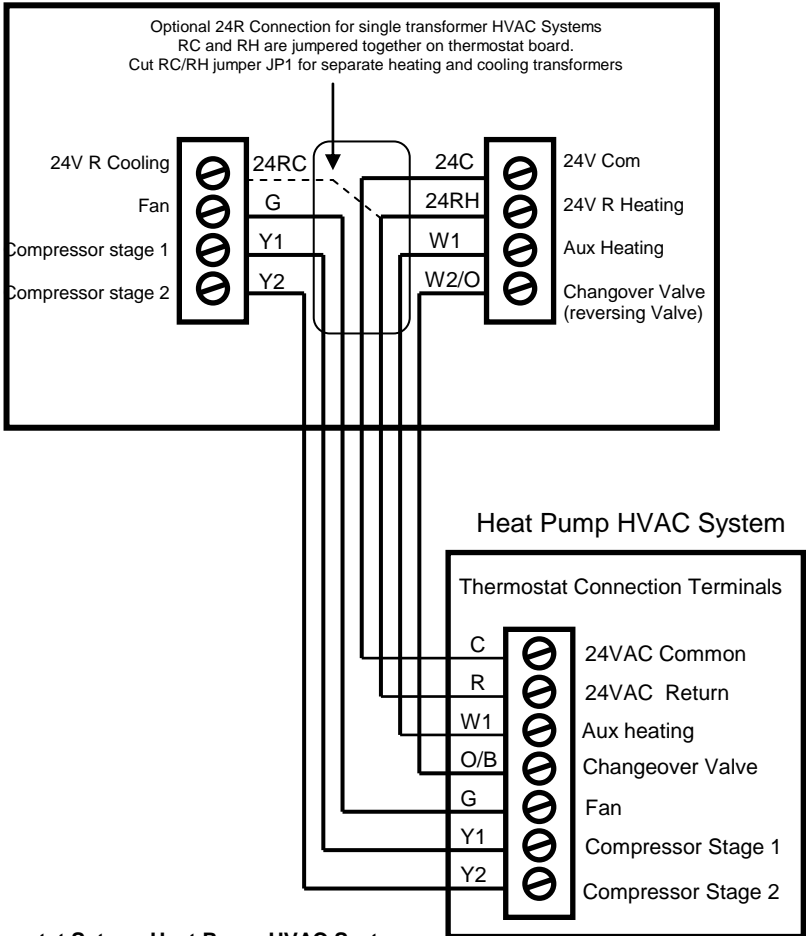

## Thermostat Setup: Heat Pump HVAC Systems

To set the HVAC system type, go to the *Thermostat Info* screen **Setup** or the *Installer Settings* menu (a hidden screen – go to the main menu screen and press and hold the center two buttons for 5 seconds)

In the Installer Settings Menu, Select *System Settings* then select *Mechanical Settings* and set the following:

- Type.** Set the HVAC System Type: set to **Heat pump**
- Fan Type.** Automatically set for Heat Pump systems. Ignore this setting
- C/O type.** Change Over valve energizes either with cool calls or with heat calls. You must configure the thermostat's changeover valve setting to work correctly with your HVAC system. Check your system information to be sure. Note the color of the wire (Orange or Brown) and to which terminal (O or B) **on the old thermostat** the wire was connected to. No matter what the old stat connection was, connect the wire to the W2/O terminal on the TZ45. The setting for C/O type will set the correct system operation.
  - For change over with cool systems (old stat O terminal/orange wire) = set to **w/cool** (most common type and default setting)
  - For change over with heat systems (old stat B terminal/brown wire) = set to **w/heat**
  - Note: If you get cooling when you expect heating, change the C/O type to the opposite setting
- 2nd Stage Heat.** Enable second stage heating outputs  
 If you have a single stage heating system, leave this set to **N**  
 If you have a 2 stage heating system, set to **Y** to enable.
- Aux Heat (HP).** If you have auxiliary heat strips, set this to **Y** (default setting), if not, set to **N**
- 2nd Stage Cool.** Enable second stage cooling outputs  
 If you have a single stage cooling system, leave this set to **N**.  
 If you have a two stage cooling system, set to **Y** to enable.

# Operation Guide Model TZ45A

## Z-Wave Thermostat

### Main Thermostat Screen

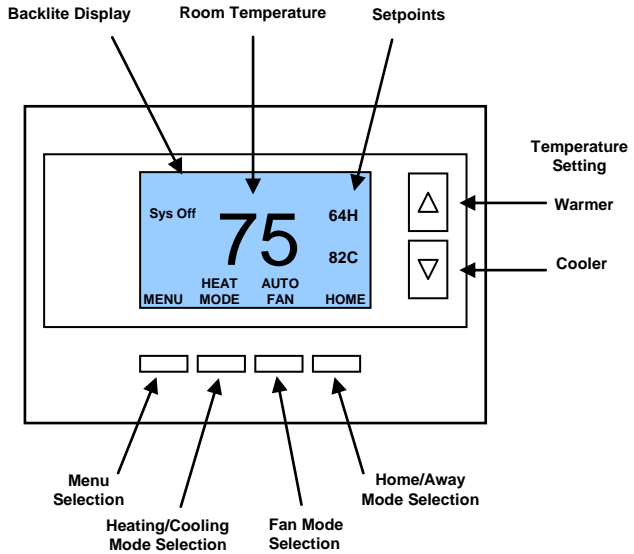

### Minimized Display

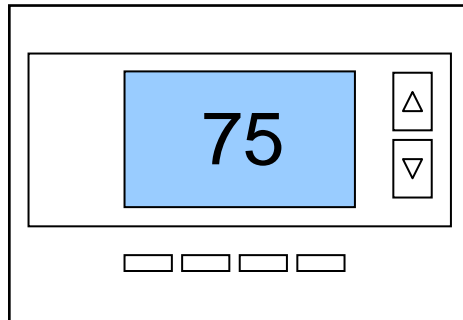

Press any button to return to the main thermostat screen



# Setting the heating or cooling temperature setpoint

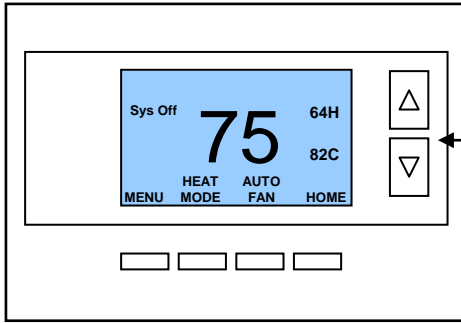

Press a button to go to the setpoint change screen

Setpoint change screen

Press the up or down arrow buttons to set the desired temperature setpoint

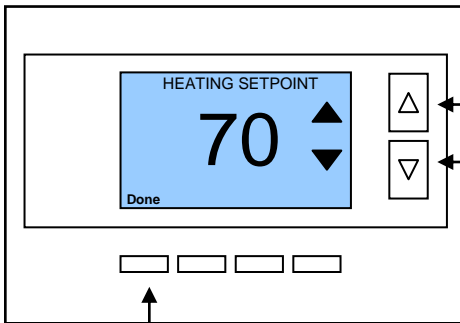

Raise Temperature

Lower Temperature

Pressing the up or down buttons will increment the setpoint 1 degree. Press and hold the button to ramp the setpoint.

Press "DONE" button to set the setpoint and exit back to the main thermostat screen or wait for the screen to automatically time out.

**!** *If the System Mode is OFF, pressing either the Up or Down buttons will take you to the System Mode screen. You must first set an operating mode before you can set or change the setpoint.*

**!** *To change the Heat Setpoint you must be in the Heating mode, to change the Cool Setpoint you must be in the Cooling mode. If you are in Auto mode, the mode of the last system call will be the setpoint screen displayed.*

**Setpoint Push:** Note that you cannot lower the cooling setpoint below the heating setpoint. The thermostat will "push" the heating setpoint lower if you try to lower the cooling setpoint below the heating setpoint. It maintains a 3 degree separation between the heating and cooling setpoint. The same is true for raising the heating setpoint above the cooling setpoint. Again the thermostat will "push" the cooling setpoint up to maintain the 3 degree separation.

# Setting the System Mode: Off, Heat, Cool, Auto

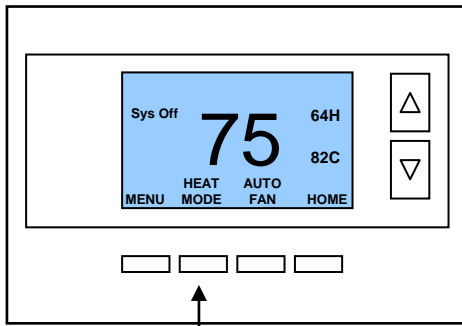

Press Mode button to change system mode

System Mode change screen

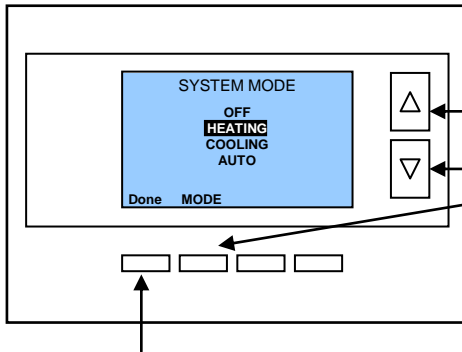

Press the UP or DOWN buttons or MODE button to select the desired system mode.

Press "DONE" button to select the mode and exit back to the main thermostat screen or wait for the screen to automatically time out.

## System Modes

- **OFF Mode:** System is off. No heating or cooling will come on. If system was on, it will turn off immediately.
- **HEATING Mode:** Only heating will occur.
- **COOLING Mode:** Only cooling will occur.
- **AUTO Mode:** Heating or cooling will come on according to the heating and cooling setpoints. The system will automatically switch between heating and cooling modes as needed to maintain the setpoints.

## ! Special Heat Pump Mode: Emergency Heat

**EHEAT Mode:** An additional system mode, "EHEAT" for Emergency Heat will be displayed if the HVAC system type is set to Heat Pump. If there is a compressor failure with the Heat Pump system, setting the mode to EHEAT will allow the supplemental Aux heat to come on first whenever there is a call for heating. It also disables the compressor output to prevent further damage to the HVAC system.

# Setting Fan Mode and System Status Indicators

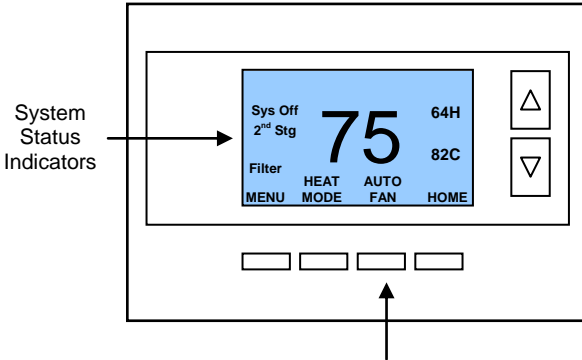

Press the Fan button to change the Fan mode

- AUTO FAN: Fan automatically operated by the HVAC system.
- FAN ON: Manual Fan mode. Fan stays on until mode is changed back to Auto.

## Optional Fan Mode

**Fan Cycler.** If the Fan Cycler feature is enabled in the Installer Setup, the additional fan mode "Cycle" will be shown in the Fan Mode menu. This mode cycles the fan on and off continuously for fresh air ventilation according to the settings in the Installer Setup.

## System Status Indicators

When the main thermostat screen is displayed, the on-screen labels indicate the following.

### System Operation mode indicator

"SYS OFF"<sup>1</sup> displayed > System is OFF

"SYS MOT"<sup>1</sup> displayed > System is OFF and Minimum Off Time (MOT) delay On is active

"HEAT ON" displayed > System is ON and heating

"COOL ON" displayed > System is ON and cooling

"HEAT MRT"<sup>2</sup> displayed > System is ON and heating. Minimum Run Time (MRT) delay off is active.

"COOL MRT" displayed > System is ON and cooling. Minimum Run Time (MRT) delay off is active.

### Staging display

"2<sup>nd</sup> Stg" displayed > Stage 2 heating or cooling is ON

"Aux Heat" displayed > Stage 3 heating is ON

For Heat Pump systems only: "EHEAT" > emergency heat mode active

### Home/Away display

**Home** mode is active (current setpoints are being used)

**Away** setback mode is active (setback setpoints are being used)

### System Alerts

Alert Text displayed > Specific alert text (Filter or Maintenance Timer)

Notes 1 and 2: See MOT and MRT descriptions on page 7

## Menu Selection

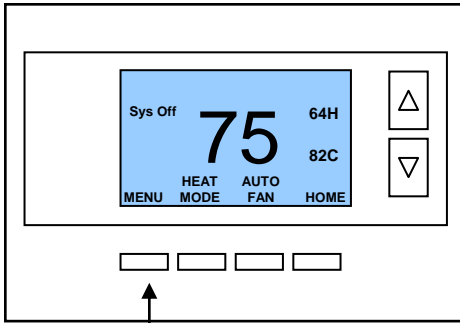

Press Menu button to go to the main menu screen

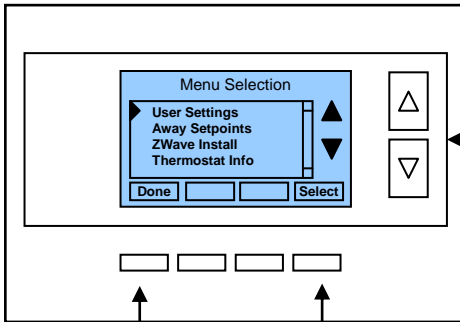

Use the UP/DOWN buttons to select the desired menu item

Press DONE to go back to the main thermostat screen

Press SELECT to go to the menu item screen

## Main Menu Items

- User Settings > set various user preferences
- Away Setpoints > show and set the heating and cooling setback setpoints
- ZWave Install > ZWave installation
- Thermostat Info > displays thermostat setup info

## User Settings menu items

- Filter Service > go to the filter timer setup screen
- Maint Service > go to the maintenance timer setup screen
- Screen Timeout > sets the time in seconds to switch to the minimized screen
- F/C Settings > go to the F/C mode selection screen
- Sensor Calibration > go to the sensor calibration screen
- Backlight/Display > go to the backlight and display setup screen

**Filter Service:** Go to the Filter Service Screen. Sets/resets the filter timer/alert. Shows filter runtime in hours and the service interval alert in hours (typically 300 hrs) Change the service interval with the +/- buttons. Reset the service alert after you have changed the filter.

**Maint Service:** Go to the Maintenance Service Screen. Sets/resets the maintenance timer/alert.

The Maintenance Service screen will show the accumulated Heat and Cool runtime hours as well as the Service Interval that will be used to trigger a Maintenance alert.

Service interval is 3000 hours. Use the +/- buttons to adjust service interval. Press reset to clear the service alert and reset the runtimes to zero.

When the combined HEAT and COOL Runtime hours equals the Service Interval hours, the Red LED will flash along with a "Maint" message to remind you your HVAC system may require periodic maintenance. Pressing the Menu button will take you to the Filter Service screen. The Reset button can be pressed and the HEAT and COOL Runtime values will be reset to zero.

**Screen Timeout: Minimized Screen.** Set the display timeout time in seconds. Options are 0 or 15 to 120 (default set to 0 seconds). This is the time before the main thermostat screen reverts to the minimized temperature only display screen, after the last button press. The Minimized Screen feature is disabled by setting this time to "0".

**!** Any button press will restore the main thermostat screen display.

**F/C Settings:** Go to the F/C Settings Screen. Select which temperature display mode you desire, Fahrenheit (F) or Celsius (C).

**Sensor Calibration:** Go to the Sensor Calibration Screen. This screen allows you to adjust the calibration of the internal sensor. You can change the temperature calibration by +/- 7 degrees using the + and – buttons

When the Sensor Calibration screen is selected it will show the current temperature calibration and the current number of degrees of offset being applied (typically 0). If the sensor's actual temp is (74) with 0 degrees of offset and you want it to show 75, then press "+" to add 1 deg and it will show (75).

**!** You can refresh the info on this screen by pressing the right hand (blank) button.

When you close this screen, it may take a few seconds for the temperature displayed on the main thermostat screen to update to the new temperature selected.

**Backlite/Display:** Go to the Backlite/Display settings screen. This menu allows you to set the backlight timeout period and adjust the display contrast.

**Backlite Timeout:** Sets the time from last button press that the backlite will timeout and turn off. The timeout value is adjustable from 0 or 20 to 120 seconds. If set to "0", the Backlite will always be ON. If set in the range of 20 to 120 seconds, the Backlite will turn OFF after the selected time expires.

**Contrast:** Sets the contrast level of the LCD display, adjustable from 0 to 20. Use this control to adjust the darkness of the display. To light and the display looks faded, too dark and dark lines will appear in the display. Typically 10-15 is a good setting. Adjust as needed.

## Away Setpoints

Away setpoints are used when the thermostat is set to the setback or away mode.

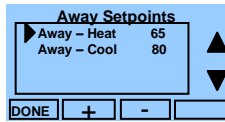

Use up/down buttons to select setpoint to change

Press DONE to store the setting and exit back to the main menu

Use +/- buttons to increase or decrease the temperature

## Thermostat Info

The Thermostat Info screen displays the current configuration of the Z-WAVE Thermostat. This information is useful for quick check of firmware versions and HVAC system setup. It also shows the ZWave network setting.

Thermostat information displayed is:

- **Thermostat** - Model and firmware version number.
- **Z-Wave Settings** – ZWave Firmware version, ZWave Node ID, ZWave Home ID
- **System Type** - Standard or Heat Pump HVAC system
- **Fan Type** – if HVAC type = Standard: Gas or Elect  
**OR**
- **Changeover** – if HVAC type = Heat Pump: Changeover with cool or changeover with heat.

### Thermostat Info Screen

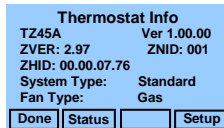

Press **Done** button to exit back to Main Menu screen.

Press and Hold **Status** button to enter Relay Status screen.

Press and Hold **Setup** button to enter Mechanical Settings screen. **NOTE:** For qualified service personnel only, see Page 3 of Installation Guide.

## Thermostat Operation

### Minimum Run Time (MRT)

The thermostat has a Minimum Run Time after the start of any heating or cooling call. This minimum run time assures even heating and cooling cycles. The MRT delay will keep the system on even if it reaches setpoint or you change the setpoint to a temperature that would satisfy the call, until the MRT expires. Changing the Mode to OFF will cancel the MRT and the system will turn off immediately. The MRT can be adjusted in the Installer Settings menu of the thermostat.

*Note: The MRT status is shown in the thermostat System Status on-screen labels.*

### Minimum Off Time (MOT)

The thermostat has a Minimum Off Time after any heating or cooling call is finished. This delay prevents rapid heating/cooling cycles and also provides "short cycle protection" for compressor calls. This delay may be noticeable when you change a setpoint and it does not respond immediately due to another call that has recently completed and the MOT delay timer is preventing the system from restarting. The MOT delay time can be adjusted in the Installer Settings menu of the thermostat. There is a minimum of 5 minutes delay to assure compressor protection.

*Note: The MOT status is shown in the thermostat System Status on-screen labels.*

## Z-Wave® Installation

Z-Wave controllers from various manufacturers may support the Z-Wave Thermostat General V2 Device class used by the RCS Z-WAVE Thermostat. The following procedure will allow the thermostat to be added to a Z-Wave network.

**General Programming Procedure** (for controllers supporting the thermostat device class):

1. **Set your primary controller to Include, Add or Install mode**, to add the thermostat as a node on your network (see your controller's user manual for detailed instructions).
2. **In the Thermostat's Main Menu, scroll down to the ZWave Install item.** Select the item.
3. **When prompted by your Z-Wave controller, Press the YES button** in the ZWave Install screen.

Your controller will indicate the thermostat was successfully added to its network (see your controller's user manual for details). Also you can check if the thermostat was successfully added to the network by checking the ZHID (Home ID) and ZNID (Node ID) located in the **Thermostat Info** screen.

For other specific tasks such as adding the thermostat to Scenes or Groups, or deleting the thermostat from an existing network, use the Z-Wave Install procedure.

**Note:** Before adding the thermostat to a Z-Wave Network, check that it does not already belong to one by viewing the Node ID (ZNID) located in the **Thermostat Info** screen. An un-installed thermostat should show zeros for the Node ID (000). Consult your controller's user manual for details on removing a device from a Z-Wave network.

### Setback Mode Operation

If your controller does not support full thermostat device class functions, it may still be able to control the energy saving AWAY mode of the thermostat through BASIC\_SET commands.

Sending the BASIC\_SET (Value = 0x00), the thermostat will go into the AWAY mode and use the predefined AWAY setback setpoints. These setpoints are set in the Main Menu Away Setpoints item.

Sending the BASIC\_SET (Value = 0xFF), the thermostat will revert back to the Home mode it was in before the BASIC\_SET (Value = 0x00) command was sent.

Note that when the BASIC\_SET commands are sent, the TZ45 will momentarily display the new mode.

### Inclusion and Exclusion

Inclusion or exclusion is started by putting the controller into add node or remove node state and performing the General Programming Procedure outlined above. As part of the process, the thermostat sends a node information frame at normal power.

Low power inclusion or low power exclusion is not possible.

# FCC

## INFORMATION TO USER

This device complies with Part 15 of the FCC Rules. Operation is subject to the following two conditions: (1) This device may not cause harmful interference, and (2) This device must accept any interference received, including interference that may cause undesired operation.

This equipment has been tested and found to comply with the limits for Class B Digital Device, pursuant to Part 15 of the FCC Rules. These limits are designed to provide reasonable protection against harmful interference in a residential installation. This equipment generates and can radiate radio frequency energy and, if not installed and used in accordance with the instructions, may cause harmful interference to radio communications. However, there is no guarantee that interference will not occur in a particular installation. If this equipment does cause harmful interference to radio or television reception, which can be determined by turning the equipment off and on, the user is encouraged to try to correct the interference by one or more of the following measures.

- Reorient or relocate the receiving antenna
- Increase the separation between the equipment and receiver
- Connect the equipment into an outlet on a circuit different from that to which the receiver is connected
- Consult the dealer or an experienced radio/TV technician for help

Any changes or modifications not expressly approved by the party responsible for compliance could void the user's authority to operate the equipment.