

# 3G4010CF/LE4010CF

---

Fire Alarm Communicator for Central Station Service Fire Alarm - Commercial RF  
Communicator Signaling Devices

## INSTALLATION MANUAL



---

**Warning:** This manual contains information on limitations regarding product use and function and information on the limitations as to liability of the manufacturer. The entire manual should be carefully read.

---

# Contents

---

|   |           |
|---|-----------|
| <b>Section 1: Introduction</b> .....  | <b>6</b>  |
| 1.1 Features .....  | 6         |
| 1.2 Technical specifications .....  | 7         |
| 1.2.1 Standard battery capacity .....   | 8         |
| <b>Section 2: Identification of parts</b> .....   | <b>9</b>  |
| <b>Section 3: Installing the 3G4010CF/LE4010CF</b> .....  | <b>11</b> |
| 3.1 C24 communications enrollment .....   | 11        |
| <b>Section 4: Connecting the 3G4010CF/LE4010CF</b> .....  | <b>14</b> |
| 4.1 Power supply module .....   | 14        |
| <b>Section 5: Status LEDs</b> .....   | <b>15</b> |
| 5.1 Operating modes .....   | 15        |
| 5.1.1 Normal mode .....   | 15        |
| 5.1.2 Service mode .....  | 16        |
| 5.1.3 Swinger shutdown in service mode .....  | 16        |
| <b>Section 6: Operating principles</b> .....  | <b>17</b> |
| 6.1 Simulated landline mode .....   | 17        |
| 6.2 Panel transmission monitoring (PTM) .....   | 17        |
| 6.3 Cellular communications sequence .....  | 17        |
| 6.4 Inputs .....  | 18        |
| 6.5 Outputs .....   | 18        |
| 6.5.1 Activating the outputs .....  | 18        |
| 6.6 Reporting codes .....   | 19        |
| 6.7 Swinger shutdown - only used on model LE4014CF .....  | 19        |
| 6.7.1 Swinger shutdown for zone inputs (Software Version 5.12+) - only used on model LE4014CF ..... | 20        |
| 6.8 Hardware default .....  | 20        |
| 6.9 Communicator reset/update .....   | 20        |
| 6.10 Low power radio shutdown .....   | 21        |
| 6.11 Phone number call direction .....  | 21        |
| <b>Section 7: Troubleshooting guide</b> .....   | <b>22</b> |
| <b>Section 8: 3G4010CF/LE4010CF wiring diagrams</b> .....   | <b>26</b> |

## Safety information

### IMPORTANT

The equipment is fixed, wall-mounted and shall be installed in the position specified in these instructions (see Figure 1: Parts). The equipment enclosure must be fully assembled and closed, with all the necessary screws/tabs and secured to a wall before operation. Internal wiring must be routed in a manner that prevents:

- Excessive strain on wire and on terminal connections
- Loosening of terminal; connections
- Damage of conductor insulation

### Never install this equipment during a lightning storm!

Instruct the end-user to:

- Not attempt to service this product. Opening or removing covers may expose the user to dangerous voltages or other risks. Any servicing shall be referred to trained service persons only.
- Use authorized accessories only with this equipment.

Do not dispose of the battery in fire or water. Disposing of the battery in a fire will cause rupture and explosion.

Do not dispose of the waste battery as unsorted municipal waste. Consult your local regulations and /or laws regarding recycling with regard to this lead-acid battery. Doing so will help protect the environment. Some of the materials that are found within the battery could become toxic if not disposed of properly and may affect the environment.

This equipment, 3G4010CF/LE4010CF, is fixed and shall be installed by Service Persons only (Service Person is defined as a person having the appropriate technical training and experience necessary to be aware of hazards to which that person may be exposed in performing a task, and of measures available to minimize the risks to that person or other persons). It shall be installed and used within an environment that provides the pollution degree max 2, over voltages category II, in non-hazardous, indoor locations only. This manual shall be used with the Installation Manual of the relevant alarm control panel. All instructions specified within that manual must be observed.

The performance of the 3G4010CF/LE4010CF depends greatly on cellular network coverage. Therefore, it should not be mounted without first performing placement tests to determine the best location for reception (minimum of one green LED ON). Optional antenna kits – LTE-8ANT, LTE-15ANT, LTE-25ANT, LTE-50ANT (8ft/2.4m, 15ft/4.6m, 25ft/7.6m or 50ft/15.2m) – are available.

## Approvals information

### NOTICE TO USERS, INSTALLERS, AUTHORITIES HAVING JURISDICTION AND OTHER INVOLVED PARTIES

This product incorporates field-programmable software. In order for the product to comply with the requirements in the Standard for Control Units and Accessories for Fire Alarm Systems, UL 864, certain programming features or options must be limited to the specific values or not used at all as indicated below.

| Program Feature or Option | Permitted in UL 864 (Y/N?) | Possible Settings     | Settings Permitted in UL 864 |
|---------------------------|----------------------------|-----------------------|------------------------------|
| Supervision               | Yes                        | 5 minutes /60 minutes | 5 minutes (see note below)   |
| Inputs/Outputs            | Yes                        | Fire/Burg signals     | Fire related signals only    |
| SMS Remote Control        | No                         | Enable/Disable        | Disable                      |

---

**Note:** This product has been tested in accordance with UL 864 9th edition. According to this edition of the standard, the supervision window for reporting single-technology communicator trouble shall be set to five minutes. However, the product can be installed in accordance with the requirements of NFPA72 2013 edition, which allows for a 60-minute supervision window.

**Note:** Encryption shall be enabled for active communications.

**Notes for using Private, Corporate and High Speed Data Networks:** Network access and domain access policies shall be set to restrict unauthorized network access, and "spoofing" or "denial of service" attacks. Select the internet service providers that have redundant servers/systems, back-up power, routers with firewalls enabled and methods to identify and protect against "denial of service" attacks (i.e., "spoofing"). For UL Residential Fire and Burglary installations, the 3G4010CF/LE4010CF is listed as a sole means of communication or as a back up when used in conjunction with a POTS line (dialer).

**For ULC Residential Fire and Burglary installations,** the 3G4010CF/LE4010CF is listed as a sole means of communication or as a back up when used in conjunction with a POTS line (dialer).

**For UL Commercial Burglary installations,** the 3G4010CF/LE4010CF is listed as a sole means of communication (supervision window of 200s required at monitoring station) or as a back-up when used in conjunction with a POTS line (dialer). The 3G4010CF/LE4010CF shall be powered from any compatible listed control unit or compatible listed power supply that complies with the ratings specified on page 1. The power supply shall be listed for burglary applications and provide a minimum of 4 hours standby power capabilities. An example of a suitable listed compatible control unit is the DSC Model HS2128 with an AUX output rated 11.1 - 12.6VDC. An example of a suitable Listed power supply is DSC Model HSM2204 with an AUX output rated 11.6 - 12.6VDC.

**For ULC Commercial Burglary Monitoring Installation the 3G4010CF/LE4010CF can be used in the following configurations:**

1. Active communication system with 180 seconds supervision and heartbeat sent to signal receiving centre every 90 seconds.
2. Passive communication system line security P1 (single communication channel) or line security P2 (used as backup in conjunction with another communication path (e.g. DACT)). There is no heartbeat sent in this configuration, only periodic test transmissions.

Every 24 hours, a test transmission must be sent to the signal receiving centre over each communication path. Each communication path shall be monitored for integrity (DACT shall have line monitoring enabled and 3G4010CF/LE4010CF shall have cellular connection supervision enabled). For Level P2, the working communication path shall report the failure of the other channel within 240 seconds.

**For ULC Commercial Fire Monitoring Installations the 3G4010CF/LE4010CF can be used in the following configurations:**

1. Active communication system with 180 seconds supervision (Heartbeat sent to signal receiving centre every 90 sec.).
2. Passive communication system in conjunction with a another communication path (e.g. DACT) (there is no heartbeat sent in this configuration, only periodic test transmission ). Alarm signals must be sent simultaneously over both communication paths (Cellular and DACT). Every 24 hours, a test transmission must be sent to the signal receiving centre over each communication path. Each communication path shall be monitored for integrity (DACT shall have line monitoring enabled and shall have cellular connection supervision enabled).

**For ULC Commercial Burglary Monitoring Installations the 3G4010CF/LE4010CF can be used in the following configurations:**

1. Active communication system with 180 seconds supervision and heartbeat sent to signal receiving centre every 90 sec.
2. Passive communication system line security P1 (single communication channel) or line security P2 (used as backup in conjunction with another communication path (e.g. DACT)). There is no heartbeat sent in this configuration, only periodic test transmissions. Every 24 hours, a test transmission must be

sent to the signal receiving centre over each communication path. Each communication path shall be monitored for integrity (DACT shall have line monitoring enabled and shall have cellular connection supervision enabled). For Level P2 the working communication path shall report the failure of the other channel within 240s.

**For Commercial Fire Monitoring Installations, the 3G4010CF/LE4010CF can be used in the following con-figurations:**

1. Standalone communicator, single communication technology - 5 minute supervision (heartbeat sent to supervising station every 90 seconds).
2. Back-up communicator line for a DACT (dual communication technology, no heartbeat sent). Alarm sig-nals must be sent first over the primary communication path (DACT) and then, if this is known to have failed, over the secondary communication paths (other transmission technologies)
  - o Primary: Compatible listed control unit's land line to central station (primary).
  - o Secondary: 3G4010CF/LE4010CF transmission through wireless network to central station.

Every 24 hours, a check-in signal must be sent to the central station over the primary dialer. The 3G4010CF/LE4010CF sends a heartbeat test transmission to the supervising station every 24 hours. Each com-munication path shall be monitored for integrity (DACT shall have line monitoring enabled and 3G4010CF/LE4010CF shall have cellular connection supervision enabled).

Power for model LE4010 shall be provided by one of the two compatible power supplies:

- a. Mircom Model – DTC-300A(W)(R), digital alarm communicator transmitter
- b. Simplex control panel 4100U with converter module 4100-5152 installed

**Note:** Wiring between the 3G4010CF/LE4010CF and FACP/Power Supply shall be made in the same room, in metal conduit and not longer than 20ft.

## Section 1: Introduction

This manual covers two communicator models, the 3G4010CF and the LE4010CF. They are referred to throughout this manual as 3G4010CF/LE4010CF unless otherwise indicated.

The 3G4010CF/LE4010CF are wireless communicators for UL commercial fire and/or burglary applications.

Both models send alarm system information to a Sur-Gard System I-IP, II, III, IV or 5 receiver. The 3G4010CF uses the 3G (HSPA) or 2G (GPRS) cellular network. The LE4010CF uses the LTE or 3G wireless network.

This product is UL listed under requirements of UL864 9th Edition and UL1610 Standards as a Fire Alarm Communicator for central station service fire alarm – commercial and it can be installed in certified installations in accordance with the requirements of UL827 Standard and NFPA72 2002 (Section 8.5.4 Other Transmission Technologies), NFPA72 2007 (Section 8.6.4 Other Transmission Technologies) or NFPA72 2010 Code (Section 26.6.3.1)

These products are also listed under ULC-S559 and ULC-S304 for installation in accordance with ULC-S302 and ULC-S561.

### 1.1 Features

- Complete solution CF kit includes tamper protection output, listed power supply and battery standby capability for 24 hours.
- Dual-band UMTS/HSPA; Penta-Band LTE ( LE4010CF); Quad-Band GSM/EDGE Radio
- Advanced Carrier Selection
- Bi-color Wireless Signal Strength Indicator
- 3G (3G4010CF/LE4010CF) or LTE (LE4010CF) Internet communication with Sur-Gard SG-System I-IP / II / III / IV / 5
- Compatible with listed alarm control panels that have an integrated DACT and support a 4-digit or 10-digit Contact ID communication format as described in SIA DC-05 Standard and the SIA DC-03 standard for 300 baud. Example of suitable compatible alarm panels:  
DSC Models PC1864, PC1832, PC1616, PC4020. For LE4010CF, the following alarm panels are also compatible: HS2128, HS2064, HS2032, HS2016
- Panel Transmission Monitoring for up to four phone numbers
- Simulates landline
- Switches automatically to the 3G (HSPA) or 2G (GPRS) / LTE or 3G (LE4010CF) network in the event of landline trouble (e.g., line down)
- Four Programmable (NO/NC/SEOL) Inputs
- Contains one 12V - 7 Ah battery
- Case Tamper Input
- Landline overvoltage protection
- Four Programmable Outputs
- DLS support for status, firmware updates
- Remote Firmware Upgrade
- Remote Diagnostics
- Panel Format Detection
- Phone number call direction
- Easy enrollment with C24 Communications via web or mobile interface

## 1.2 Technical specifications

| <b>Power Supply Ratings</b>                           |  |
|---|--|
| Input Voltage:  | 120V/60Hz/0.3A   |
| Standby Voltage:                                      | 12V/7AH  |
| Standby Time:   | 24h (NSC) plus 5 minutes alarm   |
| Low Battery Trouble Indication Threshold:             | 11.5VDC  |
| Battery Deep Discharge Protection (cut-off):          | 9.5VDC   |
| Battery Type:   | sealed, rechargeable type, rated 12V/7Ah<br>(for 24hr standby time)        |
| Battery charging voltage:                             | 13.75Vdc   |
| Battery charge current:                               | 700mA (maximum)  |
| NOTE: Battery must be replaced every 3-5 years.       |  |
| Operating frequency - 2G (GSM/GPRS/EDGE):             | 850/1900MHz  |
| Operating frequency - 3G (UMTS/HSPA):                 | 850/1900MHz  |
| Antenna gain:   | 2.0dBi   |
| <b>Environmental Specifications</b>                   |  |
| Operating temperature:                                | 0°C-49°C (32°F-120°F)  |
| Humidity:   | 93%RH Maximum (non-condensing)   |
| <b>Mechanical Specifications</b>                      |  |
| Enclosure Type  | metal, red, hardwired transformer and high voltage connection box included |
| Enclosure Dimensions:                                 | 290mm x 254mm x 75mm (11.5" x 10" x 3")                                    |
| Weight:   | 5.8Kg (12.8 lbs) (including standby battery)                               |
| <b>Simulated Telco Loop specifications (TIP/RING)</b> |  |
| On-Hook Voltage:                                      | 12Vdc  |
| Off-Hook Voltage (Maximum):                           | 35Vdc  |
| Loop Current :  | 25mA   |
| Loop Resistance :                                     | 600 Ohms   |

Table 5-1 LE4010CF Operating Frequencies

| Band    | Transmit Band (Tx) | Receive Band (Rx) |
|---------|--------------------|-------------------|
| LTE B2  | 1850 - 1910 MHz    | 1930 - 1990 MHz   |
| LTE B4  | 1710 - 1755 MHz    | 2110 - 2155 MHz   |
| LTE B5  | 824 - 849 MHz      | 869 - 894 MHz     |
| LTE B12 | 698 - 716 MHz      | 728 - 746 MHz     |
| LTE B13 | 777 - 787 MHz      | 746 - 756 MHz     |
| UMTS B2 | 1850 - 1910 MHz    | 1930 - 1990 MHz   |
| UMTS B5 | 824 - 840 MHz      | 869 - 894 MHz     |

### 1.2.1 Standard battery capacity

The calculation for battery capacity is based on 200mA standby current for 24 hours plus a five minute alarm at 400mA or 600mA (if the 4 PGM outputs are also activated)

The requirements are as follows:

200mA x 24h = 4800mAh capacity for standby

400mA x 5/60h = 33.33mAh capacity for alarm condition

Total = 4833.33 mAh needed for 24h and five minutes alarm transmission. The supplied battery is 7Ah.



## Section 2: Identification of parts

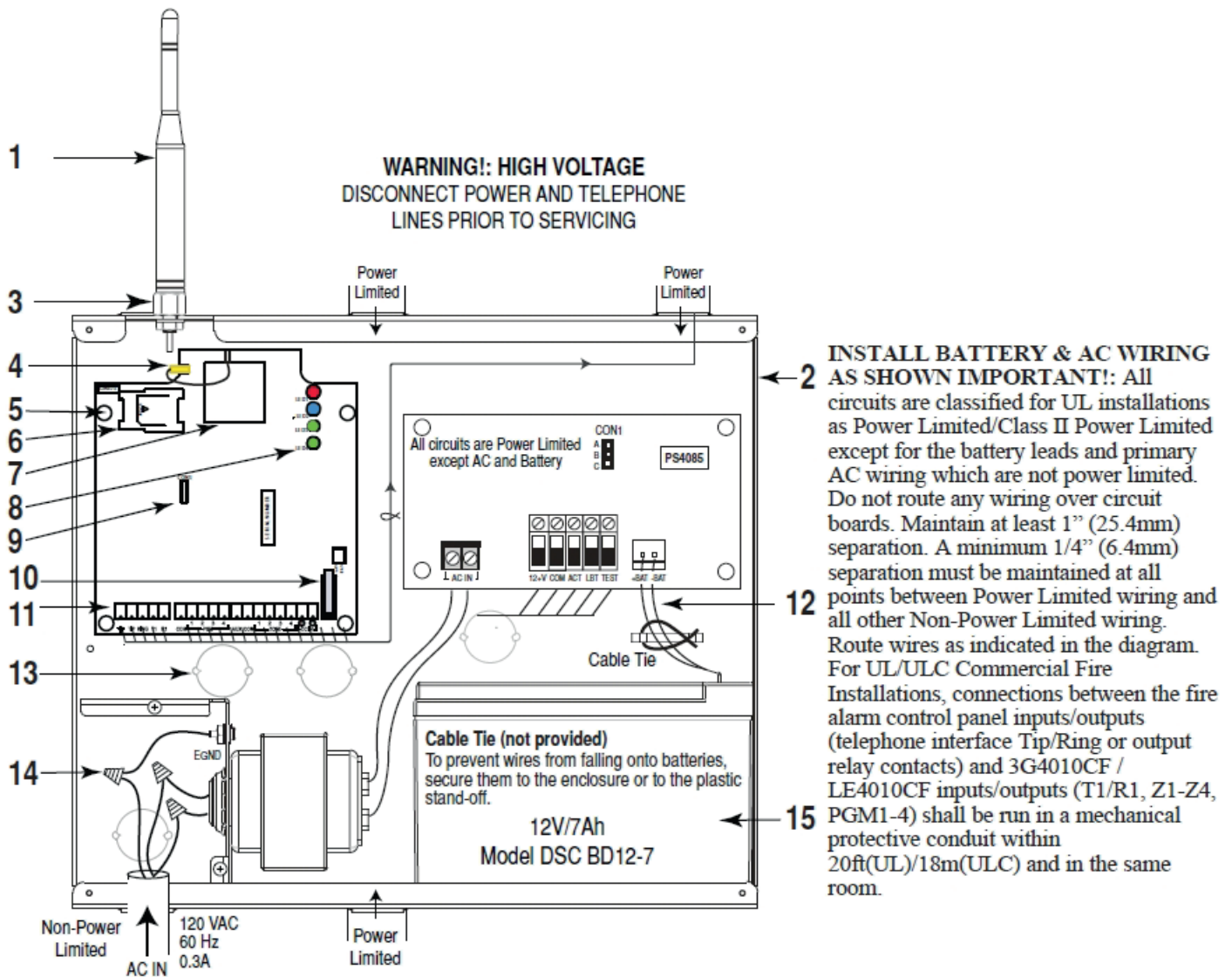

| Parts |                           |
|-------|---------------------------|
| 1     | 3G Antenna                |
| 2     | Metal Casing              |
| 3     | Antenna Mounting Hardware |
| 4     | Antenna Connector         |
| 5     | Anchor Screw Holes (3mm)  |
| 6     | SIM Card Holder           |
| 7     | 3G (HSPA) Radio Module    |
| 8     | Status LEDs               |
| 9     | PC-Link Connector         |
| 10    | Tamper Switch             |
| 11    | Terminal Blocks           |
| 12    | Battery Leads             |
| 13    | Cable Entry               |
| 14    | Earth Ground Wire         |
| 15    | 12V Battery               |

**Note:** Connection of metal-clad cable, conduit, metal raceway or the like is permitted as a means for grounding. Use the supplied star-washers to secure the mains connection box cover and the front cover of the enclosure.

**Note:** All circuits are classified for UL installations as Power Limited/Class II Power Limited except for the battery leads which are not power limited. Do not route any wiring over circuit boards. Maintain at least 1" (25.4mm) separation. A minimum 1/4" (6.4mm) of separation must be maintained at all points between Power Limited wiring and all other non-Power Limited wiring. Route wires as indicated above.

## Section 3: Installing the 3G4010CF/LE4010CF

### 3.1 C24 communications enrollment

The 3G4010CF/LE4010CF requires enrollment with C24 Communications to operate. For more information, please visit [www.connect24.com](http://www.connect24.com), contact C24 Communications customer service at 1-888-251-7458 (US) / 1-888-955-5583 (Canada) or contact the central station to inquire if they are a C24 Communications Master Reseller.

**Note:** Enrollment with C24 Communications should be performed before turning on the 3G4010CF/LE4010CF unit.

Before inserting or removing the SIM card, please ensure the unit is turned off.

#### Step 1 - Initialize the 3G4010CF/LE4010CF with C24 Communications

The 3G4010CF/LE4010CF can be initialized with C24 Communications by:

web - [www.connect24.com](http://www.connect24.com)

mobile - [m.connect24.com](http://m.connect24.com)

To complete enrollment, a C24 profile, installer ID/PIN (or web credentials) and the 20-digit SIM number are required.

**Note:** The SIM activation process with the cellular carrier typically takes between five and ten minutes to complete.

#### Step 2 - Determine Best Signal Location





1. Remove the screws and the front cover of the 3G4010CF/LE4010CF metal enclosure [1].
2. Fit the antenna [2] (ensure that the bolt [3] is fastened tightly).
3. Connect the antenna to the 3G Radio [5] and ensure the connector is secure.

**Note:** Before inserting or removing the SIM card, please ensure the unit is powered down.

4. Ensure the SIM card is placed in its socket [6].
5. Power up the 3G4010CF/LE4010CF module [4] Use a DC power source rated 12V/0.7A connected to +/- 12V terminals [9]

#### Step 2a – SIM Card Is Activated.





The red LED is on solid, the blue LED is off and the signal strength LEDs display the average signal strength. In this state, the 3G4010CF/LE4010CF is registered to the network.

|  |   |  |   |
|--|---|--|---|
| <br>Red | <br>Blue | <br>Yellow/Green<br>(Top) | <br>Yellow/Green<br>(Bottom) |
| ON   | OFF   | -  | -   |

If the signal strength is too low (bottom signal LED off or flashing), the 3G4010CF/LE4010CF will proceed to **Step 3**: scan for, and attach to, carriers with sufficient signal strength. If the 3G4010CF/LE4010CF is connected to a carrier with sufficient signal strength (minimum of bottom signal strength LED on solid), it proceeds to **Step 4**.

#### Step 2b – SIM Card Is Not Activated





The red LED flashes, the blue LED is off and the signal strength LEDs display the average signal strength.

|  |   |  |   |
|--|---|--|---|
| <br>Red | <br>Blue | <br>Yellow/Green<br>(Top) | <br>Yellow/Green<br>(Bottom) |
| FLASHING   | OFF   | -  | -   |

In this state, the 3G4010CF/LE4010CF is unable to register to the network because it is inactive. The signal strength indicated is from **any** nearby cell tower (including cellular towers belonging to non-roaming partners) and does **not** necessarily reflect the signal strength of the intended network. The 3G4010CF/LE4010CF remains in this state until the SIM is activated. Once the SIM is activated, the 3G4010CF/LE4010CF proceeds to **Step 2a**.

**Step 3 – Carrier Scanning Due To Insufficient Signal Strength**





The 3G4010CF/LE4010CF scans the surrounding network and connects to the carrier to provide a signal strength of at least 7 CSQ. While this action is being performed, all four LEDs activate to show a scanning sequence in progress. The LEDs cycle from top to bottom and then bottom to top until the 3G4010CF/LE4010CF connects to a carrier with a signal strength above 7 CSQ (minimum of bottom signal strength LED on solid).

| <br>Red | <br>Blue | <br>Yellow/Green (Top) | <br>Yellow/Green (Bottom) |
|--|---|---|--|
| FLASH ON   | OFF   | OFF   | OFF  |
| OFF  | FLASH ON  | OFF   | OFF  |
| OFF  | OFF   | FLASH ON  | OFF  |
| OFF  | OFF   | OFF   | FLASH ON   |
| OFF  | OFF   | FLASH ON  | OFF  |
| OFF  | FLASH ON  | OFF   | OFF  |
| FLASH ON   | OFF   | OFF   | OFF  |

Once this is completed, the 3G4010CF/LE4010CF proceeds to **Step 4**.

**Step 4 - Acquire C24 Communications Programming**





The red LED is on solid and the blue LED flashes. The flashing blue LED indicates that the 3G4010CF/LE4010CF has requested programming from C24 Communications and is waiting for a response.

| <br>Red | <br>Blue | <br>Yellow/Green (Top) | <br>Yellow/Green (Bottom) |
|--|---|---|--|
| ON   | FLASHING  | -   | -  |





Once remote programming is completed, the blue LED switches to solid and the 3G4010CF/LE4010CF proceeds to **Step 5**.

**Step 5 – Receiver Initialization**





The red and blue LED's are both on solid and the signal strength LEDs are off.

| <br>Red | <br>Blue | <br>Yellow/Green (Top) | <br>Yellow/Green (Bottom) |
|--|---|---|--|
| ON   | ON  | OFF   | OFF  |





When the 3G4010CF/LE4010CF sends a request to communicate with the central station, the top signal strength LED begins flashing.

|  |   |  |   |
|--|---|--|---|
| <br>Red | <br>Blue | <br>Yellow/Green<br>(Top) | <br>Yellow/Green<br>(Bottom) |
| ON   | ON  | FLASHING   | OFF   |





When the central station communicates back to the 3G4010CF/LE4010CF, the top signal strength LED turns on solid.

|  |   |  |   |
|--|---|--|---|
| <br>Red | <br>Blue | <br>Yellow/Green<br>(Top) | <br>Yellow/Green<br>(Bottom) |
| ON   | ON  | ON   | OFF   |

When the 3G4010CF/LE4010CF sends a request to communicate to the next central station, the bottom signal strength LED begins flashing...

|  |   |  |   |
|--|---|--|---|
| <br>Red | <br>Blue | <br>Yellow/Green<br>(Top) | <br>Yellow/Green<br>(Bottom) |
| ON   | ON  | ON   | FLASHING  |

...and turns on solid when it receives a communication back from the central station.

|  |   |  |   |
|--|---|--|---|
| <br>Red | <br>Blue | <br>Yellow/Green<br>(Top) | <br>Yellow/Green<br>(Bottom) |
| ON   | ON  | ON   | ON  |

If at least one of the central stations does not respond back to the communicator, the signal strength LED corresponding to that central station turns off. Once the initialization sequence is complete, the 3G4010CF/LE4010CF switches to steady state operation.

**Step 6 - Mount the 3G4010CF/LE4010CF**

1. Power down the 3G4010CF/LE4010CF by removing the DC power source and battery leads.
2. Using the cabinet, mark the four screw locations. Drill the anchor screw holes.

**Note:** Check for cable conduits and water pipes before drilling.

3. Using anchor screws (not provided), mount the cabinet to the wall.
4. Run the cables through the cable entry [13] or through the cabinet knockouts.
5. Complete the connections on the terminal blocks [11].

**Note:** Ensure that power and Telco circuit connections are made only after the cabinet has been secured to the building or structure, and has been connected to the protective earth ground. Descriptions of the terminals can be found in the 'Connecting the 3G4010CF/LE4010CF' section.

6. Reattach the front cover [1] securely to the cabinet.

**Note:** Please refer to the end of this manual for wiring diagrams.

## Section 4: Connecting the 3G4010CF/LE4010CF

**⏏ (1) Earth Ground** - This terminal must be connected to the Mains Earth, in order to comply with the Telecommunications Network Safety Standards (Overvoltage Protection Requirements).

**TIP (2) / RNG (3) External Telephone Line** - These terminals must be connected directly to the incoming telephone line.

**T1 (4) / R1 (5) Internal Telephone Line** - These terminals must be connected to the TIP and RING of the control panel.

**COM (6,12) Common** - This terminal is connected internally to Power Ground.

**PGM1 (7), PGM2 (8), PGM3 (9), PGM4 (10) Programmable Open-collector Outputs** - These outputs can be activated by programmed events. Refer to 'Activating the Outputs' for details. The maximum current sink of each output must not exceed 50mA.

**AUX+ (11) Auxiliary Output** - 9 to 14VDC Output, 100mA PTC Protected. This terminal is used in conjunction with the PGM outputs to activate a supervision relay. Recommended relay: DSC Model RM-2 or RM1C.

**Note:** Electrical current drawn from this terminal is drawn directly from the power supply. This must be added to the 3G4010CF/LE4010CF current when determining the total draw on the host panel or power supply.

**Z1-Z4 (13-14-15-16) Programmable Inputs** - These terminals can be set up to trigger events. Refer to 'Inputs' for details.

**+12V (19), -12V (20) Device Power Supply** - These terminals must be connected to the output of the power supply [10]. When the connections are completed, connect the Red and Black wires [12] to 12V, 7Ah battery [13].

### 4.1 Power supply module

**AC** - Supervised input, connect the secondary of the transformer to these terminals. Connect the primary of the transformer to a dedicated electrical circuit.

**DC IN ⊕ (17), ⊖ (18)** - Special application output circuit, power limited, connect to 3G4010CF/LE4010CF power input circuit. Connect the +12V output to +12V input on the 3G4010CF/LE4010CF module and the COM output to the - 12V input on the 3G4010CF/LE4010CF module.

**ACT (AC Trouble)** - This open collector output activates when an AC Trouble is detected: Rated 50mA.

**Note:** AC Trouble output shall be connected to an input on the alarm control panel that provides immediate local annunciation and delayed remote transmission for 1 to 3 hours. If such input is not able to provide the delay for AC loss transmission, input 1 of the 3G4010CF/LE4010CF can be used. When Input 1 is triggered, the 3G4010CF/LE4010CF will immediately annunciate an AC trouble by flashing the RED status LED 9 times, and will delay the AC loss event transmission by one hour.

**LBT (Battery Trouble)** - This open collector output activates when a Battery Trouble condition is detected: Rated 50mA.

**TEST (Charger Trouble)** - This open collector output activates when the charging circuit is in a trouble condition: Rated 50mA.

These outputs shall be connected to zone inputs of an alarm control panel in order to provide the required trouble supervision (visual and audible indication required at the control panel). The outputs are active low (switched to ground) and can be connected to a control panel directly or by using a listed supervision relay (suggested model: DSC, RM-2 or RM1C relay).





## Section 5: Status LEDs

### 5.1 Operating modes

The 3G4010CF/LE4010CF features two distinct operating modes: Normal Mode and Service Mode. The unit is in Normal Mode when the cover is on (tamper is in a restored state). The unit is in Service Mode when the cover is off (a cover tamper is present).



#### 5.1.1 Normal mode

The 3G4010CF/LE4010CF has four status LEDs. The following table describes the status LEDs when the communicator is in normal operating mode.

|   |  |
|---|--|
| <p><b>Red</b></p>                          | <p>This LED indicates trouble conditions.<br/> On (solid): Trouble Requiring Service<br/> 1 Flash: Wireless Network Trouble<br/> 2 Flashes: Battery Trouble<br/> 3 Flashes: Input Power Trouble</p>  |
| <p><b>Blue</b></p>                         | <p>This LED indicates cellular radio activity. When on (solid), a phone line trouble condition exists. This LED turns on when the interface switches to the wireless network (due to a landline trouble condition). This LED also flashes once when the 3G4010CF/LE4010CF transmits a signal and twice when it receives a kiss-off from the central station.<br/> <b>Note:</b> If the 3G4010CF/LE4010CF is programmed to be the primary communicator, the blue LED remains off, but still flashes during the signal transmission as described above.</p>                         |
| <p><b>Yellow/Green<br/>(Top)</b></p>     | <p>This LED indicates signal strength and network technology. If the 3G4010CF/LE4010CF is operating over a 2G channel (3G channel for LE4010CF), the LED is YELLOW. If the 3G4010CF/LE4010CF is operating over a 3G channel (LTE channel for LE4010 LE4010CF), the LED is GREEN. When this LED is On, the reception is optimal. This LED switches On only when the bottom LED is on.</p>   |
| <p><b>Yellow/Green<br/>(Bottom)</b></p>  | <p>This LED indicates signal strength and network technology. If the 3G4010CF/LE4010CF is operating in over a 2G channel (3G channel for LE4010CF), the LED is YELLOW. If the 3G4010CF/LE4010CF is operating over a 3G channel (LTE channel for LE4010CF), the LED is GREEN.<br/> If this LED is Off and the Red LED is On, the Wireless Network service is unavailable (NO SERVICE). This LED flashes when the Wireless Network reception is poor. If this LED is on, the 3G4010CF/LE4010CF is able to communicate with the 3G (HSPA) or 2G (GPRS) or LTE (LE4010) network.</p> |

### 5.1.2 Service mode

To view detailed trouble information on the status LEDs, the 3G4010CF/LE4010CF must be placed in Service Mode by removing the front cover. When in Service Mode, the status LEDs indicate the trouble condition as follows.

| Number of Flashes  |   | Trouble Type   |
|--|---|--|
| <br>RED | <br>BLUE |  |
| 1  | OFF   | Wireless network trouble - unable to connect to cellular network |
| 2  | OFF   | Battery trouble - battery with low voltage output                |
| 3  | OFF   | Input power trouble  |
| 1  | Flashing  | Insufficient signal strength - poor location                     |
| 2  | Flashing  | C24 suppressed trouble   |
| 3  | Flashing  | C24 communication configuration trouble                          |
| 1  | ON  | Radio/SIM trouble - radio or SIM unresponsive                    |
| 2  | ON  | Receiver not available trouble                                   |
| 3  | ON  | Supervision trouble  |
| 4  | ON  | Case tamper is open  |
| OFF  | -   | No trouble   |

### 5.1.3 Swinger shutdown in service mode - only model LE4010CF

When service mode is activated by opening the case tamper, swinger shutdown states are cleared. Swinger shutdown will not be applied to any zone inputs while service mode is active.



## Section 6: Operating principles

### 6.1 Simulated landline mode

The simulated landline provides the alarm control panel (with dialer interface) with a backup line in the event of PSTN line trouble.

**Note:** The 3G4010CF/LE4010CF must be programmed as a backup communicator for Simulated Landline mode to operate.

If the voltage on the landline terminals (TIP/RNG) drops below 2.8V for a period of between 10 and 45 seconds - depending on the alarm control panel connected to the T1/R1 terminals- the 3G4010CF/LE4010CF switches the connected telephone device to the cellular network. After waiting between 30 and 40 seconds, it checks the landline for one of the following:

- If the landline has been restored, the 3G4010CF/LE4010CF switches the connected device back to the landline, OR
- If the landline is still down, the 3G4010CF/LE4010CF continues the simulation until the landline is restored. The 3G4010CF/LE4010CF will not switch during ongoing calls.

**Note:** When the landline is down, the 3G4010CF/LE4010CF provides a dial tone to any device connected to T1 and R1, including any telephones on the premises. The phones on the premises are not, however, able to dial out over the 3G4010CF/LE4010CF.

### 6.2 Panel transmission monitoring (PTM)

The 3G4010CF/LE4010CF can also monitor the panel's attempt to communicate with the central station. If it determines that the panel is having difficulty, it switches the line to the cellular network. This feature is only active when the 3G4010CF/LE4010CF is configured as a backup communicator. This feature is in addition to the regular line voltage detection.

The 3G4010CF/LE4010CF monitors the phone line for four consecutive failed attempts within a 12-minute window. A failed attempt is assumed to have occurred when a line seizure takes place during dialing (either the alarm panel or the customer telephone), but no 1400Hz tone (Contact ID kiss-off) or 2025Hz tone (SIA kiss-off) is sent from the receiver.

Once the conditions for a failed attempt are met, the 3G4010CF/LE4010CF connects the panel to the cellular network to communicate the events. When the 3G4010CF/LE4010CF switches the line it stays in this mode until the panel hangs up. On the next event the 3G4010CF/LE4010CF restarts the error detection sequence before switching.

The 3G4010CF/LE4010CF performs this sequence on any phone number that is detected on the line. Specific central station phone numbers can be programmed into the 3G4010CF/LE4010CF if desired. Up to four, 20-digit numbers can be added to your profile at Connect 24. If programmed, the 3G4010CF/LE4010CF only looks for a Contact ID or SIA kiss-off after these numbers are dialed. A Telephone Line Monitoring trouble (PGM output activation and/or reporting code if applicable) is also activated and/or transmitted when the PTM is activated. A restoral is sent at the end of the call.

### 6.3 Cellular communications sequence

When an alarm is triggered:

- The control panel goes off-hook.
- The 3G4010CF/LE4010CF asserts a dial tone.
- The control panel dials the number of the central station. Ensure that the alarm panel inserts a minimum one second pause, or has Dial Tone Search enabled before dialing the number.
- The 3G4010CF/LE4010CF detects the DTMF dialing and stops dial tone.

**Note:** The 3G4010CF/LE4010CF is unable to decode pulse dialing.

If the panel is programmed for Contact ID format:

- The 3G4010CF/LE4010CF sends the required Contact ID dual-tone handshake to the panel.
- After receiving the handshake, the control panel transmits an alarm message in Contact ID format.
- The 3G4010CF/LE4010CF decodes and transforms the Contact ID digits into an IP packet and sends it to the central station receiver over the cellular network.
- The central station receiver acknowledges the alarm and sends a command to the 3G4010CF/LE4010CF to generate the corresponding 1400Hz Kiss-off signal for a minimum of 800 milliseconds.

After the 3G4010CF/LE4010CF generates a Kiss-off signal, it sends the next alarm or, if no further alarms need to be sent, the control panel goes on-hook.

If the panel is programmed for SIA (300 baud) format:

- The 3G4010CF/LE4010CF sends the required SIA handshake to the panel.
- After receiving the handshake, the control panel transmits an alarm message in the SIA format.
- The 3G4010CF/LE4010CF decodes and transforms the SIA events into an IP packet that it sends to the central station receiver over the cellular network.
- The central station's receiver acknowledges the alarm and sends a command to the 3G4010CF/LE4010CF to generate the corresponding 2025Hz kiss-off signal for a minimum of one second.
- After the 3G4010CF/LE4010CF generates a kiss-off signal, it sends the next alarm or, if no further alarms need to be sent, the control panel goes on hook.

**Note:** The 3G4010CF/LE4010CF automatically adjusts the order of the handshakes based on the last format the control panel used to transmit an event.

## 6.4 Inputs

The 3G4010CF/LE4010CF has four inputs that can be used to trigger specific communications. These events transmit using the Contact ID or SIA format with Inputs 1-4 reporting as [991] to [994] respectively.

Default settings are:

INPUT 1- AC LOSS

INPUT 3 - FIRE ALARM

INPUT 2 - FIRE SUPERVISORY

INPUT 4 - SYSTEM TROUBLE

Inputs can be configured as follows:

**Normally Open** - input activates when a short condition is detected between the terminal and COM

**Normally Closed** - input activates when an open condition is detected between the terminal and COM

**Single End of Line** - input activates when a short or open condition is detected between the terminal and COM and restores when a 5.6Kohm resistor is detected between the terminal and COM.

**Note:** These inputs are programmable to communicate using either the Contact ID or SIA format.

**Note:** For UL/ULC listed installations, End of Line supervision must be used for all inputs.

**Note:** When the 3G4010CF/LE4010CF is configured in land line mode, these inputs should be restricted to monitoring of trouble conditions.

## 6.5 Outputs

The 3G4010CF/LE4010CF has four programmable outputs to activate in response to the associated events.

Refer to the 3G4010CF/LE4010CF Wiring Diagram at the back of this manual.

### 6.5.1 Activating the outputs

The 3G4010CF/LE4010CF has four open collector outputs capable of a maximum of 50mA. Internal events on the 3G4010CF/LE4010CF can trigger the outputs to turn on an LED or activate an input on the host panel.

The default settings are as follows.

**OUTPUT 1: Landline Trouble** - Output is normally high and switches to ground when the telephone line is down.

**OUTPUT 2: Cellular Module or Network Trouble** - Output is normally high and switches to ground when the 3G4010CF/LE4010CF cannot communicate with the network.

**OUTPUT 3: Power Supply or Battery Trouble** - Output is normally high and switches to ground when a problem with the power source is detected.

**OUTPUT 4: General Module Trouble** - Output is normally low and switches to high when a Cellular Network Trouble, Power Supply/Battery Trouble, and/or a Failure to Communicate (FTC) trouble is detected.

**Note:** PGM4 must be connected to the control panel as shown in Figure 4 (Residential applications) or Figures 8-9 (Commercial applications). Program the control panel input Zone/Point as 24hr 'Supervisory' with keypad-only notification when activated. Output 4 on the 3G4010CF/LE4010CF must be set as 'Active High'.

**Note:** Once an output has been activated automatically, it will not restore until all the causes of activation are cleared.

## 6.6 Reporting codes

| 3G4010CF/LE4010CF Reporting Codes | CID      | SIA    | Programmable | Comments                          |
|-----------------------------------|----------|--------|--------------|-----------------------------------|
| Zone 1 Activation                 | E301 991 | AT 991 | YES          | AC Loss*                          |
| Zone 1 Restoral                   | R301 991 | AR 991 | YES          | AC Loss Restore *                 |
| Zone 2 Activation                 | E200 992 | FS 992 | YES          | Fire Supervisory*                 |
| Zone 2 Restoral                   | R200 992 | FV 992 | YES          | Fire Supervisory Restore*         |
| Zone 3 Activation                 | E110 993 | FA 993 | YES          | Fire *                            |
| Zone 3 Restoral                   | R110 993 | FH 993 | YES          | Fire Restore *                    |
| Zone 4 Activation                 | E300 994 | YX 994 | YES          | System Trouble *                  |
| Zone 4 Restoral                   | R300 994 | YZ 994 | YES          | System Trouble Restore *          |
| PSTN Line Down                    | E351 000 | LT 000 | FIXED        | Telco 1 Fault                     |
| PSTN Line Restoral                | R351 000 | LR 000 | FIXED        | Telco 1 Fault Restore             |
| Periodic Test                     | E603 XXX | RP XXX | FIXED        | Test Transmission <Receiver Path> |
| Periodic Test with Trouble        | E608 XXX | RY XXX | FIXED        | Test Transmission <Receiver Path> |
| Radio Activation                  | R552 000 | RS 000 | FIXED        | Remote Programming Successful     |
| Internal Buffer Full              | E624 000 | JL 000 | FIXED        |                                   |
| FTC Restoral                      | R354 000 | YK 000 | FIXED        | Communications Restored           |
| Firmware Update Successful        | R901 000 | LS 000 | FIXED        |                                   |
| Firmware Update Fail              | E902 000 | LU 000 | FIXED        |                                   |
| Firmware Update Begin             | E901 000 | LB 000 | FIXED        |                                   |
| System Tamper                     | E145 000 | ES 000 | FIXED        | Case Tamper                       |
| System Tamper Restoral            | R145 000 | EJ 000 | FIXED        | Case Tamper Restore               |

## 6.7 Swinger shutdown - only used on model LE4014CF

To prevent "runaway" signals to the central station, the 3G4010CF/LE4010CF is equipped with Swinger Shutdown which limits certain trouble events to a maximum of four reports every 24 hours. The condition restores and the counter resets at midnight. A zone input must be physically restored when swinger shutdown is cleared before the alarm restore reporting code is transmitted to the central station. Otherwise, the zone input is remains in an 'off normal' state. Swinger Shutdown applies to the following trouble conditions:

- System Tamper/Restore
- Low Battery Trouble/Restore
- TLM Trouble/Restore
- Input Power Trouble/Restore
- FTC Restore

### 6.7.1 Swinger shutdown for zone inputs (Software Version 5.12+) - only used on model LE4014CF

Depending on the reporting codes programmed by Connect 24, swinger shutdown may not be applied. Reporting codes associated with Fire, Fire Supervisory or Panic/Holdup will not have swinger shutdown applied to the Zone 1 to Zone 4 inputs when programmed.

## 6.8 Hardware default

A hardware default updates the unit with the latest configuration from C24 Communications if:

- The device was originally programmed incorrectly.
- The unit was installed at a different location and then relocated to a new site.
- A SIM card is being swapped.

To perform a hardware default, follow these steps:





1. Power down the unit (remove primary DC power and remove the backup battery) and remove all connections to Zone1, Zone 2, PGM1 and PGM.
2. Connect a wire between Z2 (terminal 14) and PGM2 (terminal 8) or Z1 (terminal 13) and PGM1 (terminal 7).
3. Power up the radio by connecting the battery first and then primary DC power.
4. Wait for 20 seconds and then completely power down the unit.
5. Disconnect the wire between the Zone and PGM terminals.

**Note:** Failure to perform hardware default will result in the unit transmitting with the previously programmed configuration.





## 6.9 Communicator reset/update

The firmware of the device can be updated over Cellular or PC-Link:

- When the firmware update begins, all LED are ON.

|  |   |  |   |
|--|---|--|---|
| <br>RED | <br>BLUE | <br>Yellow/Green<br>(Top) | <br>Yellow/Green<br>(Bottom) |
| ON   | ON  | ON   | ON  |

- During the firmware update process the LEDs are cycled individually in a chaser pattern. (different from the Advanced Carrier Selection pattern).

| <br>RED | <br>BLUE | <br>Yellow/Green<br>(Top) | <br>Yellow/Green<br>(Bottom) |
|--|---|--|---|
| FLASH ON   | OFF   | OFF  | OFF   |
| OFF  | FLASH ON  | OFF  | OFF   |
| OFF  | OFF   | FLASH ON   | OFF   |
| OFF  | OFF   | OFF  | FLASH ON  |
| FLASH ON   | OFF   | OFF  | OFF   |
| OFF  | FLASH ON  | OFF  | OFF   |
| OFF  | OFF   | FLASH ON   | OFF   |
| OFF  | OFF   | OFF  | FLASH ON  |

- After a successful update, the unit automatically restarts.

**Note:** Several resets take place during a single Firmware update session.

**Note:** The unit re-requests programming after a firmware update; the version number is updated and viewable via C24 Communications.

**Note:** Unit must not be powered down during a Firmware update.

**Note:** Unit does not process remote firmware update requests if any of the following troubles is present. If the trouble occurs after the unit has processed the firmware update request, the firmware update is not interrupted.

- Input Power Trouble
- Low Battery Trouble

## 6.10 Low power radio shutdown

When the battery voltage reaches the low battery threshold of 9.6V, the unit turns off the radio to prevent unnecessary network registrations. In this state, the unit does not communicate any events.

Radio shutdown is indicated by the LEDs as follows:

- Red LED indicates low battery trouble.
- Two green LEDs blinking on/off together indicates the radio is not ready.

This LED sequence is displayed until the low battery voltage is restored and the radio is enabled again.

## 6.11 Phone number call direction

The PTM phone numbers to receiver group 1 or 2 are programmable. The number programmed in the communicator must also be programmed as the panel phone number. When the communicator detects the phone number, it communicates to the receivers of the corresponding group.

**Note:** If no PTM phone number is programmed, all panel calls go to Receiver Group 1.

## Section 7: Troubleshooting guide

**Powering up the 3G4010CF/LE4010CF** – When powering up the 3G4010CF/LE4010CF, always connect the battery (if used) first before connecting primary DC power from the control panel or transformer.

**Wiring primary** – R-1/T-1 of 3G4010CF/LE4010CF to RING/TIP of control panel, DC power from control panel or DC transformer to DC input, backup battery.

**Wiring backup** – Incoming line to RING/TIP on 3G4010CF/LE4010CF, R-1/T-1 of 3G4010CF/LE4010CF to RING/TIP of control panel, R-1/T-1 of control panel to house phones, DC power from control panel or DC transformer to DC input, backup battery.

**Testing communications** – When the 3G4010CF/LE4010CF transmits a signal for the control panel, or for an internal transmission, the BLUE light flashes once when the signal is transmitted and twice when it receives a kiss-off.

**SIM** – The SIM should be activated at least 24 hours prior to installation. The 3G4010CF/LE4010CF will show signal strength with an inactive SIM; However, it will display the signal strength of any available wireless network. The SIM must be active to ensure the signal strength displayed is that of the wireless network provider for which the SIM belongs to.

**Panel programming** – The control panel should be programmed to communicate Contact ID or SIA exactly the same way it would be programmed to communicate Contact ID or SIA over the telephone line.

| Green/Yellow LED Status                           | What it means:             | CSQ Values                                   | Signal Strength Status   |
|---|----------------------------|--|--|
| Both Signal Strength LEDs <b>ON</b>               | Excellent Signal Strength  | 14+  | <ul style="list-style-type: none"> <li>Unit can be installed in the current mounting location.</li> </ul>  |
| Top LED <b>FLASHING</b> with bottom LED <b>ON</b> | Excellent Signal Strength  | 11-13  | <ul style="list-style-type: none"> <li>Unit can be installed in the current mounting location.</li> </ul>  |
| Bottom LED <b>ON</b>                              | Good Signal Strength       | 7-10   | <ul style="list-style-type: none"> <li>Unit can be installed in the current mounting location.</li> </ul>  |
| Bottom LED <b>FLASHING</b>                        | Poor Signal Strength       | 5-6<br>(no trouble)<br>1-4<br>(with trouble) | <ul style="list-style-type: none"> <li>Ensure the antenna cable is plugged securely into the radio connector.</li> <li>If the SIM is active, connect a battery to the unit and test various locations for good/excellent signal strength.</li> <li>Connect an antenna extension kit (LTE-8ANT, LTE-15ANT, LTE-25ANT, LTE-50ANT).</li> </ul>  |
| Both LEDs <b>OFF</b>                              | No Signal Strength         | 0  | <ul style="list-style-type: none"> <li>If the red LED is also FLASHING, refer to the RED LED chart.</li> <li>Verify SIM card is activated.</li> <li>Ensure the antenna cable is plugged securely into the radio connector.</li> <li>If the SIM is active, connect a battery to the unit and test various locations for good/excellent signal strength.</li> <li>Connect an antenna extension kit (LTE-8ANT, LTE-15ANT, LTE-25ANT, LTE-50ANT).</li> </ul> |
| Both LEDs <b>Flashing ON/OFF</b> together         | Signal Strength is invalid | N/A  | Radio is in process of network registration.   |
| Both LEDs <b>Alternating</b>                      | Radio Reset Sequence       | N/A  | Radio is performing a Reset. If the issue persists, please verify the SIM card is inserted correctly.  |

|                               |   |
|-------------------------------|---|
| Blue LED Status (Normal Mode) | What It Means: Wireless Communicator Status/Communication Indicator   |
| Blue LED ON                   | When used as a backup communicator, the blue LED will be ON when there is a no phone line connected to the 3G4010CF/LE4010CF TIP and RING, or the line voltage goes below 2.8VDC. |
| Blue LED OFF                  | A good phone line is connected to the 3G4010CF/LE4010CF. (more than 2.8 VDC detected across the 3G4010CF/LE4010CF TIP and RING terminals).  |
| Blue LED FLASHING             | The blue LED will flash one time when the 3G4010CF/LE4010CF transmits a signal and two times when a kiss-off is received.   |

| # of Flashes |       | Trouble Type                              | Trouble Notes  |
|--------------|-------|---|--|
| Red          | Blue  |   |  |
| On           | On    | No Signal Strength                        | <ul style="list-style-type: none"> <li>Verify SIM card is activated.</li> <li>Ensure the antenna cable is plugged securely into the radio connector.</li> <li>If the SIM is active, connect a battery to the unit and test various locations for good/excellent signal strength.</li> <li>Connect an antenna extension kit (LTE-8ANT, LTE-15ANT, LTE-25ANT, LTE-50ANT).</li> </ul>   |
| 1            | Off   | Wireless Network Trouble                  | <ul style="list-style-type: none"> <li>Ensure the SIM card has been activated.</li> <li>The antenna cable should be plugged securely into the radio connector.</li> <li>Ensure there is good signal strength (at least one green light ON).</li> <li>Verify the installation area is not experiencing a network outage.</li> </ul>   |
| 2            | Off   | Battery Trouble                           | <ul style="list-style-type: none"> <li>If a battery is not used in the installation, ensure that the "Internal Battery Connected" is not selected in C24 Communications.</li> <li>If a battery is used in the installation, verify the battery is connected properly</li> <li>Measure the battery under load and verify it is charged to at least 11.8VDC. If not, wait at least 1 hour for the battery to charge.</li> <li>Remove the battery and measure the voltage; the voltage should be at least 11.8VDC.</li> <li>Verify the input DC supply is rated at 13.8VDC @ 180mA minimum.</li> <li>Replace battery</li> </ul> |
| 3            | Off   | Input Power Trouble                       | <ul style="list-style-type: none"> <li>Ensure the power source connected to the 3G4010CF/LE4010CF is providing 13.8VDC @ 180mA.</li> </ul>   |
| 1            | Flash | Insufficient Signal Strength              | <ul style="list-style-type: none"> <li>Ensure the antenna cable is plugged securely into the radio connector.</li> <li>If the SIM is active, connect a battery to the unit and test various locations for good/excellent signal strength.</li> <li>Connect an antenna extension kit (LTE-8ANT, LTE-15ANT, LTE-25ANT, LTE-50ANT)</li> </ul>   |
| 2            | Flash | Not Used                                  |  |
| 3            | Flash | C24 Communications Configurations Trouble | <ul style="list-style-type: none"> <li>Ensure the SIM card is activated and correctly initialized through C24 Communications.</li> </ul>   |
| 1            | On    | Radio/SIM Trouble                         | <ul style="list-style-type: none"> <li>Ensure the SIM Card is inserted correctly and firmly.</li> <li>Ensure the antenna cable is plugged securely into the radio connector.</li> </ul>  |

|   |    |                                |   |
|---|----|--------------------------------|---|
| 2 | On | Receiver Not Available Trouble | <ul style="list-style-type: none"> <li>• Contact the monitoring station to verify that the 3G4010CF/LE4010CF programming is correct (port, IP address, DNIS).</li> <li>• Contact your central station to verify they are not experiencing any receiver issues.</li> </ul> |
| 3 | On | Supervision Trouble            | <ul style="list-style-type: none"> <li>• Contact your central station to verify they are not experiencing any receiver issues.</li> </ul>   |
| 4 | On | Tamper Trouble                 | <ul style="list-style-type: none"> <li>• Ensure the front cover is secured and the case tamper is closed.</li> </ul>  |

The Red light will flash to indicate various trouble conditions outlined previously. If multiple trouble conditions are present, the red light will flash according to the highest priority trouble. For example, if both a 3G4010CF/LE4010CF wireless network trouble (one flash) and a low battery trouble (two flashes) are present; the red light will flash one time. Once the 3G4010CF/LE4010CF wireless network trouble condition is corrected, the red light will then begin flashing two times.

| General Troubles With Your System  |   |
|--|---|
| The control panel is displaying a telephone line trouble condition                   | <ul style="list-style-type: none"> <li>• Ensure T1 and R1 of the 3G4010CF/LE4010CF are wired to the TIP and RING terminals of the control panel.</li> <li>• If the 3G4010CF/LE4010CF is being used as the primary communicator, the blue light will always be OFF.</li> <li>• If the 3G4010CF/LE4010CF red light is FLASHING, refer to the troubleshooting chart in this guide.</li> </ul>  |
| The control panel displays a communication trouble condition                         | <ul style="list-style-type: none"> <li>• Ensure the panel is programmed for Contact ID or SIA.</li> <li>• Ensure the control panel does not indicate a TLM trouble condition.</li> <li>• If the 3G4010CF/LE4010CF red light is FLASHING refer to the troubleshooting chart in this guide.</li> </ul>  |
| No signals are received at the central station but no trouble condition is displayed | <ul style="list-style-type: none"> <li>• Ensure the control panel has a central station phone number programmed.</li> <li>• Ensure the control panel has the correct account number programmed.</li> <li>• Verify the reporting codes are programmed or the auto Contact ID option is enabled.</li> <li>• Ensure the control panel communicator is enabled.</li> <li>• Connect a handset to T1 and R1 of the 3G4010CF/LE4010CF in monitor mode to verify the control panel is trying to communicate.</li> </ul> |
| Not receiving internal signals generated directly from the 3G4010CF/LE4010CF         | <ul style="list-style-type: none"> <li>• Ensure the 3G4010CF/LE4010CF was initialized with the correct account number. This can be checked by logging into the C24 Communications website.</li> <li>• Ensure that no trouble conditions are present on the 3G4010CF/LE4010CF.</li> </ul>  |
| The phone line is seized when the 3G4010CF/LE4010CF is connected                     | <ul style="list-style-type: none"> <li>• Verify correct phone line wiring.</li> <li>• Ensure the Ringer Equivalency Number (REN) is not being exceeded on the line.</li> </ul>  |

| General Information             |   |
|---------------------------------|---|
| Removing/Connecting the antenna | <ul style="list-style-type: none"> <li>• To remove the antenna from the 3G4010CF/LE4010CF, place your thumb on the end of the connector at the modem, then place a screwdriver between the modem and connector. Gently turn the screwdriver away to 'pop' out the connector from the modem.</li> <li>• To install the antenna, firmly push the connector into the modem until it 'snaps' into place.</li> </ul>   |
| Enrolling a 3G4010CF/LE4010CF   | <ul style="list-style-type: none"> <li>• The 3G4010CF/LE4010CF can be enrolled by going through the GVRU voice prompt, and completing the activation of the SIM card, and the initialization of the 3G4010CF/LE4010CF.</li> <li>• The 3G4010CF/LE4010CF can also be enrolled using the C24 Communications website (<a href="http://www.connect24.com">www.connect24.com</a>) or the C24 Communications mobile site (<a href="http://m.connect24.com">m.connect24.com</a>).</li> </ul> |



|  |   |
|--|---|
| SIM card activation period   | <ul style="list-style-type: none"> <li>• A SIM card can take up to 24 hours to be activated by the provider. However, it typically takes less than an hour for the SIM card to be activated.</li> </ul>   |
| Checking SIM status  | <ul style="list-style-type: none"> <li>• Go to <a href="http://www.connect24.com">www.connect24.com</a> and login. A search can be performed for a specific account and its current status</li> <li>• SIM status can also be checked through the GVRU.</li> </ul>   |
| Critical Shutdown on 3G4010CF/LE4010CF backup battery (with no DC input applied) | <ul style="list-style-type: none"> <li>• If the 3G4010CF/LE4010CF backup battery is used and is below 10.5VDC, the unit will go into critical shutdown.</li> <li>• The critical shutdown state will be displayed by the red light flashing followed by the blue and two green lights flashing.</li> <li>• The lights will continue to flash in this sequence until the battery is charged above 11.8VDC.</li> </ul> |
| Swinger Shutdown for 3G4010CF/LE4010CF Troubles                                  | <ul style="list-style-type: none"> <li>• Trouble events can send a maximum of 4 troubles and restorals per day.</li> <li>• Swinger Shutdown only affects signal transmissions, not the functionality of the 3G4010CF/LE4010CF lights or PGM outputs.</li> <li>• Swinger shutdown is reset at midnight or upon a full power cycle of the 3G4010CF/LE4010CF.</li> </ul>   |

Test this product at least once a year.

# Section 8: 3G4010CF/LE4010CF wiring diagrams

Figure 12-1 3G4010CF/LE4010CF wiring diagram

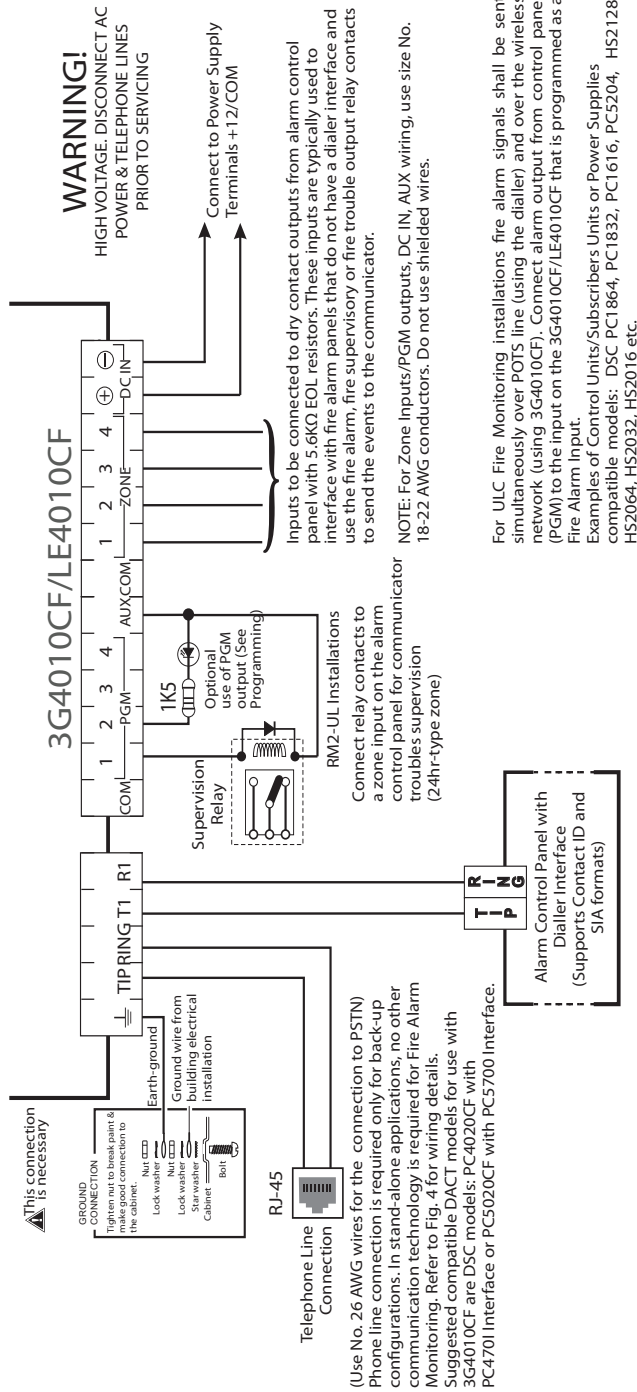

(Use No. 26 AWG wires for the connection to PSTN) Phone line connection is required only for back-up configurations. In stand-alone applications, no other communication technology is required for Fire Alarm Monitoring. Refer to Fig. 4 for wiring details. Suggested compatible DACT models for use with 3G4010CF are DSC models: PC4020CF with PC4701 Interface or PC5020CF with PC5700 Interface.

WARNING: Incorrect connections may result in PTC failure or improper operation. Inspect wiring and ensure connections are correct before turning on. All circuits are classified for UL installations as Power Limited/Class II Power Limited except for the battery leads which are not Power Limited. Do not route any wiring over circuit boards. Maintain at least 1" (25.4mm) separation. A minimum 1/4" (6.4mm) separation must be maintained at all points between Power Limited wiring and all other Non-Power Limited wiring. Route wires as indicated in the diagram.

Phone line connection is required only for back-up configurations. In stand-alone applications, no other communication technology is required for Fire Alarm Monitoring. Refer to Fig. 4 for wiring details. Suggested compatible DACT models for use with 3G4010CF/LE4010CF are DSC models: PC4020CF Interface or PC5020CF with PC5700 Interface. The 3G4010CF/LE4010CF shall be installed in accordance with the following, as applicable: NFPA 70, "National Fire Alarm Code"; NFPA 72, "National Fire Alarm Code"; National Building Code (NBC); CSA C22.1 - Canadian Electrical Code, Part 1; Section 32, CAN/ULC S561 - Standard for the Installation and Services for Fire Signal Receiving Centre and Systems; CAN/ULC-S302 - Standard for Installation and Classification of Burglar Alarm Systems for Financial and Commercial Premises, Safes and Vaults; CAN/ULC S301 - Standard for the Signal Receiving Centre Burglar Alarm Systems and Operations, Local Authorities Having Jurisdiction (AHJ) and Manufacturer's Installation Instructions.

Figure 12-2 3G4010CF/LE4010CF Module Wiring Diagram - Standalone Configuration

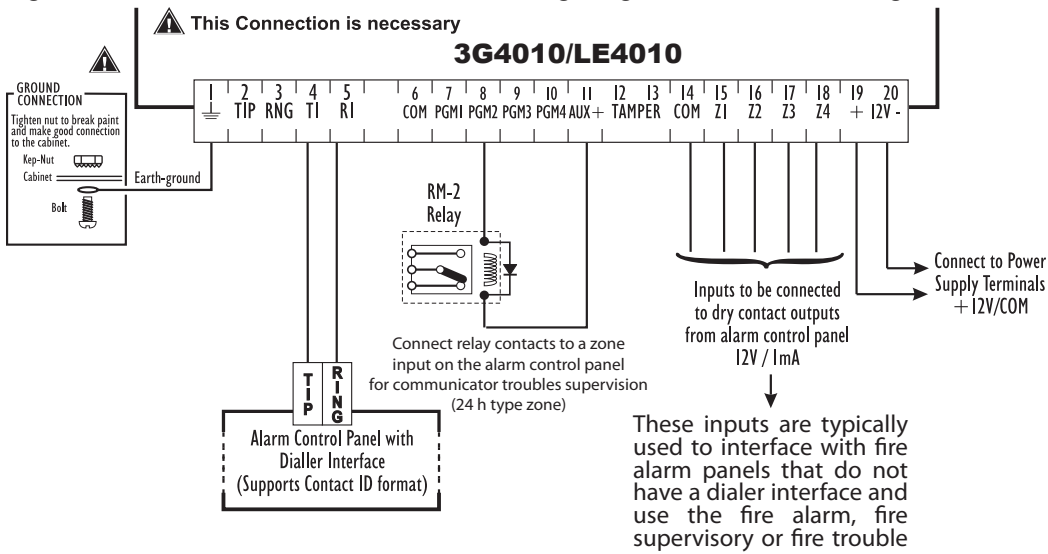

**Note:** If the control panel PGM output connected to the 3G4010CF/LE4010CF input latches (remains closed) after an alarm has occurred, the 3G4010CF/LE4010CF input will remain active. The latched PGM output must be reset or future alarms will not be reported via the zone input of the 3G4010CF/LE4010CF and additional alarms may be triggered when the 3G4010CF/LE4010CF is locally or remotely restarted. Please contact panel vendor for details on how to reset the control panel PGM.

Figure 12-3 Power Supply Wiring Diagram

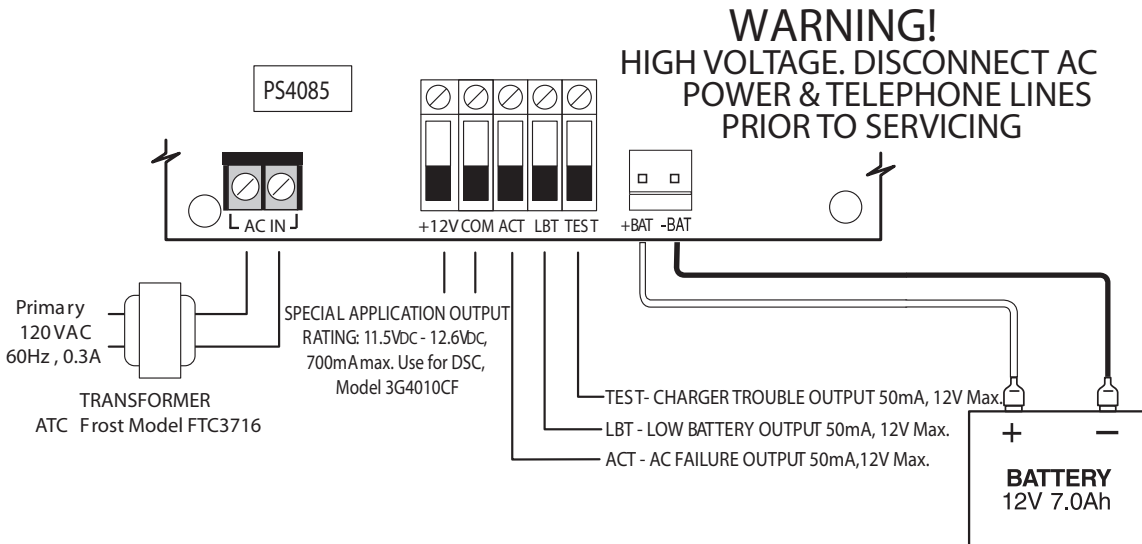

These outputs shall be connected to zone inputs of an alarm control panel in order to provide the required trouble supervision (visual and audible indication required at the control panel). The outputs are active low (switched to ground) and can be connected to a control panel directly or by using a listed supervision relay (suggested model: DSC, RM-2 or RM1C).

Figure 12-4 Telephone Connection

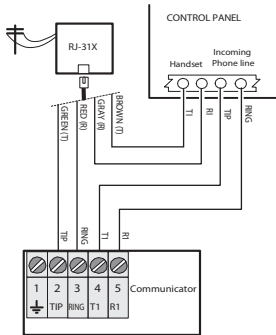
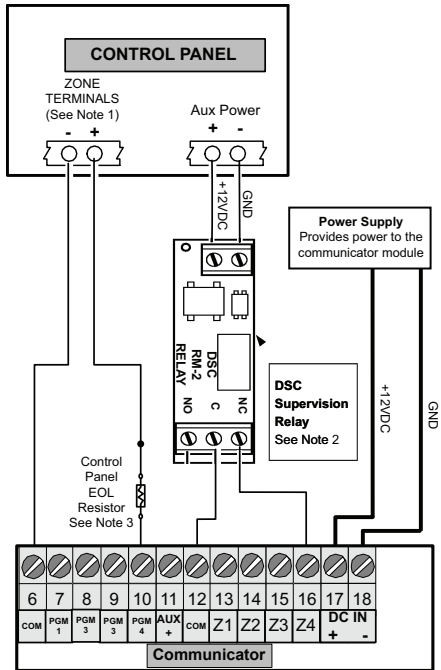

Figure 12-5 Power Supply and Supervision Wiring Diagram



**NOTES:**

1. Program the zone/point as “Supervisory” type with keypad only annunciation when in alarm. Do NOT use a zone/point that is normally used for 2-wire smoke detectors.
2. The power supervision relay (RM-2 or RM1C) is only used when the 3G4010CF/LE4010CF is not powered by the control panel. When the radio is powered by the control panel, the relay is not required since a loss of input power will generate a signal to the CMC.
3. Output 4 on the 3G4010CF/LE4010CF must be set as “Active High” (default).

## EULA

### IMPORTANT - READ CAREFULLY

DSC Software purchased with or without Products and Components is copyrighted and is purchased under the following license terms:

- This End-User License Agreement (“EULA”) is a legal agreement between You (the company, individual or entity who acquired the Software and any related Hardware) and Digital Security Controls, a division of Tyco Safety Products Canada Ltd., a part of Johnson Controls group of companies (“JCI”), the manufacturer of the integrated security systems and the developer of the software and any related products or components (“HARDWARE”) which You acquired.
- If the JCI software product (“SOFTWARE PRODUCT” or “SOFTWARE”) is intended to be accompanied by HARDWARE, and is NOT accompanied by new HARDWARE, You may not use, copy or install the SOFTWARE PRODUCT. The SOFTWARE PRODUCT includes computer software, and may include associated media, printed materials, and “online” or electronic documentation.
- Any software provided along with the SOFTWARE PRODUCT that is associated with a separate end-user license agreement is licensed to You under the terms of that license agreement.
- By installing, copying, downloading, storing, accessing or otherwise using the SOFTWARE PRODUCT, You agree unconditionally to be bound by the terms of this EULA, even if this EULA is deemed to be a modification of any previous arrangement or contract. If You do not agree to the terms of this EULA, DSC is unwilling to license the SOFTWARE PRODUCT to You, and You have no right to use it

#### SOFTWARE PRODUCT LICENSE

The SOFTWARE PRODUCT is protected by copyright laws and international copyright treaties, as well as other intellectual property laws and treaties. The SOFTWARE PRODUCT is licensed, not sold.

#### 1. GRANT OF LICENSE This EULA grants You the following rights:

**Software Installation and Use** - For each license You acquire, You may have only one copy of the SOFTWARE PRODUCT installed.

**Storage/Network Use** - The SOFTWARE PRODUCT may not be installed, accessed, displayed, run, shared or used concurrently on or from different computers, including a workstation, terminal or other digital electronic device (“Device”). In other words, if You have several workstations, You will have to acquire a license for each workstation where the SOFTWARE will be used.

**Backup Copy** - You may make back-up copies of the SOFTWARE PRODUCT, but You may only have one copy per license installed at any given time. You may use the back-up copy solely for archival purposes. Except as expressly provided in this EULA, You may not otherwise make copies of the SOFTWARE PRODUCT, including the printed materials accompanying the SOFTWARE.

#### 2. DESCRIPTION OF OTHER RIGHTS AND LIMITATIONS

**Limitations on Reverse Engineering, Decompilation and Disassembly** - You may not reverse engineer, decompile, or disassemble the SOFTWARE PRODUCT, except and only to the extent that such activity is expressly permitted by applicable law notwithstanding this limitation. You may not make any changes or modifications to the Software, without the written permission of an officer of DSC. You may not remove any proprietary notices, marks or labels from the Software Product. You shall institute reasonable measures to ensure compliance with the terms and conditions of this EULA.

**Separation of Components** - The SOFTWARE PRODUCT is licensed as a single product. Its component parts may not be separated for use on more than one HARDWARE unit.

**Single INTEGRATED PRODUCT** - If You acquired this SOFTWARE with HARDWARE, then the SOFTWARE PRODUCT is licensed with the HARDWARE as a single integrated product. In this case, the SOFTWARE PRODUCT may only be used with the HARDWARE as set forth in this EULA.

**Rental** - You may not rent, lease or lend the SOFTWARE PRODUCT. You may not make it available to others or post it on a server or web site.

**Software Product Transfer** - You may transfer all of Your rights under this EULA only as part of a permanent sale or transfer of the HARDWARE, provided You retain no copies, You transfer all of the SOFTWARE PRODUCT (including all component parts, the media and printed materials, any upgrades and this EULA), and provided the recipient agrees to the terms of this EULA. If the SOFTWARE PRODUCT is an upgrade, any transfer must also include all prior versions of the SOFTWARE PRODUCT.

**Termination** - Without prejudice to any other rights, DSC may terminate this EULA if You fail to comply with the terms and conditions of this EULA. In such event, You must destroy all copies of the SOFTWARE PRODUCT and all of its component parts.

**Trademarks** - This EULA does not grant You any rights in connection with any trademarks or service marks of DSC or its suppliers.

**3. COPYRIGHT** - All title and intellectual property rights in and to the SOFTWARE PRODUCT (including but not limited to any images, photographs, and text incorporated into the SOFTWARE PRODUCT), the accompanying printed materials, and any copies of the SOFTWARE PRODUCT, are owned by DSC or its suppliers. You may not copy the printed materials accompanying the SOFTWARE PRODUCT. All title and intellectual property rights in and to the content which may be accessed through use of the SOFTWARE PRODUCT are the property of the respective content owner and may be protected by applicable copyright or other intellectual property laws and treaties. This EULA grants You no rights to use such content. All rights not expressly granted under this EULA are reserved by DSC and its suppliers.

**4. EXPORT RESTRICTIONS** - You agree that You will not export or reexport the SOFTWARE PRODUCT to any country, person, or entity subject to Canadian export restrictions.

**5. CHOICE OF LAW** - This Software License Agreement is governed by the laws of the Province of Ontario, Canada.

**6. ARBITRATION** - All disputes arising in connection with this Agreement shall be determined by final and binding arbitration in accordance with the Arbitration Act, and the parties agree to be bound by the arbitrator’s decision. The place of arbitration shall be Toronto, Canada, and the installation manual of the arbitration shall be English.

#### 7. LIMITED WARRANTY

**NO WARRANTY** - DSC PROVIDES THE SOFTWARE “AS IS” WITHOUT WARRANTY. DSC DOES NOT WARRANT THAT THE SOFTWARE WILL MEET YOUR REQUIREMENTS OR THAT OPERATION OF THE SOFTWARE WILL BE UNINTERRUPTED OR ERROR-FREE.

**CHANGES IN OPERATING ENVIRONMENT** - DSC shall not be responsible for problems caused by changes in the operating characteristics of the HARDWARE, or for problems in the interaction of the SOFTWARE PRODUCT with non-DSC SOFTWARE or HARDWARE PRODUCTS.

**LIMITATION OF LIABILITY; WARRANTY REFLECTS ALLOCATION OF RISK** - IN ANY EVENT, IF ANY STATUTE IMPLIES WARRANTIES OR CONDITIONS NOT STATED IN THIS LICENSE AGREEMENT, DSC’S ENTIRE LIABILITY UNDER ANY PROVISION OF THIS LICENSE AGREEMENT SHALL BE LIMITED TO THE GREATER OF THE AMOUNT ACTUALLY PAID BY YOU TO LICENSE THE SOFTWARE PRODUCT AND FIVE CANADIAN DOLLARS (CAD\$5.00). BECAUSE SOME JURISDICTIONS DO NOT ALLOW THE EXCLUSION OR LIMITATION OF LIABILITY FOR CONSEQUENTIAL OR INCIDENTAL DAMAGES, THE ABOVE LIMITATION MAY NOT APPLY TO YOU.

**DISCLAIMER OF WARRANTIES** - THIS WARRANTY CONTAINS THE ENTIRE WARRANTY AND SHALL BE IN LIEU OF ANY AND ALL OTHER WARRANTIES, WHETHER EXPRESSED OR IMPLIED (INCLUDING ALL IMPLIED WARRANTIES OF MERCHANTABILITY OR FITNESS FOR A PARTICULAR PURPOSE) AND OF ALL OTHER OBLIGATIONS OR LIABILITIES ON THE PART OF DSC. DSC MAKES NO OTHER WARRANTIES. DSC NEITHER ASSUMES NOR AUTHORIZES ANY OTHER PERSON PURPORTING TO ACT ON ITS BEHALF TO MODIFY OR TO CHANGE THIS WARRANTY, NOR TO ASSUME FOR IT ANY OTHER WARRANTY OR LIABILITY CONCERNING THIS SOFTWARE PRODUCT.

**EXCLUSIVE REMEDY AND LIMITATION OF WARRANTY** - UNDER NO CIRCUMSTANCES SHALL DSC BE LIABLE FOR ANY SPECIAL, INCIDENTAL, CONSEQUENTIAL OR INDIRECT DAMAGES BASED UPON BREACH OF WARRANTY, BREACH OF CONTRACT, NEGLIGENCE, STRICT LIABILITY, OR ANY OTHER LEGAL THEORY. SUCH DAMAGES INCLUDE, BUT ARE NOT LIMITED TO, LOSS OF PROFITS, LOSS OF THE SOFTWARE PRODUCT OR ANY ASSOCIATED EQUIPMENT, COST OF CAPITAL, COST OF SUBSTITUTE OR REPLACEMENT EQUIPMENT, FACILITIES OR SERVICES, DOWN TIME, PURCHASERS TIME, THE CLAIMS OF THIRD PARTIES, INCLUDING CUSTOMERS, AND INJURY TO PROPERTY.

**WARNING:** DSC recommends that the entire system be completely tested on a regular basis. However, despite frequent testing, and due to, but not limited to, criminal tampering or electrical disruption, it is possible for this SOFTWARE PRODUCT to fail to perform as expected.

## Regulatory Information

### 8.0.1 Modification Statement

Digital Security Controls has not approved any changes or modifications to this device by the user. Any changes or modifications could void the user's authority to operate the equipment.

Digital Security Controls n'approuve aucune modification apportée à l'appareil par l'utilisateur, quelle qu'en soit la nature. Tout changement ou modification peuvent annuler le droit d'utilisation de l'appareil par l'utilisateur.

### 8.0.2 Interference Statement

This device complies with Part 15 of the FCC Rules and ISED Canada licence-exempt RSS standard(s). Operation is subject to the following two conditions: (1) this device may not cause interference, and (2) this device must accept any interference, including interference that may cause undesired operation of the device.

Le présent appareil est conforme aux CNR d'ISED Canada applicables aux appareils radio exempts de licence. L'exploitation est autorisée aux deux conditions suivantes :

(1) l'appareil ne doit pas produire de brouillage, et (2) l'utilisateur de l'appareil doit accepter tout brouillage radioélectrique subi, même si le brouillage est susceptible d'en compromettre le fonctionnement.

### 8.0.3 Wireless Notice

This equipment complies with FCC and IC radiation exposure limits set forth for an uncontrolled environment. The antenna should be installed and operated with minimum distance of 20 cm between the radiator and your body. This transmitter must not be co-located or operating in conjunction with any other antenna or transmitter.

Cet appareil est conforme aux limites d'exposition aux rayonnements de la IC pour un environnement non contrôlé. L'antenne doit être installé de façon à garder une distance minimale de 20 centimètres entre la source de rayonnements et votre corps. L'émetteur ne doit pas être colocalisé ni fonctionner conjointement avec à autre antenne ou autre émetteur.

Antenna gain must be below/Gain de l'antenne doit être ci-dessous:

| Frequency Band/Bande de fréquence | 3G4010; 3G4010CF | LE4010; LE4010CF |
|-----------------------------------|------------------|------------------|
| GSM 850 / FDD V                   | 6.21 dBi         | 6.21 dBi         |
| PCS 1900 / FDD II                 | 3.76 dBi         | 3.76 dB          |
| LTEB2                             | —                | 2.76 dBi         |
| LTEB4                             | —                | 2.82 dBi         |
| LTEB5/B12/B13                     | —                | 2.45 dBi         |

### 8.0.4 FCC Class B Digital Device Notice

This equipment has been tested and found to comply with the limits for a Class B digital device, pursuant to part 15 of the FCC Rules. These limits are designed to provide reasonable protection against harmful interference in a residential installation. This equipment generates uses and can radiate radio frequency energy and, if not installed and used in accordance with the instructions, may cause harmful interference to radio communications. However, there is no guarantee that interference will not occur in a particular installation. If this equipment does cause harmful interference to radio or television reception, which can be determined by turning the equipment off and on, the user is encouraged to try to correct the interference by one or more of the following measures:

- Reorient or relocate the receiving antenna.
- Increase the separation between the equipment and receiver.
- Connect the equipment into an outlet on a circuit different from that to which the receiver is connected.
- Consult the dealer or an experienced radio/TV technician for help.

3G4010CF:

FCC ID: F53173G4010CF

REN: 0.0A

3G4010CF Product Identifier US: F5314MO00A3G4010CF

LE4010CF:

FCC ID: F5317LE4010CF

LE4010CF Product Identifier US: F5314MO00ALE4010CF

USOC Jack: RJ-31X

**WARNING: To satisfy FCC RF exposure requirements for mobile transmitting devices, a separation distance of 20cm or more must be maintained between the antenna of this device and persons during device operation.**

### 8.0.5 Telephone Connection Requirements

A plug and jack used to connect this equipment to the premises wiring and telephone network must comply with the applicable FCC Part 68 rules and requirements adopted by the ACTA. A compliant telephone cord and modular plug is provided with this product. It is designed to be connected to a compatible modular jack that is also compliant. See installation instructions for details.

### 8.0.6 Ringer Equivalence Number (REN)

The REN is used to determine the number of devices that may be connected to a telephone line. Excessive RENs on a telephone line may result in the devices not ringing in response to an incoming call.

In most but not all areas, the sum of RENs should not exceed five (5.0). To be certain of the number of devices that may be connected to a line, as determined by the total RENs, contact the local Telephone Company. For products approved after July 23, 2001, the REN for this product is part of the product identifier that has the format. US: AAAEQ##TXXXX. The digits represented by ## are the REN without a decimal point (e.g., 03 is a REN of 0.3). For earlier products, the REN is separately shown on the label.

### 8.0.7 Incidence of Harm

If this equipment 3G4010CF/LE4010CF causes harm to the telephone network, the telephone company will notify you in advance that temporary discontinuance of service may be required. But if advance notice is not practical, the Telephone Company will notify the customer as soon as possible. Also, you will be advised of your right to file a complaint with the FCC if you believe it is necessary.

### 8.0.8 Changes in Telephone Company Equipment or Facilities

The Telephone Company may make changes in its facilities, equipment, operations or procedures that could affect the operation of the equipment. If this happens the Telephone Company will provide advance notice in order for you to make necessary modifications to maintain uninterrupted service.

### 8.0.9 Equipment Maintenance Facility

If trouble is experienced with this equipment for repair or warranty information, please contact the facility indicated below. If the equipment is causing harm to the telephone network, the Telephone Company may request that you disconnect the equipment until the problem is solved. This equipment is of a type that is not intended to be repaired by the end user.

DSC c/o APL Logistics, 2600 West Pointe Dr., Lithia Springs, GA 30122

### 8.0.10 Additional Information

Connection to party line service is subject to state tariffs. Contact the state public utility commission, public service commission or corporation commission for information. Alarm dialling equipment must be able to seize the telephone line and place a call in an emergency situation. It must be able to do this even if other equipment (telephone, answering system, computer modem, etc.) already has the telephone line in use. To do so, alarm dialling equipment must be connected to a properly installed RJ-31X jack that is electrically in series with and ahead of all other equipment attached to the same telephone line. Proper installation is depicted in the figure below. If you have any questions concerning these instructions, you should consult your telephone company or a qualified installer about installing the RJ-31X jack and alarm dialling equipment for you.

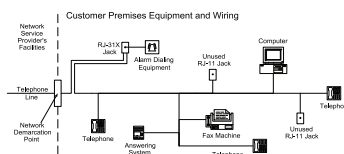

### 8.0.11 Industry Canada Compliance Statement

This Equipment meets the applicable Industrial, Scientific and Economic Development (ISED) Terminal Equipment Technical Specifications. This is confirmed by the

registration number. The abbreviation, IC, before the registration number signifies that registration was performed based on a Declaration of Conformity indicating that ISED Canada technical specifications were met. It does not imply that that ISED Canada approved the equipment. The Ringer Equivalence Number (REN) for this terminal equipment is 0.0. The REN assigned to each terminal equipment provides an indication of the maximum number of terminals allowed to be connected to a telephone interface. The termination on an interface may consist of any combination of devices subject only to the requirement that the sum of the Ringer Equivalence Numbers of all devices does not exceed 5.

IC:160A-3G4010CF

IC:160A-LE4010CF

Cet équipement est conforme aux spécifications techniques applicables aux équipements terminaux d'ISED Canada. Ceci est confirmé par le numéro d'enregistrement. L'abréviation IC précédant le numéro d'enregistrement signifie que l'enregistrement a été effectué sur la base de la Déclaration de conformité indiquant que le produit est conforme aux spécifications techniques d'ISED Canada. Ceci n'implique pas que le produit ait été approuvé par Industrie Canada.

Le nombre équivalent de sonneries (REN) de cet appareil terminal est 0.0. Le REN attribué à chaque équipement terminal fournit une indication sur le nombre maximum de terminaux pouvant être connectés sur une interface téléphonique. La terminaison sur une interface peut constituer en n'importe quelle combinaison d'appareils, à la condition seulement que la somme des Nombres équivalents de sonneries de tous les appareils ne soit pas supérieure à 5.

This Class B digital apparatus meets all requirements of the Canadian interference-causing equipment regulations. Cet appareil numérique de la Classe B respecte toutes les exigences de règlement sur le matériel brouilleur du Canada.

CAN ICES-3 (B) / NMB-3 (B)

The term "IC:" before the radio certification number only signifies that ISED Canada technical specifications were met.

NIST Validation of encryption algorithm AES128 xxxx

Warranty

Digital Security Controls ("DSC"), a division of Tyco Safety Products Canada Ltd, a part of the Johnson Controls group of companies ("JCI"), warrants the original purchaser that for a period of twelve months from the date of purchase, the product shall be free of defects in materials and workmanship under normal use. During the warranty period, JCI shall, at its option, repair or replace any defective product upon return of the product to its factory, at no charge for labour and materials. Any replacement and/or repaired parts are warranted for the remainder of the original warranty or ninety (90) days, whichever is longer. The original purchaser must promptly notify JCI in writing that there is defect in material or workmanship, such written notice to be received in all events prior to expiration of the warranty period. There is absolutely no warranty on software and all software products are sold as a user license under the terms of the software license agreement included with the product. The Customer assumes all responsibility for the proper selection, installation, operation and maintenance of any products purchased from JCI. Custom products are only warranted to the extent that they do not function upon delivery. In such cases, JCI can replace or credit at its option.

#### **International Warranty**

The warranty for international customers is the same as for any customer within Canada and the United States, with the exception that JCI shall not be responsible for any customs fees, taxes, or VAT that may be due.

#### **Warranty Procedure**

To obtain service under this warranty, please return the item(s) in question to the point of purchase. All authorized distributors and dealers have a warranty program. Anyone returning goods to JCI must first obtain an authorization number. JCI will not accept any shipment whatsoever for which prior authorization has not been obtained.

#### **Conditions to Void Warranty**

This warranty applies only to defects in parts and workmanship relating to normal use. It does not cover:

- damage incurred in shipping or handling;
- damage caused by disaster such as fire, flood, wind, earthquake or lightning;
- damage due to causes beyond the control of JCI such as excessive voltage, mechanical shock or water damage;
- damage caused by unauthorized attachment, alterations, modifications or foreign objects;
- damage caused by peripherals (unless such peripherals were supplied by JCI);
- defects caused by failure to provide a suitable installation environment for the products;
- damage caused by use of the products for purposes other than those for which it was designed;
- damage from improper maintenance;

damage arising out of any other abuse, mishandling or improper application of the products.

#### **Items Not Covered by Warranty**

In addition to the items which void the Warranty, the following items shall not be covered by Warranty: (i) freight cost to the repair center; (ii) products which are not identified with JCI's product label and lot number or serial number; (iii) products disassembled or repaired in such a manner as to adversely affect performance or prevent adequate inspection or testing to verify any warranty claim. Access cards or tags returned for replacement under warranty will be credited or replaced at JCI's option. Products not covered by this warranty, or otherwise out of warranty due to age, misuse, or damage shall be evaluated, and a repair estimate shall be provided. No repair work will be performed until a valid purchase order is received from the Customer and a Return Merchandise Authorization number (RMA) is issued by JCI's Customer Service.

JCI's liability for failure to repair the product under this warranty after a reasonable number of attempts will be limited to a replacement of the product, as the exclusive remedy for breach of warranty. Under no circumstances shall JCI be liable for any special, incidental, or consequential damages based upon breach of warranty, breach of contract, negligence, strict liability, or any other legal theory. Such damages include, but are not limited to, loss of profits, loss of the product or any associated equipment, cost of capital, cost of substitute or replacement equipment, facilities or services, down time, purchaser's time, the claims of third parties, including customers, and injury to property. The laws of some jurisdictions limit or do not allow the disclaimer of consequential damages. If the laws of such a jurisdiction apply to any claim by or against JCI, the limitations and disclaimers contained here shall be to the greatest extent permitted by law. Some states do not allow the exclusion or limitation of incidental or consequential damages, so that the above may not apply to you.

#### **Disclaimer of Warranties**

This warranty contains the entire warranty and shall be in lieu of any and all other warranties, whether expressed or implied (including all implied warranties of merchantability or fitness for a particular purpose) and of all other obligations or liabilities on the part of JCI. JCI neither assumes responsibility for, nor authorizes any other person purporting to act on its behalf to modify or to change this warranty, nor to assume for it any other warranty or liability concerning this product. This disclaimer of warranties and limited warranty are governed by the laws of the province of Ontario, Canada.

JCI recommends that the entire system be completely tested on a regular basis.

However, despite frequent testing, and due to, but not limited to, criminal tampering or electrical disruption, it is possible for this product to fail to perform as expected.

#### **Out of Warranty Repairs**

JCI will at its option repair or replace out-of-warranty products which are returned to its factory according to the following conditions. Anyone returning goods to JCI must first obtain an authorization number. JCI will not accept any shipment whatsoever for which prior authorization has not been obtained.

Products which JCI determines to be repairable will be repaired and returned. A set fee which JCI has pre-determined and which may be revised from time to time, will be charged for each unit repaired.

Products which JCI determines not to be repairable will be replaced by the nearest equivalent product available at that time. The current market price of the replacement product will be charged for each replacement unit.

#### **WARNING READ CAREFULLY**

Note to Installers

This warning contains vital information. As the only individual in contact with system users, it is your responsibility to bring each item in this warning to the attention of the users of this system.

#### **System Failures**

This system has been carefully designed to be as effective as possible. There are circumstances, however, involving fire, burglary, or other types of emergencies where it may not provide protection. Any alarm system of any type may be compromised deliberately or may fail to operate as expected for a variety of reasons. Some but not all of these reasons may be:

#### **Inadequate Installation**

A security system must be installed properly in order to provide adequate protection. Every installation should be evaluated by a security professional to ensure that all access points and areas are covered. Locks and latches on windows and doors must be secure and operate as intended. Windows, doors, walls, ceilings and other building materials must be of sufficient strength and construction to provide the level of protection expected. A reevaluation must be done during and after any construction activity. An evaluation by the fire and/or police department is highly recommended if this service is available.

Criminal Knowledge

This system contains security features which were known to be effective at the time of manufacture. It is possible for persons with criminal intent to develop techniques which reduce the effectiveness of these features. It is important that a security system be reviewed periodically to ensure that its features remain effective and that it be updated or replaced if it is found that it does not provide the protection expected.

#### Access by Intruders

Intruders may enter through an unprotected access point, circumvent a sensing device, evade detection by moving through an area of insufficient coverage, disconnect a warning device, or interfere with or prevent the proper operation of the system.

#### Power Failure

Control units, intrusion detectors, smoke detectors and many other security devices require an adequate power supply for proper operation. If a device operates from batteries, it is possible for the batteries to fail. Even if the batteries have not failed, they must be charged, in good condition and installed correctly. If a device operates only by AC power, any interruption, however brief, will render that device inoperative while it does not have power. Power interruptions of any length are often accompanied by voltage fluctuations which may damage electronic equipment such as a security system. After a power interruption has occurred, immediately conduct a complete system test to ensure that the system operates as intended.

#### Failure of Replaceable Batteries

This system's wireless transmitters have been designed to provide several years of battery life under normal conditions. The expected battery life is a function of the device environment, usage and type. Ambient conditions such as high humidity, high or low temperatures, or large temperature fluctuations may reduce the expected battery life. While each transmitting device has a low battery monitor which identifies when the batteries need to be replaced, this monitor may fail to operate as expected. Regular testing and maintenance will keep the system in good operating condition.

#### Compromise of Radio Frequency (Wireless) Devices

Signals may not reach the receiver under all circumstances which could include metal objects placed on or near the radio path or deliberate jamming or other inadvertent radio signal interference.

#### System Users

A user may not be able to operate a panic or emergency switch possibly due to permanent or temporary physical disability, inability to reach the device in time, or unfamiliarity with the correct operation. It is important that all system users be trained in the correct operation of the alarm system and that they know how to respond when the system indicates an alarm.

#### Smoke Detectors

Smoke detectors that are a part of this system may not properly alert occupants of a fire for a number of reasons, some of which follow. The smoke detectors may have been improperly installed or positioned. Smoke may not be able to reach the smoke detectors, such as when the fire is in a chimney, walls or roofs, or on the other side of closed doors. Smoke detectors may not detect smoke from fires on another level of the residence or building.

Every fire is different in the amount of smoke produced and the rate of burning. Smoke detectors cannot sense all types of fires equally well. Smoke detectors may not provide timely warning of fires caused by carelessness or safety hazards such as smoking in bed, violent explosions, escaping gas, improper storage of flammable materials, overloaded electrical circuits, children playing with matches or arson.

Even if the smoke detector operates as intended, there may be circumstances when there is insufficient warning to allow all occupants to escape in time to avoid injury or death.

#### Motion Detectors

Motion detectors can only detect motion within the designated areas as shown in their respective installation instructions. They cannot discriminate between intruders and intended occupants. Motion detectors do not provide volumetric area protection. They have multiple beams of detection and motion can only be detected in unobstructed areas covered by these beams. They cannot detect motion which occurs behind walls, ceilings, floor, closed doors, glass partitions, glass doors or windows. Any type of tampering whether intentional or unintentional such as masking, painting, or spraying of any material on the lenses, mirrors, windows or any other part of the detection system will impair its proper operation.

Passive infrared motion detectors operate by sensing changes in temperature. However, their effectiveness can be reduced when the ambient temperature rises near or above body temperature or if there are intentional or unintentional sources of heat in or near the detection area. Some of these heat sources could be heaters, radiators, stoves, barbeques, fireplaces, sunlight, steam vents, lighting and so on.

#### Warning Devices

Warning devices such as sirens, bells, horns, or strobes may not warn people or waken someone sleeping if there is an intervening wall or door. If warning devices are located on a different level of the residence or premise, then it is less likely that the occupants will be alerted or awakened. Audible warning devices may be interfered with by other

noise sources such as stereos, radios, televisions, air conditioners or other appliances, or passing traffic. Audible warning devices, however loud, may not be heard by a hearing-impaired person.

#### Telephone Lines

If telephone lines are used to transmit alarms, they may be out of service or busy for certain periods of time. Also, an intruder may cut the telephone line or defeat its operation by more sophisticated means which may be difficult to detect.

#### Insufficient Time

There may be circumstances when the system will operate as intended, yet the occupants will not be protected from the emergency due to their inability to respond to the warnings in a timely manner. If the system is monitored, the response may not occur in time to protect the occupants or their belongings.

#### Component Failure

Although every effort has been made to make this system as reliable as possible, the system may fail to function as intended due to the failure of a component.

#### Inadequate Testing

Most problems that would prevent an alarm system from operating as intended can be found by regular testing and maintenance. The complete system should be tested weekly and immediately after a break-in, an attempted break-in, a fire, a storm, an earthquake, an accident, or any kind of construction activity inside or outside the premises. The testing should include all sensing devices, keypads, consoles, alarm indicating devices and any other operational devices that are part of the system.

#### Security and Insurance

Regardless of its capabilities, an alarm system is not a substitute for property or life insurance. An alarm system also is not a substitute for property owners, renters, or other occupants to act prudently to prevent or minimize the harmful effects of an emergency situation.

© 2024 Johnson Controls. All rights reserved. Johnson Controls, Tyco and DSC are trademarks of Johnson Controls.

The trademarks, logos, and service marks displayed on this document are registered in the United States [or other countries]. Any misuse of the trademarks is strictly prohibited and Johnson Controls (JCI) will aggressively enforce its intellectual property rights to the fullest extent of the law, including pursuit of criminal prosecution wherever necessary. All trademarks not owned by JCI are the property of their respective owners, and are used with permission or allowed under applicable laws.

Product offerings and specifications are subject to change without notice. Actual products may vary from photos. Not all products include all features. Availability varies by region; contact your sales representative.

# DSC

From Tyco Security Products



29009088R005