

Installation Guide

Model TBZ48A Battery Powered Z-Wave Thermostat

This thermostat is compatible with most HVAC systems, including the following:

- 24VAC systems Note: requires both the R and C wires unless battery powered.
- Standard gas/oil/electric heating systems
 - 1 stage heating and cooling
 - 2 stage heating and cooling
- Heat Pump systems:
 - 1 stage heating and cooling
 - 2 stage heating and cooling
 - 2nd or 3rd stage Auxiliary heating (heat strips)
- Do NOT use for line voltage controls (120/240VAC)

Replacing an existing Thermostat

Stop! Before disconnecting wires from the existing thermostat, label the wires with the terminal markings from the old thermostat and record them below. Take a picture...it will be very helpful with troubleshooting or if you need to reinstall the old unit.

Read all instructions before starting installation.

Standard HVAC System Wiring

Terminal Marking	Meaning	Typical Wire Color	Record the old thermostat wire connections and terminal marking here
C	24VAC Common	Blue	
R(RH,RC)	24VAC Return	Red	
G	Fan	Green	
W or W1	Heat stage 1	White	
Y or Y1	Cool stage 1	Yellow	
W2	Heat stage 2	Orange	
Y2	Cool stage 2	Black	

Heat Pump HVAC System Wiring

Terminal Marking	Meaning	Typical Wire Color	Record the old thermostat wire connections and terminal marking here
C	24VAC Common	Blue	
R	24VAC Return	Red	
G	Fan	Green	
W or W1	Aux Heat	White	
Y or Y1	Compressor stage 1	Yellow	
O (or B*)	Change Over Valve	Orange (brown*)	
Y2	Compressor stage 2	Black	

* if you have a terminal marked "B" with a brown wire attached to it, that means you have a changeover (CO) with heating type heat pump system. Be sure to set the change over type in the **SYSTEM** menu to **CO** type: **H** (heat). Otherwise leave it set to **C** (cool).

INSTALLATION

Thermostat Power

The TBZ48 can be operated by battery power or 24VAC.

Important Note: If the thermostat is installed on a Z-Wave network while it is battery powered, it will operate as a Z-Wave FLIRS endpoint device. If it is installed on a Z-Wave network when it is 24VAC powered, it operates as an always-on Z-Wave routing device.

If the power method is changed after the thermostat is installed on a Z-Wave network, it must be uninstalled and re-installed so that the network knows what kind of powered device it is.

Battery Power

The TBZ48 can be powered by either two AA Alkaline batteries or four AA Alkaline batteries. The thermostat will operate for approximately one year on two AA Alkaline batteries depending on the frequency of user operations and backlight operation. Operation on four AA Alkaline batteries will be approximately twice as long. Always use Alkaline batteries and replace in complete sets (2 or 4) at a time with new units.

24VAC Power

The thermostat can also be powered from the HVAC system. **Both the C wire (24VAC common wire - typically blue) and the R wire (24VAC hot wire - typically red) are required for 24VAC operation.**

Note! Do not install batteries if the thermostat is powered from 24VAC. They are not required for backup.

Heating & Cooling System (HVAC) Setup

The thermostat must be setup for the correct system type and configuration of the HVAC system for proper operation.

Default HVAC System Settings

The thermostat is default setup for the following typical HVAC system configuration:

- HVAC system type: Standard gas/electric
- HVAC fan type: Gas heat
- HVAC heating stages: one
- HVAC cooling stages: one

If installed on this type of a HVAC system, the System setup does not need to change. Proceed to the wiring installation.

If installed on a Heat Pump HVAC system or any HVAC configuration other than the default settings, change the default HVAC system settings in the **SYSTEM** setup menu.

Changing the default HVAC system setup

The thermostat normally displays the Thermostat Main Control Screen. To change the thermostats HVAC system defaults, select the Menu Screen and then select the SYSTEM menu. Follow instructions below to access the SYSTEM screen.

Thermostat button operation: To conserve battery life, the thermostat backlight turns off after a short time of no activity. The **first** press of **any** button turns on the backlight (but does not initiate any action). Press the button **again** to initiate the action desired. If the backlight is already on, button presses work with the first press.

Thermostat Main Screen

The Thermostat Main Screen shows the basic thermostat settings and controls. It allows you to set the temperature setpoints and the operating modes of the HVAC system. To change the thermostat setup and other user options, first select the Thermostat Menu.

Selecting the Thermostat Menu screen

To select the Menu screen, press the FAN button once to turn ON the backlight, then press again and hold for 5 seconds

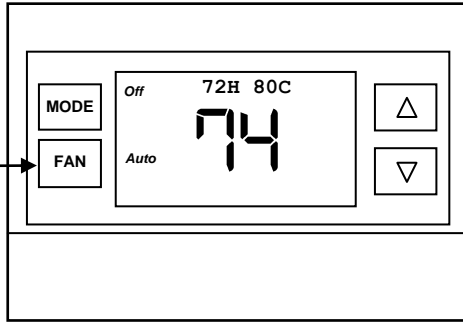

Thermostat Menu Screen

Press "Select" to enter the selected menu

Press "Done" to exit back to the Main Thermostat Screen

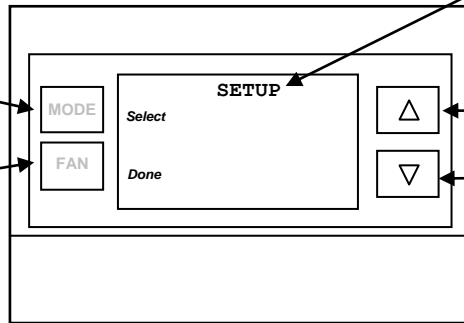

Menu choices are displayed in the Status Display Line.

Use the Up/Down buttons to change to the desired menu item, then press "Select"

Selecting the Menu Options

When the Thermostat Menu Screen is displayed, use the Up or Down arrow buttons to scroll through the following options:

- **SETUP** (user preference settings)
- **INFO** (firmware versions and Z-Wave network information)
- **CLOCK** (set the time and day)
- **ZWAVE** (install/uninstall from Z-Wave network)
- **SYSTEM** (HVAC system setup)

Changing the HVAC default settings: To change the HVAC system default settings, scroll down to the SYSTEM item and press "Select".

(See the Thermostat Operating Guide for the other menu item descriptions.)

SYSTEM Menu

The SYSTEM menu is used to setup the thermostat for the correct HVAC system type.

Settings:

- **HVAC System Type:** Standard Gas/Electric or Heat Pump
- **Fan Type:** Gas Heating or Electric Heating
- **Changeover Valve Type** (for Heat Pump Systems): Changeover with Cooling or with Heating.

When SYSTEM is selected in the Menu options, the following **setup** options will be displayed in the text line.

- Use the UP/Down arrow buttons to scroll to the desired setting.
- Press “Select” to change a setting. The current setting for that selection will be flashing.
- Change the selection with the Up/Down arrows.
- When the desired setting has been selected, Press “Select” again to save it.
- Then press “Done” to exit.

HVAC System Setup Settings

HVAC System Type (SYSTYPE):

- For Standard Gas/Electric systems, select “S”. This is the default setting.
- For Heat Pump systems, use the Up/Dn arrows to change to “HP”

Fan Type (FANTYPE): *For Standard HVAC systems only.*

Fan type depends on the heating system type.

- For Gas (**g**) heat, select “g”. This is the default setting.
- For Electric (**E**) heat : use the Up/Dn arrows to change to “E”.
- For HP systems the fan type is automatically selected, this selection is not used.

Changeover Valve Type (CO): *For Heat Pump HVAC systems only.*

The changeover (or reversing) valve is used to change from heating to cooling operation. It is either a changeover with cooling type or changeover with heating type. Most are changeover with cooling, which is the default setting.

- For Changeover with Cooling (**C**) systems, select “C”. This is the default setting.
- For Changeover with Heating (**H**) systems, use the Up/Dn arrows to change to “H”.

Not sure what type Changeover system? Check the existing thermostat connections to help determine this. If the original system had an **orange** wire connected to an “O” terminal, then this is a “**changeover with cool**” system. If there was a **brown** wire connected to a “B” terminal, then this is a “**change over with heat**” system. Set the CO setting accordingly.

Note: *If heating comes on when cooling is expected and vice versa, change the “CO” type to the opposite setting.*

Advanced System Settings Menu

The Advanced System Settings Menu provides for addition system setup options. These settings can affect system operation and should only be changed by qualified HVAC installers.

The Advanced System Settings menu is accessed by holding down the “Done” (FAN) button for 5 seconds **WHILE IN THE SYSTEM MENU**. When the Advance System

Settings menu is displayed, use the Up/Down arrow buttons to scroll to the desired setting. Press "Select" (MODE) button to change a setting. Once it begins to flash, use the Up/Down buttons to select the correct setting. Press the "Select" button to accept the new setting (flashing will stop).

Advanced Settings

Display Lock (DSPLOCK) Range: Y or N Default: N
 Y = Display LOCKED
 N = Display UNLOCKED

Allows the thermostat buttons to be locked. When the buttons are locked, none of the thermostat buttons will function. To unlock the thermostat, press and hold the FAN button for 5 seconds to access the Menu screen. Select the SYSTEM menu and return to the Advanced System Settings (as above) to turn the Display Lock off.

Auxiliary Heat (AUX HT) HP Only Range: Y or N Default: Y
 Enables the Auxiliary Heat (Stage 3 heating) operation.
 Typically the Aux Heat will be heat-strips in a Heat Pump system

2nd Stage Heat Enable (2ND HT) Range: Y or N Default: N
 Enables the 2nd Stage Heat operation

2nd Stage Cool Enable (2ND CO) Range: Y or N Default: N
 Enables the 2nd Stage Cool operation

Heat/Cool Setpoint Delta (HCDELTA) Range: 3 - 15 degrees. Default: 3F (1C)
 Sets the minimum separation between heating and cooling setpoints.

Note! Attempts to lower the cooling setpoint below the heating setpoint will PUSH the heating setpoint down to maintain this separation. The same applies to setting the heating setpoint above the cooling setpoint, it will PUSH the cooling setpoint up to maintain the setpoint delta separation.

Heating Stage 1 ON Delta (H1D ON) Range: 1 to 6 degrees Default: 1
 Sets the delta from setpoint that stage 1 heating starts.

Heating Stage 1 OFF Delta (H1D OFF) Range: 0 to 5 degrees Default: 0
 Sets the delta from setpoint that stage 1 heating stops.
 Stage 1 turns off at setpoint + Delta Stage 1.

Heating Stage 2 ON Delta (H2D ON) Range: 2 to 7 degrees Default: 2
 Sets the delta from setpoint that stage 2 heating starts.

Heating Stage 2 OFF Delta (H2D OFF) Range: 0 to 6 degrees Default: 0
 Sets the delta from setpoint that stage 2 heating stops.
 Stage 2 turns off at setpoint + Delta Stage 2.

Heating Stage 3 ON Delta (H3D ON) Range: 3 to 8 degrees Default: 3
 Sets the delta from setpoint that stage 3 heating starts.

Heating Stage 3 OFF Delta (H3D OFF) Range: 0 to 7 degrees Default: 0
 Sets the delta from setpoint that stage 3 heating stops.
 Stage 3 turns off at setpoint + Delta Stage 3.

Cooling Stage 1 ON Delta (C1D ON) Range: 1 to 7 degrees Default: 1
 Sets the delta from setpoint that stage 1 cooling starts.

Cooling Stage 1 OFF Delta (C1D OFF) Range: 0 to 6 degrees Default: 0
Sets the delta from setpoint that stage 1 cooling stops.
Stage 1 turns off at setpoint - Delta Stage 1

Cooling Stage 2 ON Delta (C2D ON) Range: 2 to 8 degrees Default: 2
Sets the delta from setpoint that stage 2 cooling starts.

Cooling Stage 2 OFF Delta (C2D OFF) Range: 0 to 7 degrees Default: 0
Sets the delta from setpoint that stage 2 cooling stops.
Stage 2 turns off at setpoint - Delta Stage 2.

Maximum Heat Setpoint (HSPMAX) Range: 55F to 96F (4C-43C) Default: 90F (32C)
Sets the maximum heating setpoint value.
Will not ramp or accept setpoints higher than this maximum.

Minimum Cool Setpoint (CSPMIN) Range: 60F to 99F (6C-45C) Default: 60F (15C)
Sets the minimum cooling setpoint value.
Will not ramp or accept setpoints lower than this minimum.

Minimum Run Time (MRT) Range: 1- 9 Minutes Default: 3
Sets the Minimum Run Time before a heating/cooling cycle can turn off.
Sets heating/cooling cycle time. Prevents rapid on/off cycling.

Minimum Off Time (MOT) Range: 5-9 Minutes Default: 5
Sets the Minimum Off Time before another heating/cooling cycle can begin. Provides compressor short cycle protection.

Heat Fan Purge (H PURGE) Range: 0-90 Seconds Default: 0
Runs the fan for this many seconds after the heat call ends. A value of 0 is OFF.

Cool Fan Purge (C PURGE) Range: 0-90 Seconds Default: 0
Runs the fan for this many seconds after the cool call ends. A value of 0 is OFF.

Status Line Display (STATUS) Range: SP (Setpoints), CL (Clock) Default: SP
Sets what is displayed on the status line of the main screen, either the Heat/Cool Setpoints or the Clock Time.

Test Mode (TEST) Range: Y or N Default: N
Y= Test mode on. Reduces all delays to 10 sec for quicker system testing
N= Test mode off. Normal system delays

CAUTION: In test mode all system safety delays are shortened. Do not operate the system compressor in test mode. Disconnect Y1 or Y2 outputs if using test mode on a live system.

Restore Defaults (RESET) Range: Yes, No Default: No
Restores all settings to factory defaults.
Press Yes to restore defaults
Press No to exit and not restore defaults

System Type (SYSTYPE) Range: S or HP Default: S
Sets the HVAC System type, StandardGas/Electric (**S**) or Heat pump (**HP**)

Fan Type (FANTYPE) Range: G or E Default: G
Sets the HVAC Fan type, Gas (**G**) heat or Electric (**E**) heat.
Only for Standard HVAC systems, no fan for gas systems, always for electric.

Changeover Type (CO)

Range: C or H

Default: C

Sets the Changeover type, Changeover with Cool (**C**) or Changeover with Heat (**H**)

Only for Heat Pump systems, Changeover valve (or reversing valve) changes the system from heating to cooling operation.

Z-Wave Installation

See the Operating Guide for instructions on installing the thermostat on a Z-Wave network.

System Settings Summary

Setting	Range	Default	
Sys Type	Std or HP	Std	
Fan Type	Gas or Elec	Gas	
C/O Type	w/Heat or w/Cool	w/Cool	
2 nd Stage Heat	Y or N	N	
Aux Heat	Y or N	Y	
2 nd Stage Cool	Y or N	N	
H/C Delta	3 – 15 deg	3	
Heat Delta Stage 1 On	1 – 6	1	
Heat Delta Stage 1 Off	0 – 5	0	
Heat Delta Stage 2 On	2 – 7	2	
Heat Delta Stage 2 Off	0 – 6	0	
Heat Delta Stage 3 On	3 – 8	3	
Heat Delta Stage 3 Off	0 – 7	0	
Cool Delta Stage 1 On	1 – 6	1	
Cool Delta Stage 1 Off	0 – 5	0	
Cool Delta Stage 2 On	2 – 7	2	
Cool Delta Stage 2 Off	0 – 6	0	
Max Heat SP	55-96F (4-42C)	90F	
Min Cool SP	60-99F (6-45C)	60F	
Min Run Time	1-9 min	3	
Min Off Time	1-9 min	5	
F/C Mode	F or C	F	
Sensor Calibration	Internal -7 to +7	0	
Backlight Timeout	10-30	20	
Restore Defaults	Yes or No	No	Exit = no
Display Lock	Y or N	N	Locks out front buttons
Test Mode	Y or N	N	Reduces delays for testing
Heat Purge	0-90 seconds	0	
Cool Purge	0-90 seconds	0	

Standard Gas/Electric HVAC System Wiring

Typical thermostat wiring colors.
Caution: verify that original wiring matches. Colors may be different.

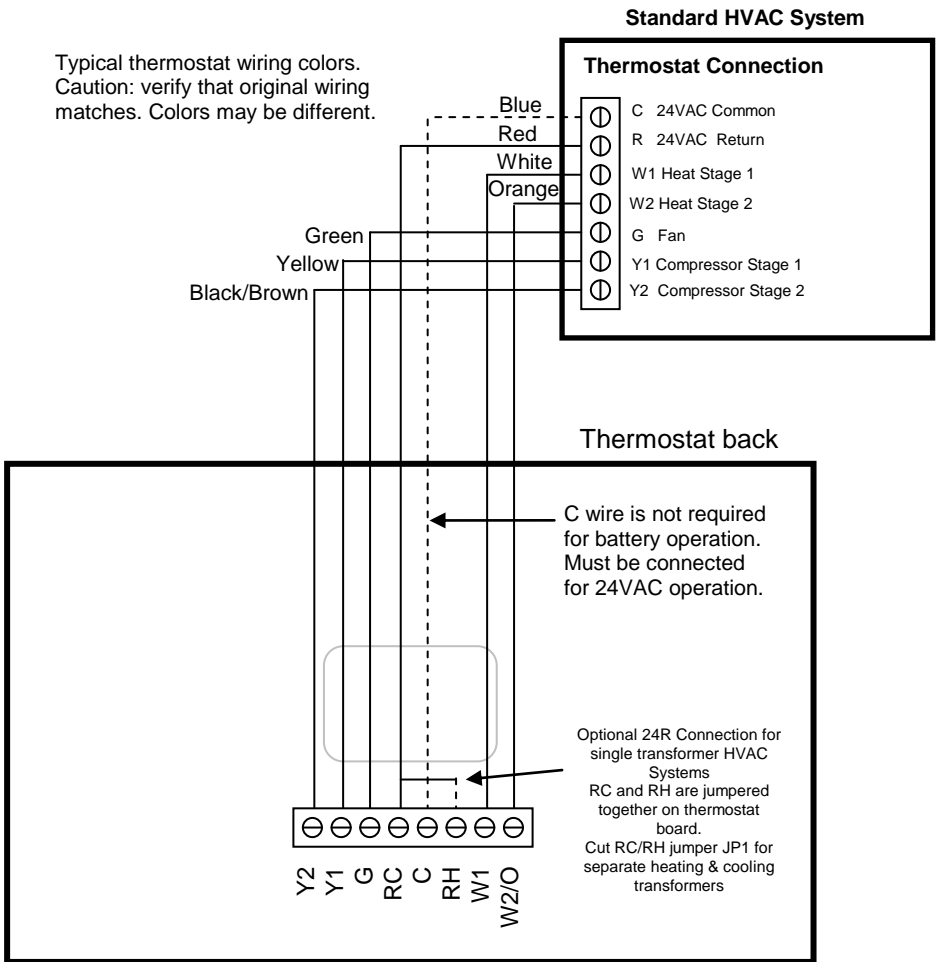

Thermostat Setup: Standard Gas/Electric HVAC Systems

To set the HVAC system type, go to the **SYSTEM** menu.

- SYSTYPE** Set the HVAC System Type: set to **S** (Standard)
- FANTYPE** Set the HVAC Fan Type:
Set to **G** (Gas) for typical gas furnace (fan is controlled by the furnace)
Set to **E** (Elec) for electric heat (fan call with heat call)
- CO** Not used for standard systems. Ignore this setting.

Go to **ADVANCED SYSTEMS SETTINGS** to set the following:

- AUX HT** Not used for standard systems. Ignore this setting
- 2ND HT** Enable second stage heating outputs
If a single stage heating system, leave this set to **N**
If a 2 stage heating system, set to **Y** to enable.
- 2ND CO** Enable second stage cooling outputs
If a single stage cooling system, leave this set to **N**.
If a two stage cooling system, set to **Y** to enable.

- Default Setup:**
- Standard HVAC
 - Fan: Gas Heat
 - 1 Stage heating
 - 1 Stage cooling

No setup required for this configuration

Heat Pump HVAC System Wiring

Heat Pump HVAC System

Typical thermostat wiring colors.
Caution: verify that original wiring matches. Colors may be different.

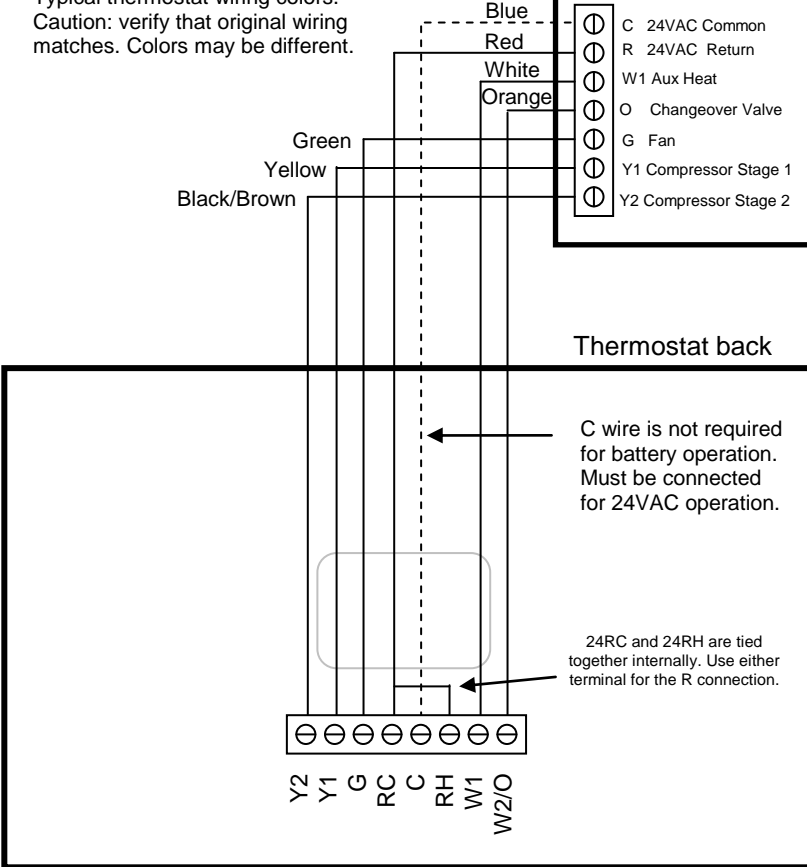

Thermostat Setup: Heat Pump HVAC Systems

To set the HVAC system type, go to the **SYSTEM** menu.

1. **SYSTYPE:** Set the HVAC System Type: set to **HP** (Heat Pump)
2. **FANTYPE:** Automatically set for heat pump systems. Ignore this setting.
3. **CO:** Changeover (reversing) Valve Type. Heat pumps change from heating to cooling by reversing operation. You must configure the thermostat's changeover valve setting to work correctly with your HVAC system. Check your system information to be sure and note the color of original thermostat wire and the terminal it was connected to. No matter what the old stat connection was (O or B), connect the wire to the thermostat's W2/O terminal. The setting of the **CO** Type will set the correct system operation. For changeover with cooling systems (Orange wire): set to **C** (cool: most common and default setting) For changeover with heating systems (Brown wire): set to **H** (heat)

- Go to **ADVANCED SYSTEMS SETTINGS** to set the following:
4. **AUXHEAT:** If you have auxiliary heat strips, set this to **Y** to enable.
 5. **2ND HT:** Enable second stage heating outputs
If a single stage heating system, leave this set to **N**
If a 2 stage heating system, set to **Y** to enable.
 6. **2ND CO:** Enable second stage cooling outputs
If a single stage cooling system, leave this set to **N**.
If a two stage cooling system, set to **Y** to enable.

Note! If you get heating when you expected cooling, change the **CO** type to the **opposite setting**.

Operation Guide

Model TBZ48A Battery Powered Z-Wave Thermostat

Main Thermostat Screen

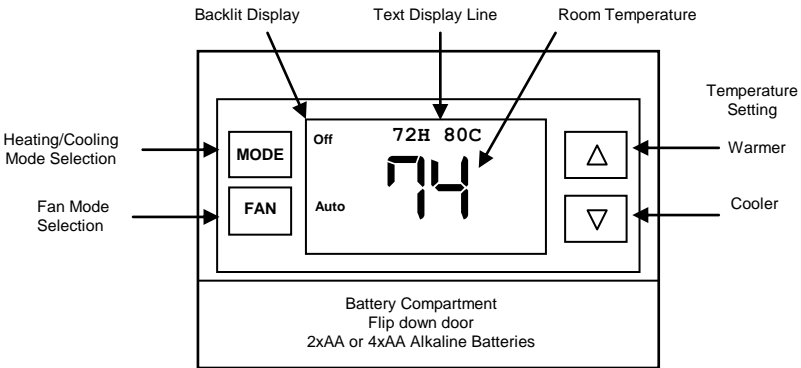

Backlight and Button Operation



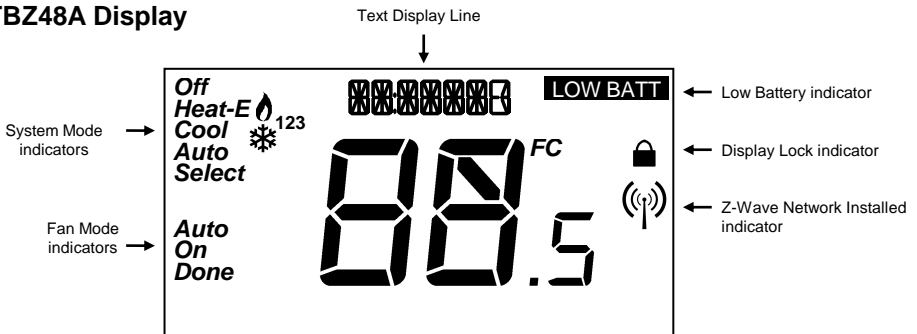

The thermostat backlight is normally set to go out after 20 seconds of no button presses to conserve battery power.

If the backlight is off, the **first** button press of **any** button will only turn on the backlight. Once the backlight is on, the buttons function normally.

TBZ48A Display



System Operation Mode

-  displayed > System is ON and heating
-  displayed > System is ON and cooling
-  blinking > System is ON and heating. Minimum Run Time (MRT) delay is active.
-  blinking > System is ON and cooling. Minimum Run Time (MRT) delay is active.

Staging Indicators

- "1" = Stage 1 heating or cooling is ON
- "2" = Stage 2 heating or cooling is ON
- "3" = Stage 3 heating (Aux Heat) is ON

For Heat Pump systems only:

"Heat-E" = Emergency heat mode active

Setting the System Mode: Off, Heat, Cool, Auto

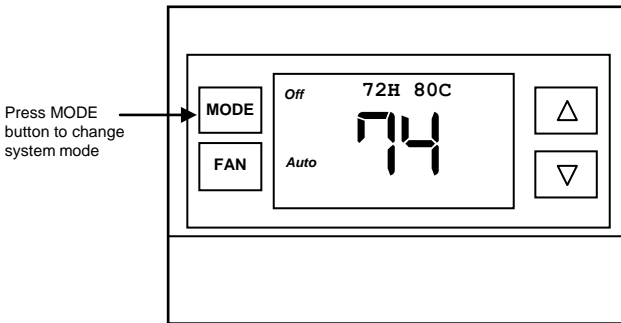

System Modes

- **Off:** System is off. No heating or cooling will come on. If system was on, it will turn off immediately.
- **Heat:** Only heating will occur.
- **Cool:** Only cooling will occur.
- **Auto:** Heating or cooling will come on according to the heating and cooling setpoints. The system will automatically switch between heating and cooling modes as needed to maintain the setpoints.

Special Heat Pump Mode: Emergency Heat

- **Heat-E:** An additional system mode, "Heat-E" for Emergency Heat will be displayed if the HVAC system type is set to Heat Pump. If there is a compressor failure with the Heat Pump system, setting the mode to EHEAT will allow the supplemental Aux heat to come on first whenever there is a call for heating. It also disables the compressor output to prevent further damage to the HVAC system.

Caution! *Emergency Heat should only be used for emergencies until the HVAC system can be repaired. Running the system in Emergency Heat mode is commonly the most expensive mode since only the electric heat strips are being used instead of the more efficient heat pump compressor.*

Setting the Heating or Cooling Temperature Setpoint

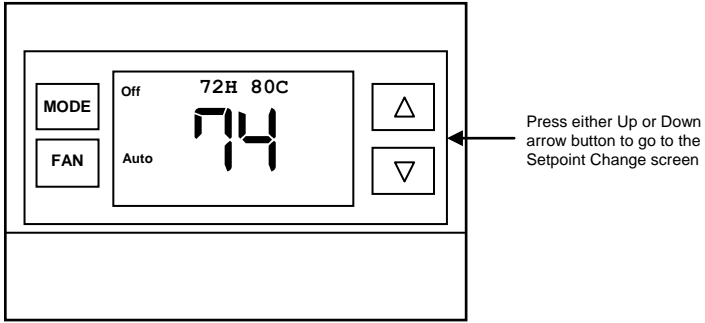

Press either Up or Down arrow button to go to the Setpoint Change screen

Setpoint Change screen

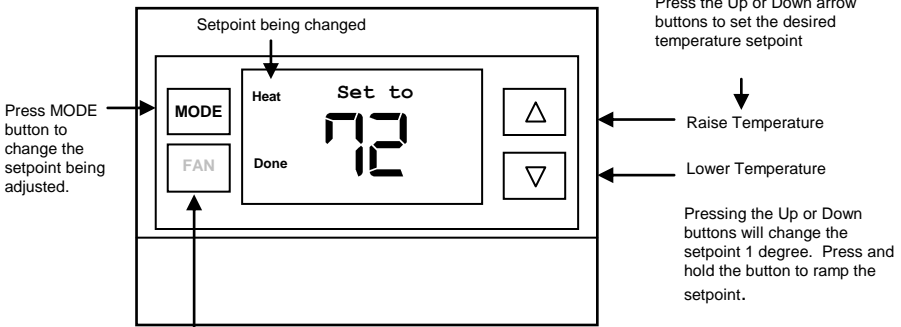

Press the Up or Down arrow buttons to set the desired temperature setpoint

Raise Temperature

Lower Temperature

Pressing the Up or Down buttons will change the setpoint 1 degree. Press and hold the button to ramp the setpoint.

Press MODE button to change the setpoint being adjusted.

Press "Done" (FAN button) to set the setpoint and exit back to the main thermostat screen or wait for the screen to automatically time out.

Setpoint Change

To change the setpoint, press the Up or Down arrow buttons. The screen will switch to the setpoint change screen (as above) and show the current setpoint of the current heating or cooling mode. Adjust setpoint temperature up or down with the arrow buttons.

! *When in the Setpoint Change screen, pressing the MODE button will switch between the Heat and Cool setpoints.*

Setpoint Push: Note that the cooling setpoint cannot be set below the heating setpoint. The thermostat will "push" the heating setpoint lower if one attempts to lower the cooling setpoint below the heating setpoint. It maintains a 3 degree separation between the heating and cooling setpoint. The same is true for raising the heating setpoint above the cooling setpoint. Again the thermostat will "push" the cooling setpoint up to maintain the 3 degree separation.

Setting the Fan Mode

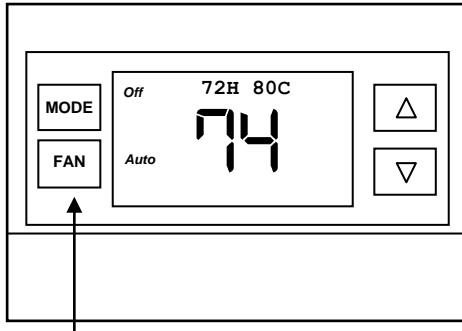

Press the FAN button to change the Fan mode

Fan Modes:

- **Auto:** Fan automatically operated by the HVAC system. (normal setting)
- **On:** Manual Fan mode. Fan stays on until mode is changed back to Auto, independent of the heating or cooling system operation.

Thermostat Menu Mode

The Thermostat has a menu of setup and information displays. Change to the Menu Mode by pressing and holding the FAN button for 5 seconds. The display will change to Menu Mode and you can scroll through the menu options with the Up/Down arrow buttons.

Thermostat Main Screen

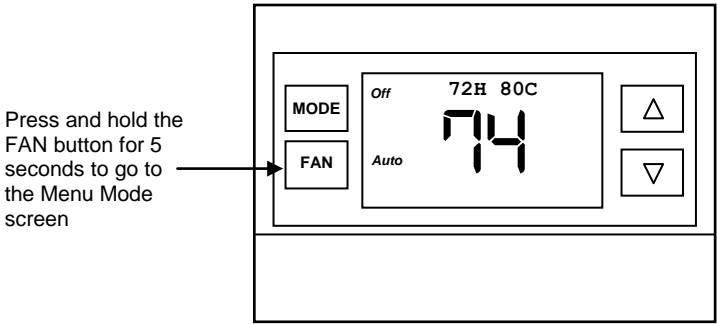

Menu Mode Screen

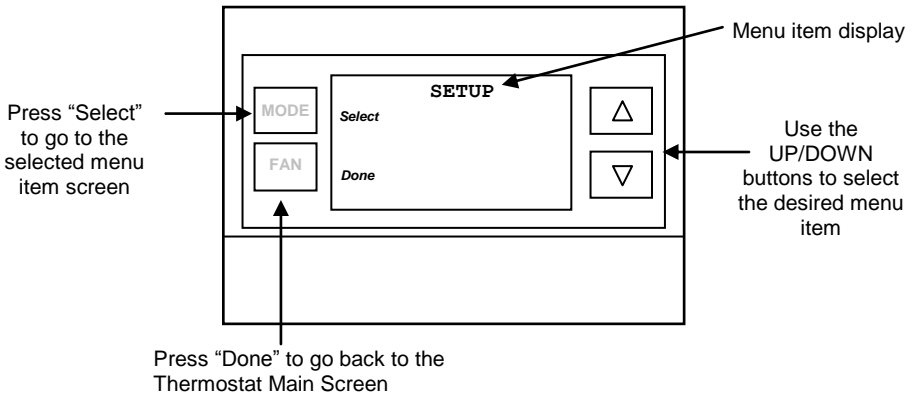

Menu Mode options

- **SETUP** User preference settings
- **INFO** Displays thermostat version and setup info
- **CLOCK** Setting the thermostat time and day
- **ZWAVE** Z-Wave network install or remove
- **SYSTEM** Thermostat HVAC system settings

SETUP Menu

User preference settings.

DEG F/C Select the temperature display mode, Fahrenheit (F) or Celsius (C).

BAKLITE Sets the time from last button press that the backlight will timeout and turn off. The backlight will turn OFF after the selected time expires. Range:10-30 seconds. Note: long backlight timeouts will reduce battery life.

SENSCAL Change the temperature calibration by +/- 7 degrees using the Up/Dn buttons.

INFO Menu

The INFO menu is used to display information about the thermostat. Use the Up/Dn buttons to scroll through the various items. Thermostat information displayed:

VERSION Thermostat firmware version

ZWAVE Z-Wave firmware version

NODE ID Z-Wave Node ID

HOME ID Z-Wave Home ID

SYSTYPE

- STANDARD (standard HVAC system)
- HP (Heat Pump HVAC system)

If HVAC type = Standard:

FAN TYPE

- GAS
- ELEC

If HVAC type = Heat Pump:

CO Changeover valve type

- CO COOL (changeover with cool)
- CO HEAT (changeover with heat)

CLOCK Menu

Set the time and day of the week.

- Time
- Day

ZWAVE Menu

This menu item allows you to install or uninstall the thermostat in the Z-Wave network. Follow the instructions in the Z-Wave Installation section.

INSTALL Install thermostat in a Z-Wave Network (when a controller is in install mode)

REMOVE Remove thermostat from a Z-Wave Network

SYSTEM Menu

SYSTYPE Select the system type, **HP** for Heat Pump, **S** for Standard (Gas/Elec)

FANTYPE Select fan type (Standard systems only), **Gas** or **Electric**

CO Select the Changeover type (HP systems only), changeover with **Heat** or **Cool**

See Installation Guide for more information on System setup and the Advanced Systems Menu

Thermostat Operation

Minimum Run Time (MRT)

The thermostat has a Minimum Run Time after the start of any heating or cooling call. This minimum run time assures even heating and cooling cycles. The MRT delay will keep the system on even if it reaches the setpoint or you change the setpoint to a temperature that would satisfy the call, until the MRT expires. Changing the Mode to OFF will cancel the MRT and the system will turn off immediately. The MRT can be adjusted in the Installer Settings menu of the thermostat.

Note: The MRT status is shown in the thermostat Status display.

Minimum Off Time (MOT)

The thermostat has a Minimum Off Time after any heating or cooling call is finished. This delay prevents rapid heating/cooling cycles and also provides "short cycle protection" for compressor calls. This delay may be noticeable when you change a setpoint and it does not respond immediately due to another call that has recently completed and the MOT delay timer is preventing the system from restarting. The MOT delay time can be adjusted in the Installer Settings menu of the thermostat. There is a minimum of 5 minutes delay to assure compressor protection.

Note: The MOT status is shown in the thermostat Status display.

Z-Wave® Operation

The TBZ48A is based on the Slave Library in the Z-Wave Ecosystem.

Z-Wave controllers from various manufacturers support the Z-Wave process of adding or removing a device from a network. The TBZ48A is a Z-Wave Slave and a Z-Wave controller is required as the primary controller to setup and maintain the network.

The following procedure will allow the TBZ48A to be installed (inclusion) or removed (exclusion) from a Z-Wave network.

NOTE: *If the TBZ48A is installed in a network while running on **batteries**, it will be installed as a FLiRs Z-Wave type of device. This is a power saving mode that conserves the batteries by keeping the radio asleep most of the time. However, in this mode, the thermostat does not act as a router node in the Z-Wave network.*

*If the TBZ48A is installed in a network while powered by **24VAC**, it will be installed as an always-listening device and can act as a router node in the Z-Wave network.*

Caution! *Once installed in a Z-Wave network, if you change how the thermostat is powered (from batteries to 24VAC or vice versa), you must remove and re-install the thermostat in the Z-Wave network for it to work correctly.*

Before installing the TBZ48A into a Z-Wave Network, check that it is not already installed in a network by viewing the Home and Zone ID's located in the **INFO** screen. An un-installed TBZ48A will show a Node ID of 0. Consult your controller's user manual for details on removing a device from a Z-Wave network.

Inclusion: Installing the TBZ48A into an existing network:

1. Set your primary controller to **Install or Include** mode, to add the TBZ48A as a node on your network (see your controller's user manual for detailed instructions).
2. Press the **FAN button** and hold until the screen changes to the Menu screen.
3. Press the **UP button** until **ZWAVE** is shown in the Status Display line then press **Select**.
4. **INSTALL** should be shown on the status line. Press **Select** to install in the network. The status line will show the progress as the TBZ48A is added into the network. Wait until **SUCCESS** or **FAILED** is shown on the status display.
5. Press **Done** to exit the ZWAVE screen.
6. Press **Done** again to exit the Menu screen.
7. The Radio Icon should be shown in the Thermostat Main screen indicating the TBZ48A is enrolled into a network.

Your controller will indicate the TBZ48A was successfully added to its network (see your controller's user manual for details). Also you can check if the TBZ48A was successfully added to the network by checking the Node ID and Home ID in the **INFO** screen.

Z-Wave Network Note: *Inclusion and exclusion are always done at normal transmit power mode.*

Network Wide Inclusion

If your controller supports Network Wide Inclusion (NWI), then you can optionally set the primary to NWI include mode. Please note that NWI inclusion mode does not end when you have included a new node. This allows multiple nodes to be included without having to physically go back to the controller to initiate the next inclusion. Therefore you must manually terminate NWI inclusion mode at the controller when you have finished including any new nodes to the network. Since intermediate included nodes will assist the inclusion process by routing messages, we recommend that nodes close to the primary controller be installed first, proceeding out in consecutive rings from the controller.

Exclusion: Removing the TBZ48A from a network:

1. Set your primary controller to **Uninstall or Remove** mode to remove the TBZ48A as a node on your network (see your controller's user manual for detailed instructions).
2. Press the **FAN** button and hold until the screen changes to the Menu screen.
3. Press the **UP** button until **ZWAVE** is shown on the status line then press **Select**.
4. **REMOVE** should be displayed. Press **Select** to remove from the network. The status display will show the progress as the TBZ48A has been removed from a network. Wait until **SUCCESS** or **FAILED** is shown on the status line.
5. The controller will indicate the TBZ48A has been removed from the network.
6. The Radio Icon will disappear from the Thermostat Main screen.

Note: You can confirm the thermostat has been removed by checking that the Node ID is 0 in the INFO screen.

INFORMATION TO USER

This device complies with Part 15 of the FCC Rules. Operation is subject to the following two conditions: (1) This device may not cause harmful interference, and (2) This device must accept any interference received, including interference that may cause undesired operation.

This equipment has been tested and found to comply with the limits for Class B Digital Device, pursuant to Part 15 of the FCC Rules. These limits are designed to provide reasonable protection against harmful interference in a residential installation. This equipment generates and can radiate radio frequency energy and, if not installed and used in accordance with the instructions, may cause harmful interference to radio communications. However, there is no guarantee that interference will not occur in a particular installation. If this equipment does cause harmful interference to radio or television reception, which can be determined by turning the equipment off and on, the user is encouraged to try to correct the interference by one or more of the following measures.

- Reorient or relocate the receiving antenna
- Increase the separation between the equipment and receiver
- Connect the equipment into an outlet on a circuit different from that to which the receiver is connected
- Consult the dealer or an experienced radio/TV technician for help

Any changes or modifications not expressly approved by the party responsible for compliance could void the user's authority to operate the equipment.

This device complies with Industry Canada license-exempt RSS standard(s). Operation is subject to the following two conditions: (1) this device may not cause interference, and (2) this device must accept any interference, including interference that may cause undesired operation of the device.

Le présent appareil est conforme aux CNR d'Industrie Canada applicables aux appareils radio exempts de licence. L'exploitation est autorisée aux deux conditions suivantes : (1) l'appareil ne doit pas produire de brouillage, et (2) l'utilisateur de l'appareil doit accepter tout brouillage radioélectrique subi, même si le brouillage est susceptible d'en compromettre le fonctionnement.