

# IMPASSA

---

## Self Contained Wireless Alarm System

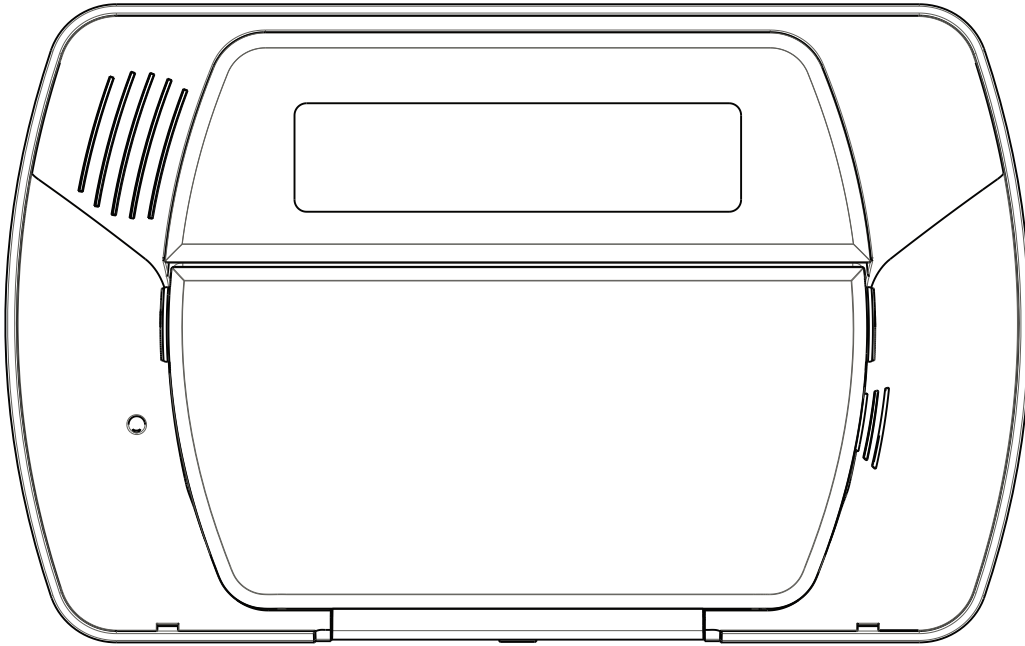

### Models:

SCW9055(D)(G)(I)-433

SCW9057(D)(G)(I)-433



v1.1 Installation Guide

---

**WARNING:** This manual contains information on limitations regarding product use and function and information on the limitations as to liability of the manufacturer. The entire manual should be carefully read.



---

# Table of Contents

<b>1 Introduction</b>	<b>1</b>
1.1 SCW9055/57 Model Differences	1
1.2 Compatible Wireless Devices	1
1.3 Product Specifications	2
1.4 Controls & Indicators	3
1.5 Data Entry	3
<b>2 Installation</b>	<b>5</b>
2.1 Mounting	5
2.2 Wiring	6
2.3 Wireless Device Setup	7
2.4 Alternate Communicator Module Setup/Initialization	9
<b>3 Operation</b>	<b>10</b>
3.1 Operating Modes	10
3.2 Language Selection	10
3.3 [*] Commands	10
3.4 Function Keys	12
3.5 System Removal Prevention	12
<b>4 Programming</b>	<b>14</b>
4.1 Template Programming	14
4.2 DLS Programming	17
4.3 Installer Programming	17
<b>5 Advanced Programming</b>	<b>18</b>
5.1 How to Program	18
5.2 Index to Programming Worksheets and Descriptions	19
5.3 Programming Worksheets	20
5.4 Programming Descriptions	42
<b>6 Testing and Troubleshooting</b>	<b>70</b>
<b>Appendix A: Reporting Code Formats</b>	<b>73</b>
<b>Appendix B: 2-Way Audio Verification (SCW9057 only)</b>	<b>77</b>
<b>Appendix C: Communicator Format Options</b>	<b>78</b>
<b>Appendix D: Regulatory Approvals Information</b>	<b>79</b>

## Safety Instructions for Service Personnel

Warning: When using equipment connected to the telephone network, always follow the basic safety instructions provided with this product. Save these instructions for future reference. Inform the end-user of the safety precautions that must be observed when operating this equipment.

### Before Installing The Equipment

Ensure your package includes the following items:

- Installation and user manuals, including the safety instructions (*Read and save these instructions!* Follow all warnings and instructions specified within this document and/or on the equipment)
- SCW905x alarm controller
- Power supply, direct plug-in
- Mounting hardware

### Selecting A Suitable Location For The Alarm Controller

Use the following list as a guide to find a suitable location to install this equipment:

- Locate near a telephone socket and power outlet.
- Select a location free from vibration and shock.
- Place the alarm controller on a flat, stable surface and follow the installation instructions.
  - Do not locate this product where people may walk on the secondary circuit cable(s).
  - Do not connect the alarm controller to electrical outlets on the same circuit as large appliances.
  - Do not select a location that exposes your alarm controller to direct sunlight, excessive heat, moisture, vapors, chemicals or dust.
  - Do not install this equipment near water. (e.g., bath tub, kitchen/laundry sink, wet basement, near a swimming pool).
  - Do not install this equipment and its accessories in areas where the risk of explosion exists.
  - Do not connect this equipment to electrical outlets controlled by wall switches or automatic timers.
  - Avoid interference sources.
  - Avoid installing the equipment near heaters, air conditioners, ventilators, and/or refrigerators.
  - Avoid locating this equipment close to or on top of large metal objects (e.g., metal wall studs).

### Safety Precautions Required During Installation

- Never install this equipment and/or telephone wiring during a lightning storm.
- Never touch uninsulated telephone wires or terminals unless the telephone line has been disconnected at the network interface.
- Position cables so that accidents can not occur. Connected cables must not be subject to excessive mechanical strain.
- Use only the power supply provided with this equipment. Use of unauthorized power supplies may cause damage.
- For direct plug-in versions, use the transformer supplied with the device.

#### WARNING:

THIS EQUIPMENT HAS NO MAINS ON/OFF SWITCH. THE PLUG OF THE DIRECT PLUG-IN POWER SUPPLY IS INTENDED TO SERVE AS THE DISCONNECTING DEVICE IF THE EQUIPMENT MUST BE QUICKLY DISCONNECTED. IT IS IMPERATIVE THAT ACCESS TO THE MAINS PLUG AND ASSOCIATED MAINS SOCKET/OUTLET IS NEVER OBSTRUCTED.

#### IMPORTANT NOTE!

This alarm system must be installed and used within an environment that provides the pollution degree max 2 and over-voltages category II NON-HAZARDOUS LOCATIONS, indoor only. The equipment is direct plug-in (external transformer) and is designed to be installed, serviced and/or repaired by service personnel only; [service person is defined as an individual having the appropriate technical training and experience to recognize hazards associated with the installation and operation of this equipment and of measures to minimize the risks to themselves and others]. This equipment contains no user-serviceable parts. The wiring (cables) used for installation of the alarm system and accessories must be insulated with PVC, TFE, PTFE, FEP, Neoprene or Polyamide.

- (a) The equipment enclosure must be secured to the building structure before operation.
- (b) Internal wiring must be routed in a manner that prevents:
  - Excessive strain or loosening of wire on terminal connections
  - Damage of conductor insulation
- (c) Disposal of used batteries must be made in accordance with local waste recovery and recycling regulations.
- (d) Before servicing, disconnect the power and telephone connection.
- (e) Do not route any wiring over circuit boards.
- (f) The installer must ensure that a readily accessible disconnect device is incorporated into the building for permanently connected installations.

The power supply must be Class II, fail safe with double or reinforced insulation between the primary and secondary circuit/enclosure and be an approved type acceptable to the local authorities. All national wiring rules must be observed.

# Guidelines for Locating Smoke & CO Detectors

The following information is for general guidance only and it is recommended that local fire codes and regulations be consulted when locating and installing smoke and CO alarms.

## Smoke Detectors

Research indicates that all hostile fires in homes generate smoke to a greater or lesser extent. Detectable quantities of smoke precede detectable levels of heat in most cases. Smoke alarms should be installed outside of each sleeping area and on each storey of the home. DSC recommends that additional smoke alarms beyond those required for minimum protection be installed. Additional areas that should be protected include: the basement; bedrooms, especially where smokers sleep; dining rooms; furnace and utility rooms; and any hallways not protected by the required units.

On smooth ceilings, detectors may be spaced 9.1m (30 feet) apart as a guide. Other spacing may be required depending on ceiling height, air movement, the presence of joists, uninsulated ceilings, etc. Consult National Fire Alarm Code NFPA 72, CAN/ULC-S553-02 or other appropriate national standards for installation recommendations.

- Do not locate smoke detectors at the top of peaked or gabled ceilings; dead air space in these locations may prevent smoke detection.
- Avoid areas with turbulent air flow, such as near doors, fans or windows. Rapid air movement around the detector may prevent smoke from entering the unit.
- Do not locate detectors in areas of high humidity.
- Do not locate detectors in areas where the temperature rises above 38°C (100°F) or falls below 5°C (41°F).

Smoke detectors should always be installed in USA in accordance with Chapter 11 of NFPA 72, the National Fire Alarm Code:

11.5.1.1. Where required by applicable laws, codes, or standards for a specific type of occupancy, approved single- and multiple-station smoke alarms shall be installed as follows:

1. In all sleeping rooms and guest rooms.
2. Outside of each separate dwelling unit sleeping area, within 6.4 m (21 ft) of any door to a sleeping room, the distance measured along a path of travel.
3. On every level of a dwelling unit, including basements.
4. On every level of a residential board and care occupancy (small facility), including basements and excluding crawl spaces and unfinished attics.
5. In the living area(s) of a guest suite.
6. In the living area(s) of a residential board and care occupancy (small facility).

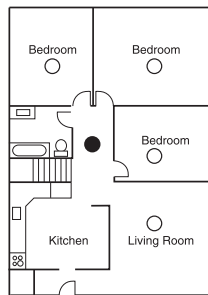

Figure 1

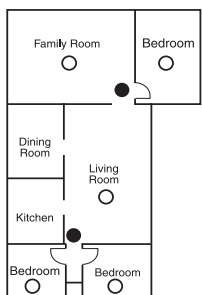

Figure 2

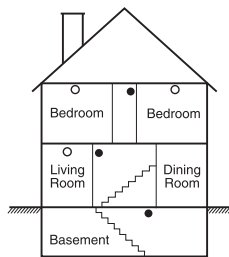

Figure 3

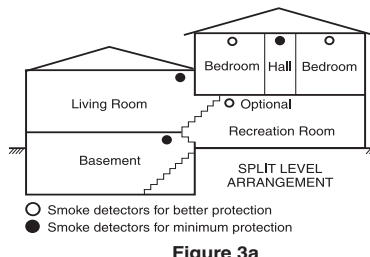

Figure 3a

- Smoke detectors for better protection
- Smoke detectors for minimum protection

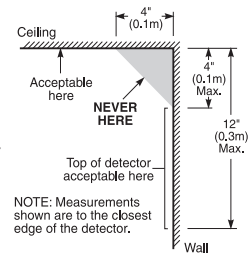

Figure 4

## CO Detectors

CO gas moves freely in the air. The human body is most vulnerable to the effects of CO gas during sleeping hours. For maximum protection, a CO alarm should be located outside primary sleeping areas or on each level of your home. Figure 5 indicates the suggested locations in the home. The electronic sensor detects carbon monoxide, measures the concentration and sounds a loud alarm before a potentially harmful level is reached.

Do NOT place the CO alarm in the following areas:

- Where the temperature may drop below -10°C or exceed 40 °C.
- Near paint thinner fumes.
- Within 5 feet (1.5 meters) of open flame appliances such as furnaces, stoves and fireplaces.
- In exhaust streams from gas engines, vents, flues or chimneys.
- Do not place in close proximity to an automobile exhaust pipe; this will damage the detector.

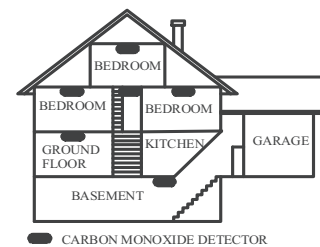

Figure 5

## Limited Warranty

Digital Security Controls warrants the original purchaser that for a period of twelve months from the date of purchase, the product shall be free of defects in materials and workmanship under normal use. During the warranty period, Digital Security Controls shall, at its option, repair or replace any defective product upon return of the product to its factory, at no charge for labour and materials. Any replacement and/or repaired parts are warranted for the remainder of the original warranty or ninety (90) days, whichever is longer. The original purchaser must promptly notify Digital Security Controls in writing that there is a defect in material or workmanship, such written notice to be received in all events prior to expiration of the warranty period. There is absolutely no warranty on software and all software products are sold as a user license under the terms of the software license agreement included with the product. The Customer assumes all responsibility for the proper selection, installation, operation and maintenance of any products purchased from DSC. Custom products are only warranted to the extent that they do not function upon delivery. In such cases, DSC can replace or credit at its option.

### International Warranty

The warranty for international customers is the same as for any customer within Canada and the United States, with the exception that Digital Security Controls shall not be responsible for any customs fees, taxes, or VAT that may be due.

### Warranty Procedure

To obtain service under this warranty, please return the item(s) in question to the point of purchase. All authorized distributors and dealers have a warranty program. Anyone returning goods to Digital Security Controls must first obtain an authorization number. Digital Security Controls will not accept any shipment whatsoever for which prior authorization has not been obtained.

### Conditions to Void Warranty

This warranty applies only to defects in parts and workmanship relating to normal use. It does not cover:

- damage incurred in shipping or handling;
- damage caused by disaster such as fire, flood, wind, earthquake or lightning;
- damage due to causes beyond the control of Digital Security Controls such as excessive voltage, mechanical shock or water damage;
- damage caused by unauthorised attachment, alterations, modifications or foreign objects;
- damage caused by peripherals (unless such peripherals were supplied by Digital Security Controls Ltd.);
- defects caused by failure to provide a suitable installation environment for the products;
- damage caused by use of the products for purposes other than those for which it was designed;
- damage from improper maintenance;
- damage arising out of any other abuse, mishandling or improper application of the products.

### Note to Installers

This warning contains vital information. As the only individual in contact with system users, it is your responsibility to bring each item in this warning to the attention of the users of this system.

### System Failures

This system has been carefully designed to be as effective as possible. There are circumstances, however, involving fire, burglary, or other types of emergencies where it may not provide protection. Any alarm system of any type may be compromised deliberately or may fail to operate as expected for a variety of reasons. Some but not all of these reasons may be:

#### • Inadequate Installation

A security system must be installed properly in order to provide adequate protection. Every installation should be evaluated by a security professional to ensure that all access points and areas are covered. Locks and latches on windows and doors must be secure and operate as intended. Windows, doors, walls, ceilings and other building materials must be of sufficient strength and construction to provide the level of protection expected. A reevaluation must be done during and after any construction activity. An evaluation by the fire and/or police department is highly recommended if this service is available.

#### • Criminal Knowledge

This system contains security features which were known to be effective at the time of manufacture. It is possible for persons with criminal intent to develop techniques which reduce the effectiveness of these features. It is important that a security system be reviewed periodically to ensure that its features remain effective and that it be updated or replaced if it is found that it does not provide the protection expected.

#### • Access by Intruders

Intruders may enter through an unprotected access point, circumvent a sensing device, evade detection by moving through an area of insufficient coverage, disconnect a warning device, or interfere with or prevent the proper operation of the system.

#### • Power Failure

Control units, intrusion detectors, smoke detectors and many other security devices require an adequate power supply for proper operation. If a device operates from batteries, it is possible for the batteries to fail. Even if the batteries have not failed, they must be charged, in good condition and installed correctly. If a device operates only by AC power, any interruption, however brief, will render that device inoperative while it does not have power. Power interruptions of any length are often accompanied by voltage fluctuations which may damage electronic equipment such as a security system. After a power interruption has occurred, immediately conduct a complete system test to ensure that the system operates as intended.

#### • Failure of Replaceable Batteries

This system's wireless transmitters have been designed to provide several years of battery life under normal conditions. The expected battery life is a function of the device environment, usage and type. Ambient conditions such as high humidity, high or low temperatures, or large temperature fluctuations may reduce the expected battery life. While each transmitting device has a low battery monitor which identifies when the batteries need to be replaced, this monitor may fail to operate as expected. Regular testing and maintenance will keep the system in good operating condition.

#### • Compromise of Radio Frequency (Wireless) Devices

Signals may not reach the receiver under all circumstances which could include metal objects placed on or near the radio path or deliberate jamming or other inadvertent radio signal interference.

#### • System Users

A user may not be able to operate a panic or emergency switch possibly due to permanent or temporary physical disability, inability to reach the device in time, or unfamiliarity with the correct operation. It is important that all system users be trained in the correct operation of the alarm system and that they know how to respond when the system indicates an alarm.

#### • Smoke Detectors

Smoke detectors that are a part of this system may not properly alert occupants of a fire for a number of reasons, some of which follow. The smoke

**IMPORTANT - READ CAREFULLY: DSC Software purchased with or without Products and Components is copyrighted and is purchased under the following license terms:**

- This End-User License Agreement ("EULA") is a legal agreement between You (the company, individual or entity who acquired the Software and any related Hardware) and Digital Security Controls, a division of Tyco Safety Products Canada Ltd. ("DSC"), the manufacturer of the integrated security systems and the developer of the software and any related products or components ("HARDWARE") which you acquired.
- If the DSC software product ("SOFTWARE PRODUCT" or "SOFTWARE") is intended to be accompanied by HARDWARE, and is NOT accompanied by new HARDWARE, You may not use, copy or install the SOFTWARE PRODUCT. The SOFTWARE PRODUCT includes computer software, and may include associated media, printed materials, and "online" or electronic documentation.
- Any software provided along with the SOFTWARE PRODUCT that is associated with a separate end-user license agreement is licensed to You under the terms of that license agreement.
- By installing, copying, downloading, storing, accessing or otherwise using the SOFTWARE PRODUCT, you agree unconsciously to be bound by the terms of this EULA, even if this EULA is deemed to be a modification of any previous arrangement or contract. If You do not agree to the terms of this EULA, DSC is unwilling to license the SOFTWARE PRODUCT to You, and You have no right to use it.

### SOFTWARE PRODUCT LICENSE

The SOFTWARE PRODUCT is protected by copyright laws and international copyright treaties, as well as other intellectual property laws and treaties. The SOFTWARE PRODUCT is licensed, not sold.

#### 1. GRANT OF LICENSE This EULA grants You the following rights:

- (a) Software Installation and Use - For each license You acquire, You may have only one copy of the SOFTWARE PRODUCT installed.
- (b) Storage/Network Use - The SOFTWARE PRODUCT may not be installed, accessed, displayed, run, shared or used concurrently on or from different computers, including a workstation, terminal or other digital electronic device ("Device"). In other words, if You have several workstations, You will have to acquire a license for each workstation where the SOFTWARE will be used.
- (c) Backup Copy - You may make back-up copies of the SOFTWARE PRODUCT, but You may only have one copy per license installed at any given time. You may use the back-up copy solely for archival purposes. Except as expressly provided in this EULA, You may not otherwise make copies of the SOFTWARE PRODUCT, including the printed materials accompanying the SOFTWARE.

#### 2. DESCRIPTION OF OTHER RIGHTS AND LIMITATIONS

- (a) Limitations on Reverse Engineering, Decompilation and Disassembly - You may not reverse engineer, decompile, or disassemble the SOFTWARE PRODUCT, except and only to the extent that such activity is expressly permitted by applicable law notwithstanding this limitation. You may not make any changes or modifications to the Software, without the written permission of an officer of DSC. You may not remove any proprietary notices, marks or labels from the Software Product. You shall institute reasonable measures to ensure compliance with the terms and conditions of this EULA.
- (b) Separation of Components - The SOFTWARE PRODUCT is licensed as a single product. Its component parts may not be separated for use on more than one HARDWARE unit.
- (c) Single INTEGRATED PRODUCT - If You acquired this SOFTWARE with HARDWARE, then the SOFTWARE PRODUCT is licensed with the HARDWARE as a single integrated product. In this case, the SOFTWARE PRODUCT may only be used with the HARDWARE as set forth in this EULA.
- (d) Rental - You may not rent, lease or lend the SOFTWARE PRODUCT. You may not make it available to others or post it on a server or web site.
- (e) Software Product Transfer - You may transfer all of Your rights under this EULA only as part of a permanent sale or transfer of the HARDWARE, provided You retain no copies, You transfer all of the SOFTWARE PRODUCT (including all component parts, the media and printed materials, any upgrades and this EULA), and provided the recipient agrees to the terms of this EULA. If the SOFTWARE PRODUCT is an upgrade, any transfer must also include all prior versions of the SOFTWARE PRODUCT.

### Items Not Covered by Warranty

In addition to the items which void the Warranty, the following items shall not be covered by Warranty: (i) freight cost to the repair centre; (ii) products which are not identified with DSC's product label and lot number or serial number; (iii) products disassembled or repaired in such a manner as to adversely affect performance or prevent adequate inspection or testing to verify any warranty claim. Access cards or tags returned for replacement under warranty will be credited or replaced at DSC's option. Products not covered by this warranty, or otherwise out of warranty due to age, misuse, or damage shall be evaluated, and a repair estimate shall be provided. No repair work will be performed until a valid purchase order is received from the Customer and a Return Merchandise Authorization number (RMA) is issued by DSC's Customer Service.

Digital Security Controls Ltd.'s liability for failure to repair the product under this warranty after a reasonable number of attempts will be limited to a replacement of the product, as the exclusive remedy for breach of warranty. Under no circumstances shall Digital Security Controls be liable for any special, incidental, or consequential damages based upon breach of warranty, breach of contract, negligence, strict liability, or any other legal theory. Such damages include, but are not limited to, loss of profits, loss of the product or any associated equipment, cost of capital, cost of substitute or replacement equipment, facilities or services, down time, purchaser's time, the claims of third parties, including customers, and injury to property. The laws of some jurisdictions limit or do not allow the disclaimer of consequential damages. If the laws of such a jurisdiction apply to any claim by or against DSC, the limitations and disclaimers contained here shall be to the greatest extent permitted by law. Some states do not allow the exclusion or limitation of incidental or consequential damages, so that the above may not apply to you.

### Disclaimer of Warranties

This warranty contains the entire warranty and shall be in lieu of any and all other warranties, whether expressed or implied (including all implied warranties of merchantability or fitness for a particular purpose) and of all other obligations or liabilities on the part of Digital Security Controls. Digital Security Controls neither assumes responsibility for, nor authorizes any other person purporting to act on its behalf to modify or to change this warranty, nor to assume for it any other warranty or liability concerning this product. This disclaimer of warranties and limited warranty are governed by the laws of the province of Ontario, Canada.

**WARNING: Digital Security Controls recommends that the entire system be completely tested on a regular basis. However, despite frequent testing, and due to, but not limited to, criminal tampering or electrical disruption, it is possible for this product to fail to perform as expected.**

### Out of Warranty Repairs

Digital Security Controls will at its option repair or replace out-of-warranty products which are returned to its factory according to the following conditions. Anyone returning goods to Digital Security Controls must first obtain an authorization number. Digital Security Controls will not accept any shipment whatsoever for which prior authorization has not been obtained.

Products which Digital Security Controls determines to be repairable will be repaired and returned. A set fee which Digital Security Controls has predetermined and which may be revised from time to time, will be charged for each unit repaired.

Products which Digital Security Controls determines not to be repairable will be replaced by the nearest equivalent product available at that time. The current market price of the replacement product will be charged for each replacement unit.

## WARNING - READ CAREFULLY

detectors may have been improperly installed or positioned. Smoke may not be able to reach the smoke detectors, such as when the fire is in a chimney, walls or roofs, or on the other side of closed doors. Smoke detectors may not detect smoke from fires on another level of the residence or building. Every fire is different in the amount of smoke produced and the rate of burning. Smoke detectors cannot sense all types of fires equally well. Smoke detectors may not provide timely warning of fires caused by carelessness or safety hazards such as smoking in bed, violent explosions, escaping gas, improper storage of flammable materials, overloaded electrical circuits, children playing with matches or arson.

Even if the smoke detector operates as intended, there may be circumstances when there is insufficient warning to allow all occupants to escape in time to avoid injury or death.

#### • Motion Detectors

Motion detectors can only detect motion within the designated areas as shown in their respective installation instructions. They cannot discriminate between intruders and intended occupants. Motion detectors do not provide volumetric area protection. They have multiple beams of detection and motion can only be detected in unobstructed areas covered by these beams. They cannot detect motion which occurs behind walls, ceilings, floor, closed doors, glass partitions, glass doors or windows. Any type of tampering whether intentional or unintentional such as masking, painting, or spraying of any material on the lenses, mirrors, windows or any other part of the detection system will impair its proper operation.

Passive infrared motion detectors operate by sensing changes in temperature. However their effectiveness can be reduced when the ambient temperature rises near or above body temperature or if there are intentional or unintentional sources of heat in or near the detection area. Some of these heat sources could be heaters, radiators, stoves, barbecues, fireplaces, sunlight, steam vents, lighting and so on.

#### • Warning Devices

Warning devices such as sirens, bells, horns, or strobes may not warn people or waken someone sleeping if there is an intervening wall or door. If warning devices are located on a different level of the residence or premise, then it is less likely that the occupants will be alerted or awakened. Audible warning devices may be interfered with by other noise sources such as stereos, radios, televisions, air conditioners or other appliances, or passing traffic. Audible warning devices, however loud, may not be heard by a hearing-impaired person.

#### • Telephone Lines

If telephone lines are used to transmit alarms, they may be out of service or busy for certain periods of time. Also an intruder may cut the telephone line or defeat its operation by more sophisticated means which may be difficult to detect.

#### • Insufficient Time

There may be circumstances when the system will operate as intended, yet the occupants will not be protected from the emergency due to their inability to respond to the warnings in a timely manner. If the system is monitored, the response may not occur in time to protect the occupants or their belongings.

#### • Component Failure

Although every effort has been made to make this system as reliable as possible, the system may fail to function as intended due to the failure of a component.

#### • Inadequate Testing

Most problems that would prevent an alarm system from operating as intended can be found by regular testing and maintenance. The complete system should be tested weekly and immediately after a break-in, an attempted break-in, a fire, a storm, an earthquake, an accident, or any kind of construction activity inside or outside the premises. The testing should include all sensing devices, keypads, consoles, alarm indicating devices and any other operational devices that are part of the system.

#### • Security and Insurance

Regardless of its capabilities, an alarm system is not a substitute for property or life insurance. An alarm system also is not a substitute for property owners, renters, or other occupants to act prudently to prevent or minimize the harmful effects of an emergency situation.

**IMPORTANT - READ CAREFULLY: DSC Software purchased with or without Products and Components is copyrighted and is purchased under the following license terms:**

- (f) Termination - Without prejudice to any other rights, DSC may terminate this EULA if You fail to comply with the terms and conditions of this EULA. In such event, You must destroy all copies of the SOFTWARE PRODUCT and all of its component parts.
- (g) Trademarks - This EULA does not grant You any rights in connection with any trademarks or service marks of DSC or its suppliers.
3. COPYRIGHT - All title and intellectual property rights in and to the SOFTWARE PRODUCT (including but not limited to any images, photographs, and text incorporated into the SOFTWARE PRODUCT), the accompanying printed materials, and any copies of the SOFTWARE PRODUCT, are owned by DSC or its suppliers. You may not copy the printed materials accompanying the SOFTWARE PRODUCT. All title and intellectual property rights in and to the content which may be accessed through use of the SOFTWARE PRODUCT are the property of the respective content owner and may be protected by applicable copyright or other intellectual property laws and treaties. This EULA grants You no rights to use such content. All rights not expressly granted under this EULA are reserved by DSC and its suppliers.
4. EXPORT RESTRICTIONS - You agree that You will not export or re-export the SOFTWARE PRODUCT to any country, person, or entity subject to Canadian export restrictions.
5. CHOICE OF LAW - This Software License Agreement is governed by the laws of the Province of Ontario, Canada.
6. ARBITRATION - All disputes arising in connection with this Agreement shall be determined by final and binding arbitration in accordance with the Arbitration Act, and the parties agree to be bound by the arbitrator's decision. The place of arbitration shall be Toronto, Canada, and the installation manual of the arbitration shall be English.
7. LIMITED WARRANTY
- (a) NO WARRANTY - DSC PROVIDES THE SOFTWARE "AS IS" WITHOUT WARRANTY. DSC DOES NOT WARRANT THAT THE SOFTWARE WILL MEET YOUR REQUIREMENTS OR THAT OPERATION OF THE SOFTWARE WILL BE UNINTERRUPTED OR ERROR-FREE.
- (b) CHANGES IN OPERATING ENVIRONMENT - DSC shall not be responsible for problems caused by changes in the operating characteristics of the HARDWARE, or for problems in the interaction of the SOFTWARE PRODUCT with non-DSC-SOFTWARE or HARDWARE PRODUCTS.
- (c) LIMITATION OF LIABILITY; WARRANTY REFLECTS ALLOCATION OF RISK - IN ANY EVENT, IF ANY STATUTE IMPLIES WARRANTIES OR CONDITIONS NOT STATED IN THIS LICENSE AGREEMENT, DSC'S ENTIRE LIABILITY UNDER ANY PROVISION OF THIS LICENSE AGREEMENT SHALL BE LIMITED TO THE GREATER OF THE AMOUNT ACTUALLY PAID BY YOU TO LICENSE THE SOFTWARE PRODUCT AND FIVE CANADIAN DOLLARS (CAD\$5.00). BECAUSE SOME JURISDICTIONS DO NOT ALLOW THE EXCLUSION OR LIMITATION OF LIABILITY FOR CONSEQUENTIAL OR INCIDENTAL DAMAGES, THE ABOVE LIMITATION MAY NOT APPLY TO YOU.
- (d) DISCLAIMER OF WARRANTIES - THIS WARRANTY CONTAINS THE ENTIRE WARRANTY AND SHALL BE IN LIEU OF ANY AND ALL OTHER WARRANTIES, WHETHER EXPRESSED OR IMPLIED (INCLUDING ALL IMPLIED WARRANTIES OF MERCHANTABILITY OR FITNESS FOR A PARTICULAR PURPOSE) AND OF ALL OTHER OBLIGATIONS OR LIABILITIES ON THE PART OF DSC. DSC MAKES NO OTHER WARRANTIES. DSC NEITHER ASSUMES NOR AUTHORIZES ANY OTHER PERSON PURPORTING TO ACT ON ITS BEHALF TO MODIFY OR TO CHANGE THIS WARRANTY, NOR TO ASSUME FOR IT ANY OTHER WARRANTY OR LIABILITY CONCERNING THIS SOFTWARE PRODUCT.
- (e) EXCLUSIVE REMEDY AND LIMITATION OF WARRANTY - UNDER NO CIRCUMSTANCES SHALL DSC BE LIABLE FOR ANY SPECIAL, INCIDENTAL, CONSEQUENTIAL OR INDIRECT DAMAGES BASED UPON BREACH OF WARRANTY, BREACH OF CONTRACT, NEGLIGENCE, STRICT LIABILITY, OR ANY OTHER LEGAL THEORY. SUCH DAMAGES INCLUDE, BUT ARE NOT LIMITED TO, LOSS OF PROFITS, LOSS OF THE SOFTWARE PRODUCT OR ANY ASSOCIATED EQUIPMENT, COST OF CAPITAL, COST OF SUBSTITUTE OR REPLACEMENT EQUIPMENT, FACILITIES OR SERVICES, DOWN TIME, PURCHASERS TIME, THE CLAIMS OF THIRD PARTIES, INCLUDING CUSTOMERS, AND INJURY TO PROPERTY.

**WARNING: DSC recommends that the entire system be completely tested on a regular basis. However, despite frequent testing, and due to, but not limited to, criminal tampering or electrical disruption, it is possible for this SOFTWARE PRODUCT to fail to perform as expected.**

# 1 Introduction

This manual provides installation and programming information for the SCW9055(D)(G)(I) and SCW9057(D)(G)(I) two-way wireless alarm system. Available hardware platforms for the 433 MHz versions are described below.

## 1.1 SCW9055/57 Model Differences

- SCW9057 includes all of the features of the SCW9055 plus the addition of 2-way audio.
- “D” models include a TL2553G or TL255GS alternate communicator module. These modules combine 3G or GSM with TCP/IP Ethernet/Internet communications. Either function can be programmed as the primary or backup communicator.
- “G” models include a 3G2055 or GS2055 alternate communicator module. The 3G2055 is a 3G wireless cellular communicator. The GS2055 is a GSM wireless cellular communicator. Either module can be programmed as the primary or backup communicator.
- “I” models include a TL255 alternate communicator module. The TL255 is an Ethernet/Internet communicator that can be programmed as the primary or backup communicator.

**Table 1-1 SCW9055/57 Models**

Model (SCW9055/57)	Frequency (MHZ)	TL2553G (D)	TL255GS (D)	3G2055 (G)	GS2055 (G)	TL255 (I)
-433	433.92	✗	✗	✗	✗	✗
D-433	433.92	✓	✓	✗	✗	✗
G-433	433.92	✗	✗	✓	✓	✗
I-433	433.92	✗	✗	✗	✗	✓

**NOTE:**

All models can communicate via phone line (PSTN) in addition to 3G or GSM cellular and Internet as described above. Refer to the associated installation guide for information on programming the communicator modules.

**NOTE:**

Only models SCW9055-433, SCW9055G-433, SCW9055D-433, SCW9055I-433, SCW9057-433, SCW9057G-433, SCW9057D-433, SCW9057I-433 are UL/ULC listed.

## 1.2 Compatible Wireless Devices

The table below lists all wireless devices compatible with the SCW9055/57 alarm panel.

<b>Table 1-2 Compatible Wireless Devices</b>	
WS, WLS, EV = 1-way wireless device. WT = 2-way wireless device.	
Descriptions	SCW9055/57-433
Wireless Keypads (see notes)	UL <sub>L</sub> WT5500-433 UL <sub>L</sub> WT5500P-433 UL <sub>L</sub> WTK5504
Proximity Tag	UL <sub>L</sub> PT4
1- Way Wireless Repeater	UL <sub>L</sub> WS4920
Door Contacts	UL <sub>L</sub> WS4945 UL <sub>L</sub> WS4965 **WS4975 EV-DW4917 EV-DW4955 ***EV-DW4975
Motion Detectors	UL <sub>L</sub> WS4904 UL <sub>L</sub> WS4904P UL <sub>L</sub> WLS914-433
Smoke Detector	UL <sub>L</sub> WS4916 UL <sub>L</sub> WS4926
Carbon Monoxide Detector	UL <sub>L</sub> WS4913
Flood Detector	WS4985
Glass Break Detectors	UL <sub>L</sub> WLS912L-433
Shock Detector	EV-DW4927
Wireless Sirens	Indoor: UL <sub>L</sub> WT4901 Outdoor: UL <sub>L</sub> WT4911
Wireless Keys	UL <sub>L</sub> WS4939 WS4949 WS4959 WS4969 WS4979 UL <sub>L</sub> WT4989
Panic Pendants	UL <sub>L</sub> WS4938 WS4938-2W
Hold-up	WLS928-433
2-way Wireless Integration module	IT-410

**Out of the Box**

SCW9055/57 alarm panel  
Mounting hardware kit  
Installation & User manuals Qty (1) ea.  
One-way, Two-way Device installation sheets as required

**Enclosures**

The SCW9055/57 main board and keypad are installed in a plastic enclosure. Tamper protection switches are installed on the enclosure, including cover opening protection and or removal from the mounting position. The enclosure top cover can only be removed using a flat screwdriver.

**Dimensions:**

227mm (L) x 141mm (W) x 42mm (D)  
WT5500 (including wall bracket):  
125mm (L) x 165mm (W) x 38mm (D)

Compatible Receivers: SG-System I, SG-System II, SG-System III and SG-System IV.

Only UL approved devices are to be used with UL/ULC listed systems.

\*\* Not available in North America, South America and New Zealand  
\*\*\* Available in North America, South America and New Zealand only

**Note:** For SIA CP-01 compliant installations, the minimum required components are: SCW9055-433 or SCW9057-433 Control Panel. Optional components that can be used with the system are: TL255, TL2553G, TL255GS, 3G2055, GS2055, WT5500(P)-433, PT4, WT4901, and WT4911.

**Note:** For SIA CP-01 installations, key fobs (WS4939, WS4938 and WT4989) cannot be used for panic/alarm functionality, only for Arming and Disarming functions.

**Note:** WT5500X-433 software version 1.4 or higher is required to display zones 33-64. If using WT5500 v1.3 or lower, CO detectors must be enrolled as zone 1-32.

## 1.3 Product Specifications

### Control and Indicating Equipment Specifications

#### Zone Configuration

- 64 Wireless zones supported and 2 hardwired zones available on the main board
- 28 zone types, 13 programmable zone attributes
- Zone configurations available: normally closed, single EOL and DEOL supervised
- 4 wireless keypads supported: model WT5500, WT5500P, WTK5504 (433MHz or 868MHz)
- 16 separate remote access keys supported: model WT4989, WS4939, WS4949, WS4959, WS4969
- With WT5500P keypad, 16 separate proximity tags supported: model PT4/PT8

#### Access Codes

- Up to 16 access codes: 16 (level 2), one system master code (level 3), one installer code (level 3), and one maintenance code
- Programmable attributes for each user code (see SCW9055/57 User Guide for details)
- 58823 access code variations (6-digit codes) for each user code

#### Warning Device output

- Integral sounder supported capable of 85 dB @ 3m
- 4 remote, wireless indoor/outdoor warning devices supported, models WT4901/WT4911
- Programmable as steady, pulsed or temporal three (as per ISO8201) and temporal four (CO alarm) output
- Fire and CO alarm notifications have priority over burglary alarm notification.

#### Memory

- CMOS EEPROM memory
- Retains programming and system status on AC or battery failure
- Data Retention: 20 years min.

#### Programmable Outputs (PGMs)

- Up to 2 programmable outputs (PGM) with 13 options
- PGM outputs are open collector type and switched to ground, rated max. 50mA

#### Power Supply

- Regulated, supervised and integral to the control unit
- Type A as per EN50131-6 Standard
- Input ratings: 16.5VAC/20VA (Min.) @50/60Hz, 100mA
- Current Draw:

No alternate communicator:

240 VAC Primary	100mA(AC)(Max)
120 VAC Primary	130mA(AC)(Max)
16.5 VAC Secondary	560mA(AC)(Max)

With alternate communicator:

240 VAC Primary	100mA(AC)(Max)
120 VAC Primary	170mA(AC)(Max)
16.5 VAC Secondary	760mA(AC)(Max)

- Plug-in transformer included
- Connected, protected by fuse in primary circuit. For EU, rated 160mA/250VAC. For NA, rated 114mA/120VAC
- Transformer secondary ratings: 16VAC, 20VA min.
- AUX Output Voltage: 12VDC, -15%/+15% when AC Input Voltage is 85% to +110% of rated value
- Aux max. draw is 100mA
- Output ripple voltage: 150mVp-p max.

- Storage device: NiMH, rechargeable battery, rated 7.2VDC (nominal)
- Battery capacity:
 

DSC part no. 17000145	1.5Ah
DSC part no. 17000152	3.6Ah
- Note: 17000145 for use with SCW9055/57 models. 17000152 for use with SCW9055/57 G, D, and I models.
- Maximum standby time 24h (AUX=0mA)/ 4h (AUX=100mA)
- Recharging time to 80% 24hours
- Recharging current:
 

DSC part no. 17000145 (1.5Ah)	125mA
DSC part no. 17000152 (3.6Ah)	250mA
- Low battery trouble indication threshold 7.2VDC
- Low Battery Trouble Restore Threshold 7.6VDC
- Battery deep discharge protection (cut-off at 6VDC)
- Main board current draw (battery only):
 

SCW9055/57 (no alternate communicator)	
Standby	160mA DC
SCW9055/57 D,G, I, SM (including alternate communicator)	
Standby	190mA DC
Transmit (alternate communicator module)	195mA DC
- Resettable fuses (PTC) used on circuit board instead of replaceable fuses
- Supervision for loss of primary power source (AC Fail), battery fail or battery low voltage (Battery Trouble) with indication provided on the keypad
- Internal clock locked to AC power frequency

#### Operating Environmental Conditions

- Temperature range: -10°C to +55°C (14°F-131°F)
- Relative humidity: 93% non condensing
- Note: UL/ULC tested for 0°C to +49°C (32°F to 122°F), 85%R.H.

#### Alarm Transmitter Equipment (ATE) Specification

- Digital dialer integral to the main control board
- Supports all major formats: SIA, Contact ID, 20BPS and Residential Dial
- Optional Dual IP/Cellular communication modules [model "D" and "D-SM" (NA only)], 3G or GSM only [model "G" and "G-SM" (NA only)] or IP only [model "I" and "I-SM" (NA only)] can be installed in the same enclosure and can be configured as primary communicator or back-up, with AES128 bit encryption for higher line security applications.

#### System Supervision Features

The SCW9055/57 continuously monitors a number of possible trouble conditions and provides audible and visual indication at the keypad. Multiple signals are indicated using scroll buttons on the LCD keypads (no priority assigned).

#### Additional Features

- Automatic inhibit (swinger shutdown) for Alarm, Tamper, Trouble signals after 3 occurrences in a given set period (see section [377]), Opt [1] alarms, [2] tamper, [3] troubles
- Programmable keypad lockout option (see section [012])
- 500 Event Buffer, date and time stamped



## 1.4 Controls & Indicators

The SCW9055/57 has four status indicators located on the front right side of the panel. See the table below for details:

**Table 1-3 Controls & Indicators - Alarm Panel**

Alarm Indicators	
✓	Ready: Panel is ready to be armed.
🔒	Armed: Panel is armed.
⚠️	Trouble: Enter [*][2] to view troubles. Yellow indicates trouble. Orange indicates RF Jam trouble.
🔄	AC Power: On=AC present. OFF=AC absent.

**Figure 1-1 Controls & Indicators - Keypad**

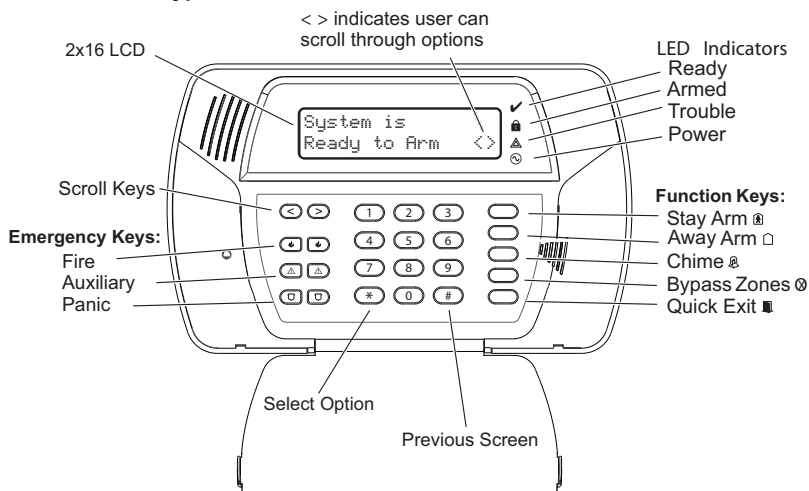

## 1.5 Data Entry

### Conventions Used in this manual

Brackets [ ] indicate numbers or symbols that must be entered on the keypad.

e.g., [\*][8][Installer Code][898] requires the following key entries: \* 8 5 5 5 5 8 9 8

[\*] indicates to the alarm system that a special command will be entered.

[8] places the alarm system in Installer Programming mode.

[5555] is the default installer code. The default installer code should be changed during initial programming of the system.

[898] indicates the particular programming section being accessed. e.g. [898] Wireless Device Enrollment, [899] Template Programming, [999] Alarm System Default.

### Special Keys:

Scroll symbols < > on the display indicate that options can be viewed by pressing the < > keys. These scroll keys can also be used to position the cursor.

The \* key is similar in function to the “ENTER” key on a personal computer. It is generally used to accept the existing programming option. It is also the first key entry for [\*] commands and can be used to enter the letters A-F when in Installer Programming mode.

The # key functions similarly to the “ESC” (escape) key on a personal computer. It is generally used to exit the current programming section or to return to the previous menu.

### Entering Letters

- In Installer Programming, enter the section you want to add text to (usually a system label).
- Use the arrow keys [<][>] to move the cursor to the letter you want to change.
- Press the number key corresponding to the letter you require. Each number button accesses three letters and a number. The first press of the number key displays the first letter. The second press displays the second letter, etc.

1 A, B, C, 1	2 D, E, F, 2	3 G, H, I, 3
4 J, K, L, 4	5 M, N, O, 5	6 P, Q, R, 6
7 S, T, U, 7	8 V, W, X, 8	9 Y, Z, 9,0
	0 Space	

4. To select lower case letters press **[\*]**, scroll to “lower case” and press **[\*]** again to select.
5. When the required letter or number is displayed use the arrow keys [**<**][**>**] to scroll to the next letter.
6. When you are finished programming the Zone Label, press the **[\*]** key, use the [**<**][**>**] keys to scroll to “Save” then press **[\*]**.
7. Continue from Step 2 until all labels are programmed.

### Entering ASCII Characters

To enter ASCII characters, press **[\*]**, scroll to “ASCII Entry” then press **[\*]** to select. Enter the corresponding three-digit number and press **[\*]** to save and exit.

!	“	#	\$	%	&	'	(	)	*	+	,	-	.	/	0	1	2	3	4	5	6	7	8
33	34	35	36	37	38	39	40	41	42	43	44	45	46	47	48	49	50	51	52	53	54	55	56
9	:	;	<	=	>	?	@	A	B	C	D	E	F	G	H	I	J	K	L	M	N	O	P
57	58	59	60	61	62	63	64	65	66	67	68	69	70	71	72	73	74	75	76	77	78	79	80
Q	R	S	T	U	V	W	X	Y	Z	[	¥	]	^	_	\	a	b	c	d	e	f	g	h
81	82	83	84	85	86	87	88	89	90	91	92	93	94	95	96	97	98	99	100	101	102	103	104
i	j	k	l	m	n	o	p	q	r	s	t	u	v	w	x	y	z	{		}	→	←	
105	106	107	108	109	110	111	112	113	114	115	116	117	118	119	120	121	122	123	124	125	126	127	160
□	「	」	ゝ	▪	ヲ	㇇	イ	ウ	エ	オ	カ	コ	ヨ	シ	-	ア	イ	ウ	エ	オ	カ	キ	ク
161	162	163	164	165	166	167	168	169	170	171	172	173	174	175	176	177	178	179	180	181	182	183	184
ケ	コ	サ	シ	ス	セ	ソ	タ	ダ	ツ	テ	ト	ナ	ニ	ヌ	ネ	ノ	ハ	ヒ	フ	ヘ	ホ	マ	ミ
185	186	187	188	189	190	191	192	193	194	195	196	197	198	199	200	201	202	203	204	205	206	207	208
ム	メ	モ	ヤ	ユ	ヨ	ラ	リ	ル	レ	ロ	ワ	ン	”	□	α	ä	β	ε	μ	σ	ρ	ϑ	∫
209	210	211	212	213	214	215	216	217	218	219	220	221	222	223	224	225	226	227	228	229	230	231	232
→	j	x	φ	£	ñ	Ö	p	q	θ	œ	Ω	ü	Σ	π	̄	y	千	斤	斤	÷		■	
233	234	235	236	237	238	239	240	241	242	243	244	245	246	247	248	249	250	251	252	253	254	255	

### Incorrect Data Entries

To change a data entry before it has been accepted by the alarm system, use the scroll keys to reposition the cursor then re-enter the digit. If the data has already been accepted, press **[#]** to exit the section then re-enter the programming section and type the data again. If you incorrectly enter 0001 in Step 2 of *Program alarm system* in Template Programming, you must either reset the alarm system to its default values (section [996], re-enroll all wireless devices and re-program the system) or re-enter the correct data in Installer Programming **[\*][8]**.

### Selecting Programming Options

To turn a programming option on or off, enter a programming section through Installer Programming. 8 spaces are displayed, each representing a separate programming option. Press the number corresponding to the option you want to activate/deactivate. Activated programming options display the option number. Deactivated options display a dash.

e.g.

Toggle Option

12- - - -7-

In the above example, programming options 1, 2, and 7 are on.

## 2 Installation

This section describes how to install and connect the SCW9055/57.

### 2.1 Mounting

1. If required, separate the front and back covers by removing the cover screw then inserting a small slotted screwdriver between the front and back covers and gently twist the screwdriver to separate.
2. Route Telephone line wiring, I/O Wiring, and AC power through the cutout in the back cover (see Fig. 2 Mounting & Wiring details). If Programming with DLS, see “4.2.1 Local Programming with PC-Link” on page 17. If using Template programming or Advanced Keypad programming, continue to the next step.
3. Secure the back cover to the wall with the hardware provided. See figure 2, Mounting & Wiring Details for hole locations.

**NOTE:** If mounting unit on a double-ganged box with the wall tamper feature, secure the back plate to the right side of the ganged box using the center mounting holes. This provides the tamper switch with unobstructed access to the wall surface.

4. Connect wiring to the terminals indicated. See Section “2.2 Wiring” on page 6 for details.
- NOTE:** Do NOT apply power until wiring is completed.
5. Connect battery cable connector to the PC Board.
- NOTE:** Ensure connector key is oriented correctly.
6. Position the cover onto the back plate. Ensure tamper switch, if used, is positioned correctly.
7. Insert cover in the top edge of the back plate at a 35° to 55° angle then snap cover in place.
8. Apply power to the system.

Once the system is wired and mounted, do the following:

- Enroll devices. Enter [\*][8][Installer Code][898]. See “2.3 Wireless Device Setup” on page 7.
- If performing Template programming, enter [\*][8][Installer Code][899]. See “4.1 Template Programming” on page 14.

**NOTE:**

- See DLS Programming on page 17 for reprogramming an existing Installation.
- AC Power must be present for the alarm system to answer incoming calls from DLS. After the initial installation 24 Hrs. is required to fully charge the standby battery.

Figure 2-1 Opening Cover

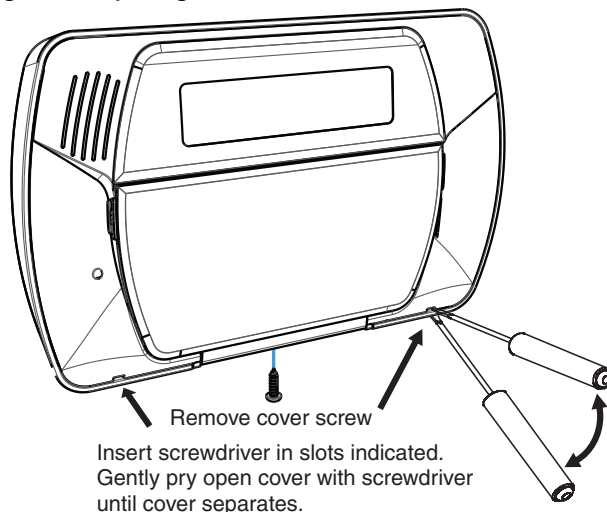
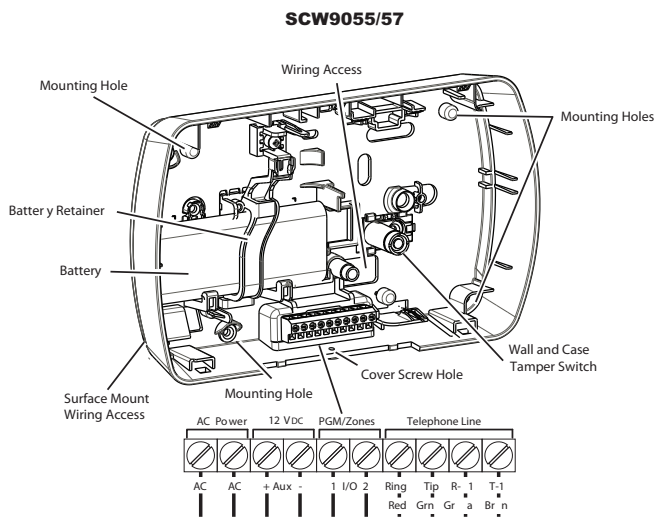
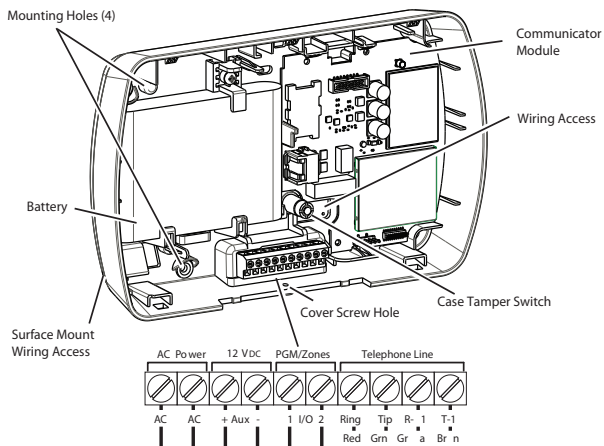

Figure 2-2 Mounting & Wiring Details



SCW 9055/57 ( G, I, D Models)



## 2.2 Wiring

**CAUTION:** The installer is responsible for ensuring that the SELV (Safety Extra Low Voltage) cables (e.g., the AUX, I/O, etc.) are routed away from the TNV circuit.

### 2.2.1. Zone Wiring

Zones can be wired for Normally Open and Normally Closed contacts with Single-end-of-line (SEOL) resistors or Double End-of-Line (DEOL) resistors. Observe the following guidelines:

- For UL/ULC listed installations use SEOL or DEOL only
- Minimum 22 AWG wire, maximum 18 AWG
- Do NOT use shielded wire
- Wire run resistance shall not exceed 100Ω. Refer to the chart below.

Burglary Zone Wiring Chart	
Wire Gauge	Max wire length to end-of-line resistor (feet/meters)
22	3000 / 914
20	4900 / 1493
19	6200 / 1889
18	7800 / 2377
Figures are based on maximum wiring resistance of 100Ω	

- Section [003] selects hardwired zone definition
  - Section [013] Opt [1, 2] selects I/O function as Zone (Input) or PGM (Output)
  - Section [206] Opt [1, 2] activates zones 33 & 34
  - Sections [133], [134] Opt [14] selects Normally Closed
  - Sections [133], [134] Opt [15] selects SEOL resistors
  - Sections [133], [134] Opt [16] selects DEOL resistors
- NOTE:** Zones 33 and 34 will not function as hardwired zones if a serial number is programmed in section [804][033], [034].

Zone Status - Loop Resistance/Loop Status

- Fault - 0Ω (shorted wire/loop)
- Secure - 5600Ω (contact closed)
- Tamper - infinite (broken wire, open)
- Violated - 11,200Ω (contact open)

### 2.2.2 PGM/Aux Power Wiring

PGMs switch to ground when activated by the alarm panel.

Connect the plus side of the device to be activated to the AUX+ terminal. Connect the minus side of the device to the PGM. Each PGM can provide 50mA output.

**NOTE:** The alarm panel can provide a maximum of 100mA of AUX current for PGMs, relays, LED's etc. Min/Max operating voltages for PGMs, relays and modules is 12VDC - 12.6VDC.

**NOTE:** Battery Voltage (6.0-8.4VDC) is boosted internally to supply 12VDC on the AUX+ output by setting Section [014] Opt. [4] to ON. This output can NOT be used for UL/ULC Fire installations. This option must be enabled for PGMs used in UL/ULC Residential Burglary installations. This output cannot be used in UL/ULC Residential Burglary installations if an alternative communicator is used with a 1.5Ah battery (DSC part# 17-145).

### 2.2.3. Telephone Line Wiring

Wire the telephone connection terminals (TIP, Ring, T-1, R-1) to an RJ-31X connector as indicated. Use 24 AWG wire minimum for wiring.

For connection of multiple devices to the telephone line, wire in the sequence indicated.

Communication format is programmed in section [350].

Telephone Call Directions are programmed in section [351]-[376].

**NOTE:** For UL listed installations, the installer must verify the communication format with the supervising station at the time of installation.

#### Normally Closed Loops - Do NOT use for UL Installations

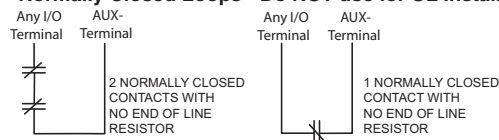

#### Single End-of-Line (SEOL) Resistor Wiring

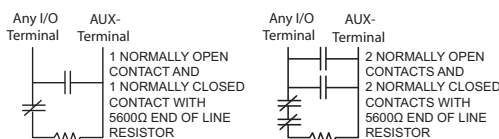
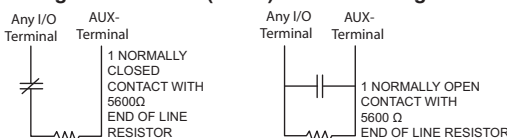

#### Double End-of-Line (DEOL) Resistor Wiring

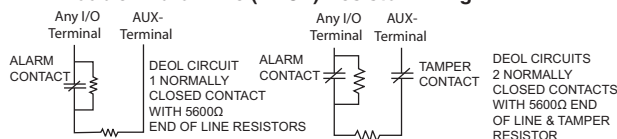

#### LED INDICATOR

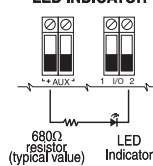

#### RELAY OUTPUT

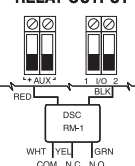

LED output with current limiting resistor and optional relay driver output

**IMPORTANT:** Minimum 6.4mm (1/4") separation must be maintained between RM-1 circuits and all other wiring

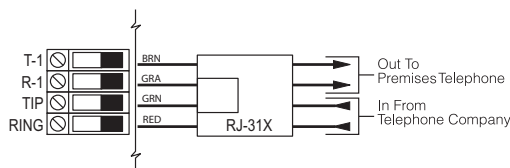

**2.2.4 Battery**

For systems without an alternate communicator, a 1500 mAh Ni-Mh battery is included to meet battery standby requirements. For systems with an alternate communicator, a 3600 mAh Ni-MH battery is included. If upgrading the battery from 1500mAh to 3600 mAh, refer to section [701] option 7.

**NOTE:** UL/ULC Residential Burglary installations require 4 Hr. battery standby time plus 4 minutes alarm annunciation.

**NOTE:** UL/ULC Residential Fire installations require 24 Hr. battery standby plus 5 minutes alarm annunciation. Requires 3600 mAh battery.

**NOTE:** Battery life is 3-5 years under typical operating conditions. Battery capacity deteriorates with age and number of charge/discharge cycles. Replace battery every 3-5 years.

**CAUTION:** Handle the battery pack with care: do not subject to mechanical shock.

**2.2.5. AC Wiring**

AC Transformer Requirements:

Primary: 120VAC, 50/60Hz., 0.33A (NA), 240VAC, 50/60Hz., 0.165A (EU)

Secondary: 16.5VAC/20VA

The following transformers shall be used:

UL/ULC Listed Installations - PTD1620U-CC

**NOTE:** Do not connect the transformer to a receptacle controlled by a switch. For UL/ULC Installations use a Class 2, power limited, plug-in transformer.

**2.3 Wireless Device Setup**

This section describes how to configure wireless devices to work with the alarm panel.

**2.3.1 Receiver Placement Test**

Receiver Placement test ensures the SCW9055/57 is located in an area with low noise and interference and can successfully receive signals from wireless devices.

To perform a receiver placement test:

- Enter Wireless Device Placement Test mode:
  - [\*][8][XXXX][904] - for wireless zones
  - [\*][8][XXXX][905] - for wireless keypad/ IT-410
  - [\*][8][XXXX][906] - for wireless sirens
  - [\*][8][XXXX][907] - for wireless repeaters
- The Yellow LED on the SCW9055/57 activates, indicating unacceptable RF traffic level or noise floor level. Once Wireless Device Placement Test mode is entered, Receiver Placement Test is continuously active until placement mode is exited or Installer programming times out.

**2.3.2 Wireless Device Enrollment**

Enrollment consists of programming the device's Electronic Serial Number (ESN) into the panel so that it can be identified when an event is communicated. Two-way devices must also initiate communication with the control panel to complete the enrollment process. The control panel assigns a unique system ID, device ID and encryption key to the device. This information is stored in the device's memory.

**NOTE:** The ESN is a 6-digit alphanumeric number located on a removable sticker on the wireless device.

**Methods of Enrollment**

Two methods of enrollment are available:

- **Quick Enroll** – Used to enroll new devices on the system (see below for procedure). The Quick Enroll procedure performs one-way and two-way enrolment communications in the background. The enrollment procedures for both types of devices are identical.
- **Manual or DLS Enroll** – See Installer Programming or DLS Programming (Section [804]). Manual or DLS enrollment of wireless keys requires the device to be physically triggered to complete the enrollment.

Enroll wireless devices in the following sequence: Keypad, Sirens, Sensors, Pendants, Wireless Keys, Repeaters.

Refer to the associated installation sheets for additional details on how to activate specific wireless devices.

**Enrolling Wireless Keypads**

During initial power up of the alarm panel, a 2-minute window is established for enrolling the wireless keypad. If the AC Power and Ready LEDs flash for the duration of this window, the keypad must be powered up and enrolled within this period. If not (i.e., The AC Power and Ready LEDs stop flashing), power down the panel then power up again to re-open the 2-minute enrollment window.





To enroll a keypad:

- Power up alarm system.
  - Connect alarm system to AC Power. The Ready and AC LEDs flash for 2 minutes.
- Power up keypad.
  - Connect keypad to AC power or install new batteries. After a few seconds the keypad may beep rapidly and the LCD displays the following: “Hold [1] and [\*] to Enroll Keypad.”
  - Press the [\*] and [1] keys simultaneously to enroll the keypad. “WFKP Enrollment Successful” is displayed.

**NOTE:** If the “Failed to Enroll” message is displayed perform the following:

- Retry the enrollment.
- Reposition the keypad closer to the control panel.
- Verify that the READY and POWER LED indicators are flashing on the panel. If not, disconnect the panel from AC and DC power sources then reconnect.
- Check for RF interference. See “2.3.2 Wireless Device Enrollment” on page 7 for more information.

### Quick Enrolling Keypads, Sirens, Wireless Keys & Repeaters

1. Enter [\*][8][5555][898]. The following is displayed: “Wireless Enrollment Mode.”
2. Activate the device as indicated below or in the device’s installation sheet.
  - Keypad: Press the [\*] and [1] keys simultaneously.
  - Siren: Power up the device, press the Tamper button or the test button to enroll.
  - Wireless key: Press any key to activate. To re-enroll on another system, press and hold  and  simultaneously for 3 seconds.
  - For IT-410 - Press Enrollment button (Note: A keypad must be enrolled before the IT-410 can be enrolled).
  - Ensure that dip switch 3 on the repeater is in the off position before quick enrolling a repeater on the SCW9055/57. Press the tamper button to enroll.
3. The Electronic Serial Number (ESN) is displayed on the keypad. Press [\*] to confirm the ESN. If the ESN is incorrect press [#] then repeat this step.
4. After successful confirmation of the ESN, the system prompts for the slot number.
  - The next available slot for the device type is displayed. Press [\*] to accept or enter the slot number. (keypads = 01- 04, Sirens = 01- 04, wireless keys = 01-16, wireless repeaters = 01-04).
  - To re-enroll a wireless key press   simultaneously for approximately 3 seconds.

### Quick Enrolling Sensors & Pendants

1. Enter [\*][8][898]. The LCD displays the following: “Wireless Enrollment Mode.”
2. Place the wireless device in the desired location.
3. Activate the device as described in the associated installation sheet. The electronic serial number (ESN) is displayed.
4. Press [\*] to confirm the serial number. If the serial number is incorrect, press [#] and repeat this step. After successful confirmation of the serial number, the system prompts for the zone number. The next available zone is displayed.
5. Enter a zone number (01-64) then press [\*] to accept. The next available zone is preloaded.  
**NOTE:** Only one device may be enrolled in each zone. If a zone already has a device enrolled, press [\*] to overwrite the zone or [#] to enter another zone number.
6. After successful entry of the zone number, the system prompts for the zone type. (The recommended zone type is displayed). Press [\*] to accept the zone type or enter:
 

Device Type	Zone Definition
2 Door/Window Contact	[01] Delay 1
3 PIR or Glassbreak	[05] Interior, Stay-Away
4 Smoke Detector	[88] Standard 24-Hour Fire (Wireless)
5 Pendant	[16] 24-Hour Panic
6 & 9 Wireless Key	N/A
A Wireless Repeater	N/A
7. After successful entry of a valid zone type, the alarm panel automatically enters individual placement test mode for the zone that was enrolled. “Activate Device for Test, Exit #” is displayed on the screen. The device may now be placement tested. See below for details.
8. Press the [#] key to return to the quick enroll screen. Repeat the above procedure for the next zone.

### Quick Enrolling Proximity Tags

If this function is available on the keypad, the [\*][5] menu provides the option to assign a proximity tag to an access code once the access code has been entered. Swipe the tag to enroll it during user access code assignment.

**NOTE:** To unenroll a proximity tag, the user code must be deleted.

### Manual Enrollment

To manually enroll a 2-way wireless device:

1. Enter [\*][8][5555][804].
2. Select the programming section corresponding to the device type:
  - Wireless sensors and pendants [804][001]-[064]
  - Wireless Key [804][101]-[116]
  - Wireless Keypad/ IT-410 [804][201]-[204]
  - Wireless Siren [804][301]-[304]
  - Wireless Repeater [804][401]-[404]
3. Enter the device serial number.
4. Activate the device as indicated in the device’s installation sheet. This can be done while in Installer Programming or after exiting. The device is now enrolled.

### 2.3.3 Wireless Device Placement Test

Perform wireless device placement testing on keypads, sirens, sensors and repeaters only.

- During placement test, the sensitivity of the wireless receiver is reduced significantly. This is done to ensure that, if consistent good placement test results are generated with reduced sensitivity, the product should have more than adequate range when placement test exits and the sensitivity level returns to normal. During placement test, try to avoid tripping multiple devices at the same time as this may cause collisions. A collision may cause a bad placement test result, despite having adequate coverage between the receiver and the transmitter.
- During placement test, the wireless receiver will require 3 out of 4 wireless packets to be received before a good placement test result is obtained. Outside of the placement test mode, one wireless packet received is enough to generate an alarm or trouble condition.
- This test is NOT required for wireless keys or panic pendants. Verify that wireless keys operate within the desired operating area by arming/disarming the system.
- Test each wireless device a minimum of 5 times to ensure the location is good. Ideally all 5 attempts should provide a good placement test result.
- If a device tests bad, reposition it and test again. A slight change in placement, or the orientation of the transmitter, can cause significant differences in the signal strength and range of a wireless device.
- Avoid mounting wireless transmitters on metal door or window frames whenever possible.

**NOTE:** The indoor siren sounds during placement test, even if it is disabled in section [804][311]-[314] option 1. The outdoor siren sounds during placement test only if section [804][311]-[314] option 1 is enabled.

#### Wireless Zone Placement Test

1. To placement test a zone, press [\*][8][XXXX][904]. [XXXX] represents the installer code. The LCD displays the following: "Select Device for Test <>."
2. To perform a placement test on an individual zone, type the 2-digit zone number (01 to 64). To perform a global placement test on a zone, type [00]. In this mode, all wireless zones, keypads, sirens and repeaters are placement tested at the same time. To perform another Wireless Zone Placement test, exit the global placement test by pressing [#] and begin a new test.
3. Place the wireless device(s) in the intended mounting location(s).
4. Activate the device(s) as described in the associated installation sheet. The device name and zone number are displayed on the LCD.
  - If the alarm system receives a STRONG signal, the bell sounds once and "Location is Good" is displayed on the LCD.
  - If the alarm system receives a WEAK signal, the bell sounds 3 times and "Location is Bad" is displayed on the LCD.
  - If the alarm system indicates no response, reposition the wireless device(s) and repeat the test.
  - For individual placement tests, repeat step 2-3 for each device.
5. When placement testing is complete, press [#] to exit Installer Programming.

#### NOTE:

Two-way wireless keys must be activated by pressing any key before they become functional.

To placement test a wireless keypad, press number keys 0-9.

To placement test a wireless siren or repeater, press the Test button or tamper the device.

### 2.3.4 Individual Wireless Device Placement Test

Individual placement testing can be performed on wireless devices. Use the scroll keys or enter a 2-digit entry to select a specific device.

1. To individually test wireless devices, press:
  - [\*][8][XXXX][905] - for wireless keypads/IT-410
  - [\*][8][XXXX][906] - for wireless sirens
  - [\*][8][XXXX][907] - for wireless repeaters

**NOTE:** [XXXX] represents the installer code (default 5555).
2. Select the wireless device you want to placement test by typing the number of the device. In section [905], type 01-04 for keypads and IT-410. In section [906], type 01-04 for siren 1 to 4. In section [907] type 01-04 for wireless repeater 1-4. Alternatively, scroll to the desired device and press [\*] to begin the individual placement test.
3. Place the wireless device in the intended mounting location.
4. Activate the device as described in the associated installation sheet.
  - If the alarm system receives a STRONG signal the bell sounds once and "Location is Good" is displayed on the LCD.
  - If the alarm system receives a WEAK signal the bell sounds 3 times and "Location is Bad" is displayed on the LCD.
  - If the alarm system indicates no response, reposition the wireless device and repeat the test.
5. Repeat Step 2-3 for each device. Once the placement test is complete for the device, press [#] once to select the next similar device.
6. When placement testing is complete, press [#][#][#] to exit Installer Programming.

## 2.4 Alternate Communicator Module Setup/Initialization

After system installation and programming, ensure that the following sections are programmed:

- central Station Phone Number, (Template Programming - Entry 5) (if applicable, in sections [301]-[303] & [305])
- account code, section [310], (Template Programming - Entry 6)
- communications Format, Section [350]- set to [03] Contact ID or [04] SIA FSK
- alternate communicator Module Enable section [382] Option [5] - set to "alternate communicator module enabled"

## 3 Operation

### 3.1 Operating Modes

#### 3.1.1 – Away Arming

Away Arming arms the entire system including the perimeter and interior devices. The Ready light must be on to arm the system. If the Ready light is off, ensure all protected doors and windows are secure or bypassed. To arm in Away mode, press and hold the Away function key for 2 seconds or enter a valid user code and leave the premises through a door programmed as Delay. The Armed light turns on when a function key is pressed or an access code is entered. If the Audible Exit Delay option is enabled, the keypad beeps once every second during the exit delay (and three times a second during the last 10 seconds) to alert the user to leave. The Ready light turns off when the Exit Delay ends.

**NOTE:** To arm in Away mode, exit through a door programmed as Delay zone after pressing the Away key.

**NOTE:** In Away Arming mode, manually bypassed zones are logged and communicated to the central station.

#### 3.1.2 – Stay Arming

**NOTE:** Requires zone definitions 05 Interior Stay/Away, 06 Delay Stay/Away, or 32 Instant Stay/Away for this function to work.

Stay Arming is intended to arm the perimeter of the premises while permitting movement within. The Ready light must be on to arm the system. If the Ready light is off, ensure all protected doors and windows are secure or bypassed. To Stay arm the system, press and hold the Stay function key for 2 seconds or enter a valid user code and stay within the premises (do NOT violate a door programmed as Delay). The Armed light turns on once a function key is pressed or an access code is entered. If the Stay function button is used, the keypad will not beep during the exit delay and the user can still exit the building without the system reverting to Away mode. When a user code is used, the keypad beeps if the Audible Exit Delay option is enabled. The Ready light turns off when the exit delay ends.

**NOTE:** In Stay Arming mode, all auto-bypassed stay/away and night zones are logged and communicated to the central station.

#### 3.1.3 – Night Arming

Night arming arms the perimeter and restricts movement to designated interior areas. If night zones are programmed, entering [\*][1] while Stay armed activates all interior zones except those programmed as night zones. The panel can also be Night armed by pressing the Night Arm key for 2 seconds. The Ready light must be on or the system must be Stay armed in order to enable Night arming. In Night mode only night zones (Zone definition 37) are bypassed. When activated, acknowledgment beeps are not sounded, the exit delay is silent and the panel logs “Armed in Night Mode.” If no night zone types are programmed, the system arms in Away mode and the panel logs “Armed in Away Mode.”

**NOTE:** In Stay Arming mode, all auto-bypassed night zones are logged and communicated to the central station.

#### 3.1.4 – Disarming

The user must enter through a door programmed as Delay. Upon entering, the keypad emits a steady entry delay tone (and a pulsing tone during the last 10 seconds of entry delay) to alert the user to disarm the system. To disarm the system, enter a valid user code, present a proximity tag or use a wireless key. If an alarm occurred while the panel was armed, the keypad displays “Alarm in Memory” and the zone(s) that went into alarm during the armed period. Press the [#] key to return the keypad to the Ready state.

### 3.2 Language Selection

The keypad can be programmed to display messages and labels in different languages. Languages can be selected before the keypad is enrolled on the system. Perform the following when in “Ready to Arm” mode or at the Installer Programming menu:

- (1) Press and hold both scroll keys [<>] simultaneously until language options are displayed.
- (2) Scroll to a language then press [\*] to select.

### 3.3 [\*] Commands

The following is a list of available [\*] commands:

[*][1]	Bypass (disarmed state)/Reactivate Stay/Away Zones (armed state)
[*][2]	Display Trouble Conditions
[*][3]	Display Alarm Memory
[*][4]	Door Chime Enable/Disable
[*][5][Master/Supervisory Code]	User Code Programming and Proximity Tag Enrollment
[*][6][Master/Supervisory Code]	User Functions
[*][7][1/2]	Command Outputs 1 and 2
[*][8][Installer Code]	Installer Programming
[*][9][User Code]	No-Entry Arming
[*][0]	Quick Arm (disarmed state)/Quick Exit (armed state)

#### [\*][1] – Bypass/Re-activate Stay/Away and Night Zones

Press [\*][1] to enter the bypass mode. If the Code Required for Bypass option is enabled, enter a valid user code. The keypad will display ‘Scroll to Bypass Zones.’ The keypad will display the programmed zone labels for the zones and include the letter ‘O’ in the bottom, right corner if the zone is violated or the letter ‘B’ if the zone is bypassed. Scroll to the appropriate zone and press the [\*] key to change the bypass status (or enter the 2-digit zone number). Once the correct zones are bypassed, press [#] to exit.

Additional Bypass Commands:

Bypass Recall:	Press [99].	The keypad will recall the last group of zones that were bypassed.
Clear Bypass:	Press [00].	The keypad will clear the bypass on all zones.
Save Bypass:	Press [95].	The keypad will save which zones are manually bypassed.
Recall Save:	Press [91].	The keypad will recall the bypassed zones that were saved.



Re-activate Stay/Away and Night Zones:

Press [\*][1] when the system is armed in the Stay mode to change the armed status to Away mode or Night mode. The system will add the Stay/Away zones back into the system after the exit delay time expires.

If any zones are programmed as Night Zones (zone definition 37) pressing [\*][1] will activate the Night mode instead of Away mode. Only Night Zones will be bypassed.

### [\*][2] – Trouble Display

Refer to Section 6: Testing & Troubleshooting, for troubleshooting assistance and a detailed description of all trouble conditions.

### [\*][3] – Alarm Memory Display

Press [\*][3] to view alarms that occurred during the last armed period. The message “Scroll to view Alarms” is displayed. Use the scroll keys < > to display zones that went into alarm. To clear the memory, arm then disarm the system.

### [\*][4] – Door Chime Enable/Disable

Press [\*][4]. The keypad emits 3 rapid beeps to indicate that the door chime feature is enabled or a steady 2-second tone to indicate it is disabled. The same function can be performed by pressing and holding the Chime function key for 2 seconds.

### [\*][5] – Program User Codes

The following table identifies available user codes:

Code	Type	Function
[01] – [16]	General User Codes	Determined by attributes programmed below
[40]	Master Code	All attributes described below

### Programming User Codes

Press [\*][5] followed by the master code. The keypad displays the first user (01) and includes the letter “P” if the user code is programmed. Scroll to a user number and press [\*] to program the user (or enter the 2-digit user number). Enter a new 4 or 6-digit user code or press [\*] to delete the user code. After the code is programmed or deleted, scroll to another user number or press [#] to exit.

**NOTE:** Proximity tags can be assigned to a programmed user code on WT5500P keypads. After assigning a user code, swipe the tag to assign it to the user. A T is displayed in the lower right hand corner of the user code indicating that a tag is associated with it. To delete a proximity tag, the user code must be deleted. Refer to the Proximity Tag Installation Sheet for details. The proximity tag can be used in place of the access code for any of the featured referred to in the Operation section of this manual.

### Programming User Attributes

Press [\*][5] followed by the master code or supervisor code. Press [9] followed by the 2-digit user number to view user attributes. To change user attributes, press the number corresponding to the attribute or scroll to the desired attribute and press [\*]. When the correct attributes are assigned to the user, press [#] to exit. To change the attributes for another user, press [9] followed by the 2-digit user number. When finished, press [#] to exit.

#### NOTE:

- These attributes affect the operation of wireless keys.
- Wireless key numbers (01-16) correspond with user access codes (01-16).
- Duress codes are not valid when entering [\*][5], [\*][6] or [\*][8] sections.
- Duplicate codes and codes that are  $\pm 1$  of an existing code can not be programmed.

- [1] Supervisor’s Code: This code is used for validation when entering the [\*][5] User Code Programming section and [\*][6] User Functions section. Note, the supervisor’s code can only validate programming for codes with equal or lesser attributes. The supervisor’s code also allows the user to create bypass groups if an access code is required to enter [\*][1] Bypassing.
- [2] Duress Code: Duress codes are standard user codes that transmit the Duress Alarm Reporting Code whenever the code is entered to perform any function on the system.
- [3] Bypass Zones: The user can manually bypass zones if bypassing requires an access code.  
Phone Access: This attribute is used to specify which users can access the system remotely.
- [4] Note: After 5 invalid access codes, remote access is locked out. The invalid access codes timer is cleared every 60 minutes. Valid access codes do not reset the invalid access code count.
- [7] Bell Squawk On Arming/Disarming: The panel squawks the bell when the user arms using the Away function key and a user code, or if the away function key is pressed on an identified wireless key.
- [8] One-time Use Code: The one-time-use code allows unlimited arming but only permits a single disarming once a day. The Disarm function is restored at midnight.

### [\*][6] – User Functions

To access the User Functions section, press [\*][6] followed by the master or supervisor code. Select one of the functions described below by pressing the corresponding number or scrolling to the desired option then pressing [\*].

- [1] Program Time and Date: Enter the time and date using the following format [HH:MM] [MM/DD/YY]. Program the time using military standard (e.g., 8:00 pm = 20:00 hours).
- [2]-[3] Future Use

- [4] System Test: The system activates the siren output on medium volume for 2 seconds followed by full volume alarm for 2 seconds. All display lights and LCD pixels turn on.
- [5] System Serv/DLS: Installer Programming, either by DLS or via the keypad ([\*][8]), is enabled for 6 hours.
- [6] User Initiated DLS: The panel attempts to call the DLS computer.
- User Walk Test Mode: This mode tests the operation of each detector in the system. Press [\*][6][Master Code][8] to initiate Walk Test. While in Walk Test, the Ready, Armed, and Trouble LED's on the keypad flash to indicate that the test is active.
- [8] When a zone is violated during the test, a 2-second tone sounds on all system keypads to indicate that the zone is working correctly. Re-entering [\*][6][Master Code][8] exits Walk Test. The system automatically ends the test after 15 minutes without zone activity. An audible warning (5 beeps every 10 seconds) is sounded, beginning 5 minutes before the test ends.

**NOTE:** Do not activate [F]ire, [A]uxiliary and [P]anic keys, or Fire and CO zones during a walk test. If an [F], [A], or [P] key is pressed during a walk test, or if a fire or CO alarm is detected, walk test ends automatically and the reporting codes for the alarm are sent immediately to the monitoring station.

- Late to Open Control: Notifies a user if their alarm system is not disarmed by a programmed time of day (see Late to Open Time of Day). If the system is not disarmed at the programmed time, an alert is sent to the monitoring station. The keypad displays "Late to Open is Enabled" and sounds a beep if [9] is pressed within the User Functions menu when this feature is off. The LCD keypad displays "Late to Open is Disabled" and sounds an error tone if [9] is pressed within the User Functions menu when this feature is on.
- [9]

- Late to Open Time of Day: Sets the time for Late to Open Control programmed for attribute [9] operation. Valid entries are 00:00 - 23:59. Entering 99:99 disables the late to open feature for that day. After [0] is pressed in the [\*][6] menu, acknowledge beeps are sounded and the message "Press [\*] for <> Sunday" is displayed on the keypad. Pressing [>] scrolls through each day of the week from Sunday to Saturday. While in the Late to Open menu, entering keys 1-7 also selects the day.
- [0]

### Additional Keypad Functions

The following additional keypad functions are available:

Event Buffer:	View the 500-event panel buffer
Brightness Control:	Adjust the display backlighting level for optimal viewing
Contrast Control:	Adjust the display contrast level for optimal viewing
Buzzer Control:	Adjust the keypad buzzer tone for optimal sound
SMS Phone Number Programming:	Program up to 8 phone numbers for the panel to accept incoming SMS commands

### [\*][7][1 or 2] – Command Outputs (1&2)

Press [\*][7] then [1] or [2]. If the Command Output Code Required option is enabled, enter a valid user code. The panel activates a command output assigned to any PGM.

### [\*][8] – Installer Programming

Press [\*][8][Installer Code] to enter Installer Programming. Installer programming allows the installer to program all system functions. Refer to section 5: Installer Programming, for details.

### [\*][9][User Code] – No-Entry Arming

Press [\*][9] followed by a valid user code. The system arms in the Stay mode after the exit delay expires and removes the entry delay. All zones programmed as Delay function in the same way as Instant zones. The system flashes the Armed light to indicate that it is armed with no entry delay.

### [\*][0] – Quick Arm/Quick Exit

Quick Arm: When disarmed, press [\*][0] to arm the system. Quick Arm is equivalent to entering your user code.

Quick Exit: When armed, press [\*][0] to activate Quick Exit. Quick Exit allows you to exit the premises without disarming the system. The system allows a single zone programmed as Delay to be violated and restored once during the following 2 minute time period without changing the status of the system.

## 3.4 Function Keys

The keypad has 5 programmable one-touch function keys located in a column down the right-side of the keypad. These keys can also be activated by pressing and holding number [1] through [5] respectively for 2 seconds. The default for these keys are as follows:

[1] Stay Arm	[4] Bypass
[2] Away Arm	[5] Quick Exit
[3] Chime Enable/Disable	

## 3.5 System Removal Prevention

The SCW9055/57 includes a feature to prevent intruders from disabling the system by removing it from the wall.

This feature operates as follows:

1. When an entry delay is started, the panel notifies the alternate communicator.
2. The communicator establishes contact with the network as soon as it receives the above notification.
3. If a system tamper is detected, the panel notifies the communicator, sending a burglary event to the central station.

## 4 Programming

The SCW9055/57 can be programmed using the following methods:

Programming Method	Description	Procedure
Template Programming	Allows the minimum required data to be programmed. It also allows for the setup of DLS downloading software.	Press [899] at the “Enter Section” screen. See Template Programming below for details.
DLS Programming	Allows programming to be downloaded using DLS-IV™ software. <ul style="list-style-type: none"> <li>DLS programming can be performed locally with a PC-Link cable and a PC with DLS-IV software installed.</li> <li>DLS programming can be performed remotely via telephone line, Cellular network or the Internet.</li> </ul>	DLS Programming can be set up from Template Programming (See Steps 3, 4 and 5) or from Installer Programming (See programming sections [401]-[404]).
Installer Programming	Allows direct access to all programming sections. Template programming is accessed from here.	Press [*][8][Installer Code] while the system is disarmed. Refer to Installer Programming in section 4.3 for details.

### 4.1 Template Programming

Template Programming allows the installer to quickly program the minimum functions required for basic operation. The installer is prompted to enter a 4-digit code that selects predefined zone definitions, reporting code formats, and troubles/restores (see the tables for digits 1 - 4 below).

Perform the following after completing the hardware installation. Ensure you have the information listed below available for programming. Record this information in “5.3 Programming Worksheets” on page 20 for future reference:

- Monitoring Station Telephone Number - Provided by your alarm monitoring service.
- Monitoring Station Account Code - Provided by your alarm monitoring service.
- Downloading Access Code.
- Entry Delay - Installer defined.
- Exit Delay - Installer defined.
- Installer Code - Programmable, unique 4-digit code. The default value is [5555].

To perform template programming:

1. At the “Ready to Arm” screen, enter [\*][8][5555][899].
2. At the “Enter Data” screen, enter [0001] to accept the existing default programming. See the tables below for details of digits 1-4.

**NOTE:** Once this section has been entered, the Installer cannot exit until all sections are completed. Enter new data and/or press # key to accept the displayed data and proceed to the next section. Changing a single digit, then pressing the # key advances to the next section but does not save the changed data. Enter all 4 digits or scroll to the end of template programming and exit to save data.
3. After entering [0001], the first telephone entry is displayed. Enter the monitoring station telephone number after the “D.” Press [#] to complete the entry.
4. After programming the first telephone number, enter a system account code.
  - The system account code can be any 6-digit combination of numbers (0-9) and letters (A-F). If the system account code is 4-digits, the last two digits must be “FF.”
  - To enter letters A through F, press [\*] then the numbers 1 through 6 for the letter A through F respectively. Press [\*] again to revert back to decimal entry. E.g., to enter “1234FF” press [1234\*66]. See section [310] for additional details.
5. After programming the system account code, the downloading access code is displayed. Enter the new downloading access code or press [#] to proceed to the next step. See section [403] for additional details.
6. The entry delay is the amount of time given to disarm the alarm system, after entering the premises through a delay type zone, before an alarm is sounded. Press [>][>][>] to accept the default time of 30 seconds (030) or enter an entry delay between 001 and 255. E.g., Press 020 for a delay of 20 seconds. See section [005] for additional details.
7. The exit delay is the amount of time given to exit the premises after pressing the Arm key before the alarm system is armed. Press [>][>][>] to accept the default time of 120 seconds or enter an entry delay between 001 and 255. E.g., press 030 for a delay of 30 seconds. See section [005] for additional details.

8. After programming the exit delay, enter a 4 or 6-digit installer code depending on the value in section [701] option 5. See “[006] Installer Code” on page 20 for installer code details.
9. Press [#] to exit Template Programming.

• **Digit 1** selects 1 of the following 6 options for Zone definitions for the first 8 zones. A “0” in the digit 1 location indicates that the default settings for the first 8 zones are in place unless overridden. See Section [001]-[002] on page 20 for defaults.

Option	Zn1	Zn2	Zn3	Zn4	Zn5	Zn6	Zn7	Zn8
1	1	3	3	3	4	4	4	4
2	1	3	3	5	5	5	5	88
3	1	3	3	5	5	5	5	87
4	1	1	3	3	3	3	3	3
5	1	3	3	6	5	5	5	5
6	1	3	3	6	5	5	5	88

Refer to “[001]-[004] Zone Definitions” on page 42 for details

Zone Definitions (Options 1- 6)	
1	Delay 1
2	Delay 2
3	Instant
4	Interior
5	Interior Stay/Away
6	Delayed Stay/Away
87	Delayed 24Hr. Fire (Wireless)
88	Standard 24 Hr. Fire (Wireless)

• **Digit 2** selects 1 of the following 6 options for Reporting Codes

Opt#	Phone Line 1	Programming Section	Phone Line 2	Programming Section
1	Disabled	[380] Opt 1 OFF	Disabled	
2	SIA automatic reporting codes enabled	[350] 1st Phone # [04] [380] Opt 1 ON [381] Opt 3 OFF	SIA automatic reporting codes enabled	[350] 2nd Phone # [04]
3	Contact ID reporting codes enabled	[350] 1st Phone # [03] [380] Opt 1 ON [381] Opt 7 OFF	SIA automatic reporting codes enabled	[350] 2nd Phone # [04] [381] Opt 3 OFF
4	SIA automatic reporting codes enabled	[350] 1st Phone # [04] [380] Opt 1 ON [381] Opt 3 OFF	Residential dial enabled	[350] 2nd Phone # [06]
5	Contact ID reporting codes enabled	[350] 1st Phone # [03] [380] Opt 1 ON [381] Opt 7 OFF	Residential dial enabled	[350] 2nd Phone # [06]
6	Contact ID reporting codes enabled	[350] 1st Phone # [03] [380] Opt 1 ON [381] Opt 7 OFF	Contact ID reporting codes enabled	[350] 2nd Phone # [03]

• **Digit 3** selects 1 of the 8 following options

Option	Common Group	Selected Troubles	Openings/Closings	Zone Restores	DLS/Installer Lead In/Out
1	✓			✗	✗
2	✓	✓		✗	✗
3	✓		✓	✗	✗
4	✓	✓	✓	✓	✗
5	✓	✓			✗
6	✓		✓		✗
7	✓	✓	✓		✗
8	✓				

✓ indicates included, Blank indicates default setting, ✗ indicates disabled

• **Common Group** - Sets all Reporting Codes to Automatic

Description	Phone 1	Phone 2	Sections
Set all reporting codes to automatic			[320] - [348] FF
Alarm/restore call directions enabled	✓	✗	[351][1] ON, [2] OFF
Tamper/restore call directions disabled	✗	✗	[359][1] OFF, [2] OFF
Opening/closing call directions disabled	✗	✗	[367][1] OFF, [2] OFF
Maintenance call directions enabled	✓	✗	[375][1] ON, [2] OFF

- **Selected Troubles** - Enables the following Troubles

Trouble	[345] Alarms	[346] Restore
Battery	FF	FF
AC Failure	00	00
Fire Trouble	FF	FF
Aux PS	FF	FF
TLM	XX	00
General System	00	00
FF = General System Trouble, 00 = Disabled, XX = Not transmitted		

- **Openings & Closings** - Sets Residential Dial Reporting Codes for all openings and closings

Users	CLOSINGS, Residential Dial Reporting Codes								Section
1-8	51	52	53	54	55	56	57	58	[339]
9-16	61	62	63	64	65	66	67	68	[339]
40	99	FF	FF	FF	FF	XX	XX	XX	[341]
Users	OPENINGS, Residential Dial Reporting Codes								Section
1-8	11	12	13	14	15	16	17	18	[342]
9-16	21	22	23	24	25	26	27	28	[342]
40	98	FF	XX	XX	XX	XX	XX	XX	[344]
Enable Opening/Closings call directions for phone 2 FF=Communicates in automatic mode, XX=Not used									[367] Opt 2 ON

- **Installer Lead-in/Lead-out and DLS Lead-in/Lead-out**

DLS Lead In Sect [347] Opt 4	DLS Lead Out Sect [347] Opt 5	Installer Lead Out Sect [347] Opt 11	Installer Lead In Sect [347] Opt 12
Disabled for all template options except option 8			

**Digit 4** indicates/selects one of the three following DLS connections

Option	Double Call Sect [401] Opt 1	Call Back Sect [401] Opt 3	User Call Up Sec [401] Opt 4	#Rings Sect [406] Opt 3
1	✗	✗	✗	000
2	✓	✗	✗	008
3	✓	✓	✗	008
4	✓	✗	✓	008

## 4.2 DLS Programming

### 4.2.1 Local Programming with PC-Link

Follow the steps below in the sequence indicated to set up local programming using DLS:

1. Connect AC Wiring before mounting the back plate.
 

**NOTE:** In a new installation, the backup battery requires 24 Hrs. charging. AC Power is required for PC-Link Programming until battery is charged.
2. Remove the front cover from the backplate, taking care not to disconnect the alternate communicator module and battery connectors.
3. Initiate a DLS PC-Link session on the DLS computer.
4. Plug in PC-Link header.
5. Initiate DLS session on the DLS computer.

**Figure 4-1PC-Link Connection**

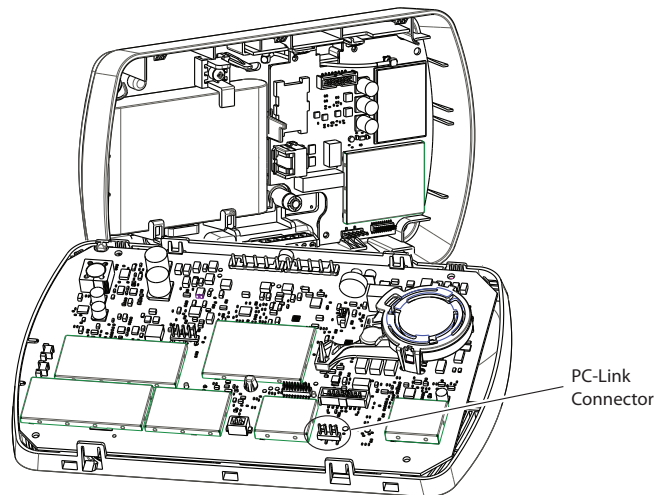

**NOTE:**Connecting the DLS PC to the system automatically initiates the connection.

6. When the session is complete, remove the PC-Link cable from the alarm system.
7. Complete the installation.

### 4.2.2 Local Firmware Upgrade

1. If the unit is mounted on the wall, remove the front cover from the back plate or remove the entire unit from the wall. Plug in the DLS header. Power down and power up the unit.
 

**NOTE:** The DLS session must be initiated within 10 seconds of power up. Do not attempt to perform a firmware upgrade if low battery trouble is present.
2. Open the Flash Utility application within DLS, select the latest firmware file from the Web or browse to the saved flash file on your hard drive. Follow the steps as prompted by the Flash Utility application. A message is displayed when download is complete.
3. Once the firmware update is complete, the panel powers up.

### 4.2.3 Remote Firmware Upgrade

The panel firmware can be upgraded remotely via communicator. If a firmware upgrade is available or if the installed firmware is faulty, the latest version is installed. During the update, "FW Updating" is displayed on the on-board LCD. If the firmware update fails, "System Error" (top line) "Service Req." (bottom line) is displayed.

The Panel performs a firmware update under the following conditions:

- The Panel is not armed
- No AC trouble is present
- No low battery trouble is present
- No FTC trouble is present
- Every alarm in memory has been viewed
- No events are being communicated

### 4.2.4 Remote Programming (via telephone line)

Refer to Section "[401] First Downloading Options" on page 30 and page 57 for details.

**NOTE:**AC Power must be present for the alarm system to answer incoming calls from DLS.

## 4.3 Installer Programming

Enter [\*][8][Installer Code].

The system prompts for a 3-digit programming section number (refer to Chapter 5 for programming details).

## 5 Advanced Programming

### 5.1 How to Program

To help reduce programming time and eliminate errors, fill in the Programming Worksheet with the required programming defaults before programming the system.

To enter Installer Programming, press [\*][8][Installer Code]. The LCD keypad displays “Enter Section.” An error tone sounds if an incorrect installer code is entered. Press [#] to clear any key presses and try again.

**i** The default installer code is [5555].

The Armed and Ready lights indicate programming status:

<b>Armed Light ON</b>	Panel waiting for 3-digit section number
<b>Ready Light ON</b>	Panel waiting for data to be entered
<b>Ready Light FLASHING</b>	Panel waiting for HEX data to be entered

**i** You cannot enter Installer Programming while the system is armed or in alarm.

#### 5.1.1 Programming Toggle Options

Enter a 3-digit programming section number:

- The Armed light turns OFF and the Ready light turns ON.
- The keypad displays which toggle options are ON or OFF according to the table below:

Option ON	Option OFF
# Displayed	Dash [-] Displayed

- To toggle an option ON or OFF, press the corresponding number on the keypad. The display changes accordingly.
- When all the toggle options are configured correctly, press the [#] key to exit the program section.
- The Ready light turns OFF, the Armed light turns ON and the LCD displays “Enter Section.”

#### 5.1.2 Programming Decimal and Hexadecimal (HEX) Data

- Enter a 3-digit programming section number
- The Armed light turns OFF and The Ready light turns ON
- Enter data in the spaces provided

For sections that require multiple 2 or 3 digit numbers, the keypad emits a double-beep after each 2 or 3 digit entry and moves to the next item in the list. After the last digit in the section is entered, the keypad beeps rapidly 5 times and exits the programming section. The Ready light turns OFF, the Armed light turns ON and the LCD displays “Enter Section.”

For sections that do not require data for every box (such as phone numbers) press the [#] key to exit the programming section after entering all the required data. The Ready light turns OFF, the Armed light turns ON and the LCD displays “Enter Section.”

At any time the [#] can be pressed to exit a programming section. All changes (excluding Template Programming) are saved.

#### Hex Digits

In addition to the standard digits 0-9, HEX digits and special dialer functions can also be programmed.

To enter a HEX digit:

1. Press the [\*] key to begin HEX programming. The Ready light will FLASH.
2. Press the number corresponding to the HEX digit required (1=A, 2=B, 3=C, 4=D, 5=E, 6=F). The Ready light will continue to FLASH.
3. Press [\*] again to return to normal decimal programming. The Ready light will turn ON.

#### 5.1.3 How to Exit Installer Programming

To exit Installer Programming, press the [#] key at the “Enter Section” screen.

#### 5.1.4 Viewing Programming

The keypad immediately displays all programmed information when a section is entered. Use the arrow keys (<>) to scroll through the available data. Scroll past the end of the data displayed or press the [#] key to exit the section.

## 5.2 Index to Programming Worksheets and Descriptions

Programming Option	PWS/Desc.	Programming Option (cont.)	PWS/Desc.
[001]-[004] Zone Definitions.....	20/42	[404] Panel ID Code.....	30/58
[005] System Times.....	20/44	[405] Double Call Timer.....	30/58
[006] Installer's Code.....	20/44	[406] Number of Rings to Answer On.....	30/58
[007] Master Code.....	20/44	[501]-[502] PGM Output Attributes.....	31/58
[008] Maintenance Code.....	20/44	[591]-[592] Inactivity Timers 1&2 Start/End Times.....	31/59
[009] I/O Programming.....	21/44	[600]-[601] 2-way Audio Control Options.....	32/60
[012] Keypad Lockout Options.....	21/45	[609] Module Tamper Rep. Codes.....	32/60
[013] First System Options.....	21/46	[610] Alternate Com. Receiver Trouble Rep. Codes.....	32/60
[014] Second System Options.....	21/46	[611] Repeater Tamper/AC Loss Rep. Codes.....	32/60
[015] Third System Options.....	21/47	[700] Automatic Clock Adjust.....	33/60
[016] Fourth System Options.....	22/47	[701] First International Options.....	33/60
[018] Sixth System Options.....	22/48	[702] Second International Options.....	33/61
[023] Tenth System Options.....	22/48	[703] Delay Between Dialing Attempts.....	33/61
[024] Eleventh System Options.....	22/49	[800] Door Chime Options for Zones 1-64.....	33/61
[030] Zone Loop Response Options.....	22/49	[804] Wireless Programming.....	34/61
[101]-[164] Zone Attributes.....	23/49	[001]-[064] Wireless Zone Programming.....	34/61
[167] Alt. Comm. Communications Wait for Ack.....	23/50	[081] Wireless Supervisory Window.....	34/62
[168] Daylight Saving Time Begin.....	23/50	[082]-[089] Zone Transmitter Supervision.....	35/62
[169] Daylight Saving Time End.....	23/50	[101]-[116] Wireless Key Serial Number.....	35/62
[170] PGM Output Timer.....	23/50	[141]-[156] Wireless Key Function Key Options.....	35/62
[176] Cross Zone/Police Code Timer.....	24/51	[181]-[182] Wireless Key Enable/Disable.....	35/62
[190] No Activity Arming Pre-Alert Timer.....	24/51	[201]-[204] Wireless Keypad Serial Number.....	36/62
[191] No Activity Arming Timer.....	24/51	[301]-[304] Wireless Siren Serial Number.....	36/62
[202]-[209] Zone Assignments.....	24/51	[311]-[314] Wireless Siren Options.....	36/62
[301] First Telephone Number.....	24/51	[320] Global Siren Options.....	37/63
[302] Second Telephone Number.....	24/51	[330] Maximum Outdoor Siren Activation Timer.....	37/63
[303] Third Telephone Number.....	24/51	[401]-[404] Wireless Repeater Programming.....	37/63
[304] Call Waiting Cancel String.....	24/51	[900] General Wireless Options.....	37/63
[305] Fourth Telephone Number.....	24/51	[850] Cellular Signal Strength.....	37/64
[310] System Account Code.....	24/51	[851] Alt. Comm. Module Programming.....	37/64
[320]-[323] Alarm Rep. Codes.....	25/52	[898] Wireless Device Enrollment.....	38/64
[324]-[327] Alarm/Restore Rep. Codes.....	25/52	[899] Template Programming.....	38/64
[328] Misc. Alarm Rep. Codes.....	25/52	[900] Panel Version.....	38/64
[329] Priority Alarm/Restore Rep. Codes.....	26/52	[904]-[907] Wireless Device Placement Test.....	38/64
[330]-[333] Tamper Rep. Codes.....	26/52	[908] Wireless Modules.....	38/64
[334]-[337] Tamper Restore Rep. Codes.....	26/52	[990] Installer Lockout Enable.....	38/64
[338] Misc. Tamper Rep Codes.....	26/52	[991] Installer Lockout Disable.....	38/64
[339] Closing (Arming) Rep. Codes.....	26/52	[992] Alt. Comm/Ethernet Module Label Broadcast.....	38/64
[341] Misc. Closing (Arming) Rep. Codes.....	27/52	[996] Restore Wireless Device Default Programming.....	38/64
[342] Opening (Disarming) Rep. Codes.....	27/53	[998] Restore Panel Default Programming.....	38/64
[344] Misc. Opening (Disarming) Rep. Codes.....	27/53	[999] Restore Factory Default Programming.....	38/64
[345] Maintenance Alarm Rep. Codes.....	27/53	Local Keypad Programming.....	39/64
[346] Maintenance Restore Rep. Codes.....	27/53	[000] Keypad Function Key Programming.....	39/64
[347] Misc. Maintenance Rep. Codes.....	27/53	[001]-[064] Label Programming (Zone 1-64).....	39/66
[348] Test Transmission Rep. Codes.....	27/54	[065] Fire Alarm Label.....	41/67
[350] Communicator Format Options.....	27/54	[066] Fail to Arm Event Message.....	41/67
[351] Alarm/Rest. Comm. Call Directions.....	28/54	[067] Alarm When Armed Event Message.....	41/68
[359] Tamper/Rest. Comm. Call Directions.....	28/54	[074] First Keypad Options.....	41/68
[367] Opening/Closing Comm. Call Directions.....	28/54	[075] Second Keypad Options.....	41/68
[375] System Maint. Comm. Call Directions.....	28/54	[076] Third Keypad Options.....	41/69
[376] System Test Trans. Comm. Call Directions.....	28/54	[077] Programmed LCD Message.....	41/69
[377] Communication Variables.....	28/55	[078] Programmed LCD Message Duration.....	42/69
[378] Test Transmission Time of Day.....	28/55	[100] CO Detector Alarm Label.....	42/69
[380] First Communicator Options.....	29/55	[101] System Label.....	42/69
[381] Second Communicator Options.....	29/56	[120]-[121] Command Output Labels.....	42/69
[382] Third Communicator Options.....	29/56	[996] Reset Programmable Labels to Factory Defaults.....	42/69
[383] Fourth Communicator Options.....	30/56	[997] Keypad Version.....	42/69
[389] Alt. Comm. Fault Check Timer.....	30/57	[998] Initiate Global Label Broadcast.....	42/69
[401] Downloading Options.....	30/57	[999] Reset All Keypad Programming To Factory Defaults.....	42/69
[402] DLS Downloading Computer's Phone Number.....	30/58		
[403] DLS Downloading Access Code.....	30/58		



### 5.3 Programming Worksheets

**i** Unless indicated otherwise, default values apply to NA and CP-01.  
**i** SIA FAR CP-01 defaults are indicated in gray. e.g., ✓ or 030

#### [001]-[004] Zone Definitions

- |                                    |  |   |
|------------------------------------|--|---|
| 00 Null Zone (Not Used)            | 14 24 Hour Heat*                         | 27-30 Future Use                          |
| 01 Delay 1*                        | 15 24 Hour Medical*                      | 31 Day Zone                               |
| 02 Delay 2*                        | 16 24 Hour Panic*                        | 32 Instant Stay/Away*                     |
| 03 Instant*                        | 17 24 Hour Emergency*                    | 33 Future Use                             |
| 04 Interior*                       | 18 Future Use                            | 34 Future Use                             |
| 05 Interior, Stay/Away*            | 19 24 Hour Water*                        | 35 Future Use                             |
| 06 Delay, Stay/Away*               | 20 24 Hour Freeze*                       | 36 24 Hr. Non-Latching Tamper             |
| 07-08 Future Use                   | 21 Future Use                            | 37 Night Zone*                            |
| 09 24 Hour Supervisory (Hardwired) | 22 Momentary Keyswitch Arm*              | 81 24-Hour Carbon Monoxide (Wireless)**   |
| 10 24 Hour Supervisory Buzzer*     | 23 Maintained Keyswitch Arm (Hardwired)* | 82 Future Use                             |
| 11 24 Hour Burglary*               | 24 Future Use                            | 87 Delayed 24 Hr. Fire (Wireless)**       |
| 12 Future Use                      | 25 Interior Delay*                       | 88 Standard 24 Hr. Fire (Wireless)**      |
| 13 24 Hour Gas*                    | 26 24-hour Non-Alarm (Local Alarm)       | 89 Auto-verified 24 Hr. Fire (Wireless)** |
- \*For burglary applications only      \*\* For residential fire applications only

Section	Zone	Default	Section	Zone	Default	Section	Zone	Default	Section	Zone	Default
[001]	01	01	[001]	09	00	[002]	17	00	[002]	25	00
	02	03		10	00		18	00		26	00
	03	03		11	00		19	00		27	00
	04	03		12	00		20	00		28	00
	05	04		13	00		21	00		29	00
	06	04		14	00		22	00		30	00
	07	04		15	00		23	00		31	00
	08	04		16	00		24	00		32	00

Section	Zone	Default	Section	Zone	Default	Section	Zone	Default	Section	Zone	Default
[003]	33	00	[003]	41	00	[004]	49	00	[004]	57	00
	34	00		42	00		50	00		58	00
	35	00		43	00		51	00		59	00
	36	00		44	00		52	00		60	00
	37	00		45	00		53	00		61	00
	38	00		46	00		54	00		62	00
	39	00		47	00		55	00		63	00
	40	00		48	00		56	00		64	00

#### [005] System Timers

Valid entries for Entry Delay are between 030-255. Valid entries for SIA CP-01 Exit Delay is between 045-255.

Sub Sect.	Entry Delay	Exit Delay	Default
[01]	Entry Delay 1	030	_____
	Entry Delay 2	045 030	_____
	Exit Delay	120 060	_____
[09]	Bell Time-out (BTO)	004	_____ Enter 3 digits from 001-255 (minutes)

**i** If the Exit Delay is silent (section 14, option 6 or Stay Function Key Arming), the exit delay is twice the programmed value but will not exceed 255 seconds (090-255 seconds).

**i** For UL installations, the Entry Delay plus the Communications Delay must not exceed 60 seconds.

#### [006] Installer Code

Default  
555555 \_\_\_\_\_

#### [007] Master Code

Default  
123456 \_\_\_\_\_

#### [008] Maintenance Code

Default  
AAAA00 \_\_\_\_\_

**i** These codes are 4 or 6-digits (programmed in section [701] Opt.[5]. For 4-digit codes, the default is the first 4 digits.

**Programmable Output Options**

- 00 Null PGM (Not Used)
- 01 Residential Burglary and Fire Bell Output
- 02-04 Future Use
- 05 System Armed Status
- 06 Ready To Arm
- 07 Keypad Buzzer Follower
- 08 Courtesy Pulse
- 09 System Trouble Output (with Trouble Options)

- 10 System Event Output (with Event Options)
- 11 System Tamper (all sources: zones, keypad)
- 12 TLM and Alarm
- 13-16 Future Use
- 17 Away Armed Status
- 18 Stay Armed Status
- 19 Command Output #1 ([\*][7][1])
- 20 Command Output #2 ([\*][7][2])
- 21-40 Future Use

**[009] PGM Programming**

**Default**

- 00  PGM 1 Enter PGM Definition
- 00  PGM 2 Enter PGM Definition

**[012] Keypad Lockout Options**

**Default**

- 000  Number of Invalid Codes Before Lockout (Valid entries are 000-255)
- 000  Lockout Duration (in minutes) (Valid entries are 000-255)

! If Keypad Lockout is active, the panel cannot be disarmed with a keyswitch.

**[013] First System Options**

- | Opt | Def. | ON  | OFF  |
|-----|------|---|--|
| 1   | ✓    | <input type="checkbox"/> Hardwired Zone 33 Input Enabled    | <input type="checkbox"/> PGM1 Output Enabled           |
| 2   | ✓    | <input type="checkbox"/> Hardwired Zone 34 Input Enabled    | <input type="checkbox"/> PGM2 Output Enabled           |
| 3-5 |      | <input type="checkbox"/> Future Use                         |  |
| 6   |      | <input type="checkbox"/> Audible Exit Fault Enabled         | ✓ <input type="checkbox"/> Audible Exit Fault Disabled |
| 7   |      | <input type="checkbox"/> Future Use                         |  |
| 8   |      | <input type="checkbox"/> Temporal Three Fire Signal Enabled | ✓ <input type="checkbox"/> Standard Pulsed Fire Signal |

**[014] Second System Options**

- | Opt | Def. | ON  | OFF   |
|-----|------|---|---|
| 1   |      | <input type="checkbox"/> Arm/Disarm Squawk Enabled  | ✓ <input type="checkbox"/> Arm/Disarm Squawk Disabled     |
| 2   |      | <input type="checkbox"/> Future Use                 |   |
| 3   |      | <input type="checkbox"/> RF Jam Log After 5 Minutes | ✓ <input type="checkbox"/> RF Jam Logs After 20 seconds   |
| 4   |      | <input type="checkbox"/> Aux Boost Enabled          | ✓ <input type="checkbox"/> Aux Boost Disabled             |
| 5   |      | <input type="checkbox"/> Future Use                 |   |
| 6   | ✓    | <input type="checkbox"/> Audible Exit With Urgency  | <input type="checkbox"/> Silent Exit Delay                |
| 7   |      | <input type="checkbox"/> Future Use                 |   |
| 8   |      | <input type="checkbox"/> Fire Bell is Continuous    | ✓ <input type="checkbox"/> Fire Bell Follows Bell Cut-off |

**[015] Third System Options**

- | Opt | Def. | ON   | OFF   |
|-----|------|--|---|
| 1   | ✓    | <input type="checkbox"/> [F] Key Enabled                                 | <input type="checkbox"/> [F] Key Disabled                                   |
| 2   |      | <input type="checkbox"/> [P] Key Audible (Siren/Beeps)                   | ✓ <input type="checkbox"/> [P] Key Silent                                   |
| 3   | ✓    | <input type="checkbox"/> Quick Exit Enabled                              | <input type="checkbox"/> Quick Exit Disabled                                |
| 4   | ✓    | <input type="checkbox"/> Quick Arming Enabled ([*][0] and Function Keys) | <input type="checkbox"/> Quick Arming Disabled (Function Key Requires Code) |
| 5   |      | <input type="checkbox"/> Code Required for Bypassing                     | ✓ <input type="checkbox"/> No Code Required                                 |
| 6   |      | <input type="checkbox"/> Master Code Not Changeable                      | ✓ <input type="checkbox"/> Master Code Changeable                           |
| 7   | ✓    | <input type="checkbox"/> TLM Enabled                                     | <input type="checkbox"/> TLM Disabled                                       |
| 8   |      | <input type="checkbox"/> System Tamper Enabled                           | ✓ <input type="checkbox"/> System Tamper Disabled                           |

**[016] Fourth System Options**

Opt	Def.	ON	OFF
1		<input type="checkbox"/> Cross Zoning Enabled	<input checked="" type="checkbox"/> <input type="checkbox"/> Police Code Enabled
2	<input checked="" type="checkbox"/>	<input type="checkbox"/> Exit Delay Restart Enabled	<input checked="" type="checkbox"/> <input type="checkbox"/> Exit Delay Restart Disabled
3		<input type="checkbox"/> Blank Keypad When Not Used	<input checked="" type="checkbox"/> <input type="checkbox"/> Keypad Always Active
4		<input type="checkbox"/> Code Required to Remove Keypad Blanking	<input checked="" type="checkbox"/> <input type="checkbox"/> No Code Required
5	<input checked="" type="checkbox"/>	<input type="checkbox"/> Keypad Backlighting Enabled	<input type="checkbox"/> Keypad Backlighting Disabled
6		<input type="checkbox"/> Future Use	
7		<input type="checkbox"/> Bypass Status Displayed While Armed	<input checked="" type="checkbox"/> <input type="checkbox"/> Bypass Status Not Displayed While Armed
8		<input type="checkbox"/> Daylight Saving Time Enabled	<input checked="" type="checkbox"/> <input type="checkbox"/> Daylight Saving Time Disabled

**[018] Sixth System Options**

Opt	Def.	ON	OFF
1		<input type="checkbox"/> Future Use	
2		<input type="checkbox"/> Keypad Tamper Enabled	<input checked="" type="checkbox"/> <input type="checkbox"/> Keypad Tamper Disabled
3-4		<input type="checkbox"/> Future Use	
5		<input type="checkbox"/> Keypad Buzzer Follows Siren Enabled	<input checked="" type="checkbox"/> <input type="checkbox"/> Keypad Buzzer Follows Siren Disabled
6-8		<input type="checkbox"/> Future Use	

**[023] Tenth System Options**

Opt	Def.	ON	OFF
1	<input checked="" type="checkbox"/>	<input type="checkbox"/> Chime On Openings Enabled	<input type="checkbox"/> Chime On Openings Disabled
2	<input checked="" type="checkbox"/>	<input type="checkbox"/> Chime On Closings Enabled	<input type="checkbox"/> Chime On Closings Disabled
3		<input type="checkbox"/> Test Transmission While Armed Only	<input checked="" type="checkbox"/> <input type="checkbox"/> Test Transmission while Armed/Disarmed
4		<input type="checkbox"/> Test Transmission Counter In Hours	<input checked="" type="checkbox"/> <input type="checkbox"/> Test Transmission Counter In Days
5		<input type="checkbox"/> Switching from Away to Stay Disabled	<input checked="" type="checkbox"/> <input type="checkbox"/> Away to Stay Toggle Option Permitted
6	<input checked="" type="checkbox"/>	<input type="checkbox"/> New Alarms will not Disconnect 2-Way Audio	<input type="checkbox"/> New Alarms Disconnect 2-Way Audio
7		<input type="checkbox"/> Trouble Beeps are Silent	<input checked="" type="checkbox"/> <input type="checkbox"/> Trouble Beeps Sound Every 10 seconds
8		<input type="checkbox"/> Keyswitch Arms In Away Only	<input checked="" type="checkbox"/> <input type="checkbox"/> Keyswitch Arms In Stay or Away

**[024] Eleventh System Options**

Opt	Def.	ON	OFF
1	<input checked="" type="checkbox"/>	<input type="checkbox"/> Temperature Display Enabled	<input type="checkbox"/> Temperature Display Disabled
2	<input checked="" type="checkbox"/>	<input type="checkbox"/> Temperature Displayed in Celsius	<input checked="" type="checkbox"/> <input type="checkbox"/> Temperature Displayed In Fahrenheit
3	<input checked="" type="checkbox"/>	<input type="checkbox"/> Internal Siren Enabled	<input type="checkbox"/> Internal Siren Disabled
4	<input checked="" type="checkbox"/>	<input type="checkbox"/> Inactivity Monitored By All Zones	<input type="checkbox"/> Inactivity Monitored Only By 24 Hr Non-Alarm Zones
5		<input type="checkbox"/> Enable Realtime Clock	<input checked="" type="checkbox"/> <input type="checkbox"/> Disable Realtime Clock
6-8		<input type="checkbox"/> Future Use	

**[030] Zone Loop Response Options**

Opt	Def.	ON	OFF
1		<input type="checkbox"/> Zone 33 is Fast Loop Response	<input checked="" type="checkbox"/> <input type="checkbox"/> Zone 33 is Normal Loop Response
2		<input type="checkbox"/> Zone 34 is Fast Loop Response	<input checked="" type="checkbox"/> <input type="checkbox"/> Zone 34 is Normal Loop Response

**[101]-[164] Zone Attributes**

Options 9 and 10 do not apply to SCW9055 versions. Options 14, 15 and 16 apply to hardwired zones only (zones 33 & 34) when used as hardwired zones. To program attributes 9 to 16, press 9 within the zone attribute section. Press 9 again to program attributes 1 to 8.

**Zone Attribute Defaults**

Attribute:	1	2	3	4	5	6	7	8	9	10	14	15	16
	✓ =ON Zone Type: OFF												
	Audible	Steady	Chime	Bypass	Force	Swing	Tx. Delay	Cross Zn	2-way Audio	Talk-Listen	NC	SEOL	DEOL
00 Null Zone													
01 Delay 1	✓	✓	✓	✓		✓	✓		✓	✓		✓	
02 Delay 2	✓	✓	✓	✓		✓	✓		✓	✓		✓	
03 Instant	✓	✓	✓	✓		✓	✓		✓	✓		✓	
04 Interior	✓	✓		✓		✓	✓		✓	✓		✓	
05 Interior Stay/Away	✓	✓		✓	✓	✓	✓		✓	✓		✓	
06 Delay Stay/Away	✓	✓		✓	✓	✓	✓		✓	✓		✓	
07-08 Future Use													
09 24-hr. Superv. (Hardwired)		✓			✓	✓	✓					✓	
10 24-hr. Superv. Buzzer		✓		✓			✓		✓	✓		✓	
11 24-hr. Burglary	✓	✓		✓		✓	✓		✓	✓		✓	
12 Future Use													
13 24-hr. Gas	✓					✓	✓		✓	✓		✓	
14 24-hr. Heat	✓					✓	✓					✓	
15 24-hr. Medical	✓	✓				✓	✓		✓	✓		✓	
16 24-hr. Panic	✓	✓				✓	✓		✓	✓		✓	
17 24-hr. Emergency	✓	✓				✓	✓		✓	✓		✓	
18 Future Use													
19 24-hr. Water	✓	✓				✓	✓		✓	✓		✓	
20 24-hr. Freeze	✓	✓				✓	✓		✓	✓		✓	
21 Future Use													
22 Momentary Keyswitch Arm					✓							✓	
23 Maintained Keyswitch Arm					✓							✓	
24 Future Use													
25 Interior Delay	✓	✓		✓		✓	✓		✓	✓		✓	
26 24-hr. Non-Alarm (local alarm)					✓							✓	
27-30 Future Use													
31 Day Zone	✓	✓		✓	✓	✓	✓		✓	✓		✓	
32 Instant Stay/Away	✓	✓		✓		✓	✓		✓	✓		✓	
33-34 Future Use													
35 Future Use													
36 24-hr. Non-Latching Tamper		✓				✓	✓					✓	
37 Night Zone	✓	✓		✓	✓	✓	✓		✓	✓		✓	
81 24-hr. Carbon Monoxide (Wireless)	✓												
87 Delay 24-hr. Fire (Wireless)	✓												
88 Standard 24-hr. Fire (Wireless)	✓												
89 Auto-Verified Fire (Wireless)	✓												

\* For UL installations, do not change attribute 5 (Force Arming) from the default setting. For CP-01 installations: Option 6 (Swinger) is defaulted ON for zone definitions 09-11, 13-17, 19, 20. Option 7 (Tx Delay) is defaulted ON for zone definitions 01-06, 09-11, 13-17, 19, 20, 25, 32, 36, 37.

**[167] Alt. Comm. Communications Wait For Ack**

Default 060  Valid entries are 060-255 seconds

**[168] Daylight Saving Time Begin**

Default

- 003 Month  Valid Entries 001-012
- 002 Week  Valid Entries 000-005
- 000 Day  Valid Entries 000-031
- 002 Hour  Valid Entries 000-023
- 001 Increment  Valid Entries 001-002

**[169] Daylight Saving Time End**

Default

- 011 Month  Valid Entries 001-012
- 001 Week  Valid Entries 000-005
- 000 Day  Valid Entries 000-031
- 002 Hour  Valid Entries 000-023
- 001 Decrement  Valid Entries 001-002

**[170] PGM Output Timer**

Default 005

Valid entries are 001-255 seconds

**[176] Cross Zone/Police Code Timer**Default 060 

Valid entries are 001-255 seconds/minutes

**[190] No Activity Arming Pre-alert Timer**Default 001  **Note:** Not CP-01 compliant

Valid entries are 001-255 minutes, 000 for no pre-alert

**[191] No Activity Arming Timer**Default 000  **Note:** Not CP-01 compliant

Valid entries are 001-255 minutes, 000 to disable

**[202] - [209] Zone Assignments**

	<b>[202] Zone 1-8</b>	<b>[203] Zones 9-16</b>	<b>[204] Zones 17-24</b>	<b>[205] Zones 25-32</b>	<b>[206] Zones 33-40</b>
<b>Opt</b>	<b>Def.</b>	<b>Def.</b>	<b>Def.</b>	<b>Def.</b>	<b>Def.</b>
1	<input checked="" type="checkbox"/> <input type="checkbox"/> Zone 1	<input type="checkbox"/> Zone 9	<input type="checkbox"/> Zone 17	<input type="checkbox"/> Zone 25	<input type="checkbox"/> Zone 33
2	<input checked="" type="checkbox"/> <input type="checkbox"/> Zone 2	<input type="checkbox"/> Zone 10	<input type="checkbox"/> Zone 18	<input type="checkbox"/> Zone 26	<input type="checkbox"/> Zone 34
3	<input checked="" type="checkbox"/> <input type="checkbox"/> Zone 3	<input type="checkbox"/> Zone 11	<input type="checkbox"/> Zone 19	<input type="checkbox"/> Zone 27	<input type="checkbox"/> Zone 35
4	<input checked="" type="checkbox"/> <input type="checkbox"/> Zone 4	<input type="checkbox"/> Zone 12	<input type="checkbox"/> Zone 20	<input type="checkbox"/> Zone 28	<input type="checkbox"/> Zone 36
5	<input checked="" type="checkbox"/> <input type="checkbox"/> Zone 5	<input type="checkbox"/> Zone 13	<input type="checkbox"/> Zone 21	<input type="checkbox"/> Zone 29	<input type="checkbox"/> Zone 37
6	<input checked="" type="checkbox"/> <input type="checkbox"/> Zone 6	<input type="checkbox"/> Zone 14	<input type="checkbox"/> Zone 22	<input type="checkbox"/> Zone 30	<input type="checkbox"/> Zone 38
7	<input checked="" type="checkbox"/> <input type="checkbox"/> Zone 7	<input type="checkbox"/> Zone 15	<input type="checkbox"/> Zone 23	<input type="checkbox"/> Zone 31	<input type="checkbox"/> Zone 39
8	<input checked="" type="checkbox"/> <input type="checkbox"/> Zone 8	<input type="checkbox"/> Zone 16	<input type="checkbox"/> Zone 24	<input type="checkbox"/> Zone 32	<input type="checkbox"/> Zone 40
	<b>[207] Zone 41-48</b>	<b>[208] Zones 49-56</b>	<b>[209] Zones 57-64</b>		
<b>Opt</b>	<b>Def.</b>	<b>Def.</b>	<b>Def.</b>		
1	<input type="checkbox"/> Zone 41	<input type="checkbox"/> Zone 49	<input type="checkbox"/> Zone 57		
2	<input type="checkbox"/> Zone 42	<input type="checkbox"/> Zone 50	<input type="checkbox"/> Zone 58		
3	<input type="checkbox"/> Zone 43	<input type="checkbox"/> Zone 51	<input type="checkbox"/> Zone 59		
4	<input type="checkbox"/> Zone 44	<input type="checkbox"/> Zone 52	<input type="checkbox"/> Zone 60		
5	<input type="checkbox"/> Zone 45	<input type="checkbox"/> Zone 53	<input type="checkbox"/> Zone 61		
6	<input type="checkbox"/> Zone 46	<input type="checkbox"/> Zone 54	<input type="checkbox"/> Zone 62		
7	<input type="checkbox"/> Zone 47	<input type="checkbox"/> Zone 55	<input type="checkbox"/> Zone 63		
8	<input type="checkbox"/> Zone 48	<input type="checkbox"/> Zone 56	<input type="checkbox"/> Zone 64		

**Communications****[301] First Telephone Number (32 Digits)**D **[302] Second Telephone Number (32 Digits)**D **[303] Third Telephone Number (32 Digits)**D **[304] Call Waiting Cancel String (6 Digits)** - This feature is activated in Section 382 Opt 4 Default = DB70EF Program unused digits with Hex F

**i** All six digits must be entered for changes to be saved in Section [304] and Section [310]. Fill unused digit spaces with "F."

**[305] Fourth Telephone Number (32 Digits)**D **[310] System Account Code**

Enter a 4 or 6-digit account number for the system account code. Only SIA supports 6-digit account codes. If a 4-digit code is used, program the last two digits of the account code with FF.

Default = FFFFFFF

## Reporting Codes

**i** All Reporting Codes are defaulted "FF" unless indicated otherwise.

### [320]-[323] Alarm Reporting Codes, Zones 01-64

Section Default: FF

<b>[320]</b>	Zone 01	Zone 02	Zone 03	Zone 04	Zone 05	Zone 06	Zone 07	Zone 08
	<input type="text"/>	<input type="text"/>	<input type="text"/>	<input type="text"/>	<input type="text"/>	<input type="text"/>	<input type="text"/>	<input type="text"/>
	Zone 09	Zone 10	Zone 11	Zone 12	Zone 13	Zone 14	Zone 15	Zone 16
<b>[321]</b>	<input type="text"/>	<input type="text"/>	<input type="text"/>	<input type="text"/>	<input type="text"/>	<input type="text"/>	<input type="text"/>	<input type="text"/>
	Zone 17	Zone 18	Zone 19	Zone 20	Zone 21	Zone 22	Zone 23	Zone 24
	<input type="text"/>	<input type="text"/>	<input type="text"/>	<input type="text"/>	<input type="text"/>	<input type="text"/>	<input type="text"/>	<input type="text"/>
<b>[322]</b>	Zone 25	Zone 26	Zone 27	Zone 28	Zone 29	Zone 30	Zone 31	Zone 32
	<input type="text"/>	<input type="text"/>	<input type="text"/>	<input type="text"/>	<input type="text"/>	<input type="text"/>	<input type="text"/>	<input type="text"/>
	Zone 33	Zone 34	Zone 35	Zone 36	Zone 37	Zone 38	Zone 39	Zone 40
<b>[323]</b>	<input type="text"/>	<input type="text"/>	<input type="text"/>	<input type="text"/>	<input type="text"/>	<input type="text"/>	<input type="text"/>	<input type="text"/>
	Zone 41	Zone 42	Zone 43	Zone 44	Zone 45	Zone 46	Zone 47	Zone 48
	<input type="text"/>	<input type="text"/>	<input type="text"/>	<input type="text"/>	<input type="text"/>	<input type="text"/>	<input type="text"/>	<input type="text"/>
<b>[323]</b>	Zone 49	Zone 50	Zone 51	Zone 52	Zone 53	Zone 54	Zone 55	Zone 56
	<input type="text"/>	<input type="text"/>	<input type="text"/>	<input type="text"/>	<input type="text"/>	<input type="text"/>	<input type="text"/>	<input type="text"/>
	Zone 57	Zone 58	Zone 59	Zone 60	Zone 61	Zone 62	Zone 63	Zone 64
<input type="text"/>	<input type="text"/>	<input type="text"/>	<input type="text"/>	<input type="text"/>	<input type="text"/>	<input type="text"/>	<input type="text"/>	

### [324]-[327] Alarm Restore Reporting Codes, Zones 01-64

Section Default: FF

<b>[324]</b>	Zone 01	Zone 02	Zone 03	Zone 04	Zone 05	Zone 06	Zone 07	Zone 08
	<input type="text"/>	<input type="text"/>	<input type="text"/>	<input type="text"/>	<input type="text"/>	<input type="text"/>	<input type="text"/>	<input type="text"/>
	Zone 09	Zone 10	Zone 11	Zone 12	Zone 13	Zone 14	Zone 15	Zone 16
<b>[325]</b>	<input type="text"/>	<input type="text"/>	<input type="text"/>	<input type="text"/>	<input type="text"/>	<input type="text"/>	<input type="text"/>	<input type="text"/>
	Zone 17	Zone 18	Zone 19	Zone 20	Zone 21	Zone 22	Zone 23	Zone 24
	<input type="text"/>	<input type="text"/>	<input type="text"/>	<input type="text"/>	<input type="text"/>	<input type="text"/>	<input type="text"/>	<input type="text"/>
<b>[326]</b>	Zone 25	Zone 26	Zone 27	Zone 28	Zone 29	Zone 30	Zone 31	Zone 32
	<input type="text"/>	<input type="text"/>	<input type="text"/>	<input type="text"/>	<input type="text"/>	<input type="text"/>	<input type="text"/>	<input type="text"/>
	Zone 33	Zone 34	Zone 35	Zone 36	Zone 37	Zone 38	Zone 39	Zone 40
<b>[327]</b>	<input type="text"/>	<input type="text"/>	<input type="text"/>	<input type="text"/>	<input type="text"/>	<input type="text"/>	<input type="text"/>	<input type="text"/>
	Zone 41	Zone 42	Zone 43	Zone 44	Zone 45	Zone 46	Zone 47	Zone 48
	<input type="text"/>	<input type="text"/>	<input type="text"/>	<input type="text"/>	<input type="text"/>	<input type="text"/>	<input type="text"/>	<input type="text"/>
<b>[327]</b>	Zone 49	Zone 50	Zone 51	Zone 52	Zone 53	Zone 54	Zone 55	Zone 56
	<input type="text"/>	<input type="text"/>	<input type="text"/>	<input type="text"/>	<input type="text"/>	<input type="text"/>	<input type="text"/>	<input type="text"/>
	Zone 57	Zone 58	Zone 59	Zone 60	Zone 61	Zone 62	Zone 63	Zone 64
<input type="text"/>	<input type="text"/>	<input type="text"/>	<input type="text"/>	<input type="text"/>	<input type="text"/>	<input type="text"/>	<input type="text"/>	

### [328] Miscellaneous Alarm Reporting Codes

- Duress Alarm
- Opening After Alarm
- Recent Closing
- Future Use
- Future Use
- Cross Zone/Police Code Alarm
- Burglary Not Verified
- Alarm Cancelled

**[329] Priority Alarm and Restore Reporting Codes**

	Keypad [F] Fire Alarm
	Keypad [A] Auxiliary Alarm
	Keypad [P] Panic Alarm
	Fail to Report In
	Keypad [F] Fire Restore
	Keypad [A] Auxiliary Restore
	Keypad [P] Panic Restore
	Future Use

**[330]-[333] Tamper Reporting Codes, Zones 01-64**

Section Default: FF

<b>[330]</b>	Zone 01	Zone 02	Zone 03	Zone 04	Zone 05	Zone 06	Zone 07	Zone 08
	Zone 09	Zone 10	Zone 11	Zone 12	Zone 13	Zone 14	Zone 15	Zone 16
<b>[331]</b>	Zone 17	Zone 18	Zone 19	Zone 20	Zone 21	Zone 22	Zone 23	Zone 24
	Zone 25	Zone 26	Zone 27	Zone 28	Zone 29	Zone 30	Zone 31	Zone 32
<b>[332]</b>	Zone 33	Zone 34	Zone 35	Zone 36	Zone 37	Zone 38	Zone 39	Zone 40
	Zone 41	Zone 42	Zone 43	Zone 44	Zone 45	Zone 46	Zone 47	Zone 48
<b>[333]</b>	Zone 49	Zone 50	Zone 51	Zone 52	Zone 53	Zone 54	Zone 55	Zone 56
	Zone 57	Zone 58	Zone 59	Zone 60	Zone 61	Zone 62	Zone 63	Zone 64

**[334]-[337] Tamper Restore Reporting Codes, Zones 01-64**

Section Default: FF

<b>[334]</b>	Zone 01	Zone 02	Zone 03	Zone 04	Zone 05	Zone 06	Zone 07	Zone 08
	Zone 09	Zone 10	Zone 11	Zone 12	Zone 13	Zone 14	Zone 15	Zone 16
<b>[335]</b>	Zone 17	Zone 18	Zone 19	Zone 20	Zone 21	Zone 22	Zone 23	Zone 24
	Zone 25	Zone 26	Zone 27	Zone 28	Zone 29	Zone 30	Zone 31	Zone 32
<b>[336]</b>	Zone 33	Zone 34	Zone 35	Zone 36	Zone 37	Zone 38	Zone 39	Zone 40
	Zone 41	Zone 42	Zone 43	Zone 44	Zone 45	Zone 46	Zone 47	Zone 48
<b>[337]</b>	Zone 49	Zone 50	Zone 51	Zone 52	Zone 53	Zone 54	Zone 55	Zone 56
	Zone 57	Zone 58	Zone 59	Zone 60	Zone 61	Zone 62	Zone 63	Zone 64

**[338] Miscellaneous Tamper Reporting Codes**

	General System Tamper
	General System Tamper Restore
	Keypad Lockout

**[339] Closing (Arming) Reporting Codes, Access Codes 1-16**

Section

<b>[339]</b>	Code 1	Code 2	Code 3	Code 4	Code 5	Code 6	Code 7	Code 8
	Code 9	Code 10	Code 11	Code 12	Code 13	Code 14	Code 15	Code 16

**[341] Miscellaneous Closing (Arming) Reporting Codes**

- |\_|\_| Closing by Master Code 40
- |\_|\_| Automatic Zone Bypass
- |\_|\_| Partial Closing
- |\_|\_| Special Closing
- |\_|\_| Exit Fault

**[342] Opening (Disarming) Reporting Codes, Access Codes 1-16**

- |        |         |         |         |         |         |         |         |
|--------|---------|---------|---------|---------|---------|---------|---------|
| Code 1 | Code 2  | Code 3  | Code 4  | Code 5  | Code 6  | Code 7  | Code 8  |
| _ _    | _ _     | _ _     | _ _     | _ _     | _ _     | _ _     | _ _     |
| Code 9 | Code 10 | Code 11 | Code 12 | Code 13 | Code 14 | Code 15 | Code 16 |
| _ _    | _ _     | _ _     | _ _     | _ _     | _ _     | _ _     | _ _     |

**[344] Miscellaneous Opening (Disarming) Reporting Codes**

- |\_|\_| Opening by Master Code 40
- |\_|\_| Special Opening
- |\_|\_| Late to Open

**[345] Maintenance Alarm Reporting Codes**

- |\_|\_| Battery Trouble Alarm
- |\_|\_| AC Failure Trouble Alarm
- |\_|\_| Future Use
- |\_|\_| Fire Trouble Alarm
- |\_|\_| Auxiliary Power Supply Trouble Alarm
- |\_0\_|\_0\_| TLM Alarm
- |\_|\_| General System Trouble
- |\_|\_| General System Supervisory Trouble

**[346] Maintenance Restore Reporting Codes**

- |\_|\_| Battery Trouble Restore
- |\_|\_| AC Failure Trouble Restore
- |\_|\_| Future Use
- |\_|\_| Fire Trouble Restore
- |\_|\_| Auxiliary Power Supply Trouble Restore
- |\_|\_| TLM Restore
- |\_|\_| General System Trouble Restore
- |\_|\_| General System Supervisory Restore
- |\_0\_|\_0\_| System Reset (Cold Start)

**[347] Miscellaneous Maintenance Reporting Codes**

- |\_|\_| Telephone Number 1 FTC Restore
- |\_|\_| Telephone Number 2 FTC Restore
- |\_|\_| Future Use
- |\_0\_|\_0\_| DLS Lead IN
- |\_0\_|\_0\_| DLS Lead OUT
- |\_|\_| General Zone Fault Alarm
- |\_|\_| General Zone Fault Restore
- |\_|\_| Delinquency Reporting Code
- |\_|\_| General Zone Low Battery Alarm
- |\_|\_| General Zone Low Battery Restore
- |\_0\_|\_0\_| Installer Lead Out
- |\_0\_|\_0\_| Installer Lead In
- |\_|\_| Telephone number 3 FTC Restore
- |\_|\_| Telephone number 4 FTC Restore
- |\_|\_| Panel Firmware Update Begin
- |\_|\_| Panel Firmware Update Successful

**[348] Test Transmission Reporting Codes**

- |\_|\_| Walk Test End
- |\_|\_| Walk Test Begin
- |\_|\_| Future Use
- |\_|\_| Periodic Test Transmission
- |\_|\_| System Test

**[350] Communicator Format Options**

1st Telephone Number	2nd Telephone Number	3rd Telephone Number	4th Telephone Number
Default 04  _ _	Default 04  _ _	Default 04  _ _	Default 04  _ _

- |                    |                      |                    |            |
|--------------------|----------------------|--------------------|------------|
| 01 20 BPS, 1400 Hz | 02 20 BPS, 2300 Hz   | 03 DTMF Contact ID | 04 SIA FSK |
| 05 Future Use      | 06* Residential Dial |                    |            |

\*Failure to communicate using Residential Dial will not generate an FTC trouble. 3<sup>rd</sup> phone number follows the format of the 1<sup>st</sup> if configured for alternate dial.



**Call Direction Options****[351] Alarm/Restore Communicator Call Directions**

Option 1 First Telephone Number (Default ON)	Option 2 Second Telephone Number (Default OFF)	Option 3 Third Telephone Number (Default OFF)	Option 4 Fourth Telephone Number (Default OFF)	Option 5-8 Future Use (Default OFF)
✓	<input type="checkbox"/>	<input type="checkbox"/>	<input type="checkbox"/>	<input type="checkbox"/>

**[359] Tamper/Restore Communicator Call Directions**

Option 1 First Telephone Number (Default ON)	Option 2 Second Telephone Number (Default OFF)	Option 3 Third Telephone Number (Default OFF)	Option 4 Fourth Telephone Number (Default OFF)	Option 5-8 Future Use (Default OFF)
✓	<input type="checkbox"/>	<input type="checkbox"/>	<input type="checkbox"/>	<input type="checkbox"/>

**[367] Opening/Closing Communicator Call Directions**

Option 1 First Telephone Number (Default OFF)	Option 2 Second Telephone Number (Default OFF)	Option 3 Third Telephone Number (Default OFF)	Option 4 Fourth Telephone Number (Default OFF)	Option 5-8 Future Use (Default OFF)
<input type="checkbox"/>	<input type="checkbox"/>	<input type="checkbox"/>	<input type="checkbox"/>	<input type="checkbox"/>

**[375] System Maintenance Communicator Call Directions**

Option 1 First Telephone Number (Default ON)	Option 2 Second Telephone Number (Default OFF)	Option 3 Third Telephone Number (Default OFF)	Option 4 Fourth Telephone Number (Default OFF)	Option 5-8 Future Use (Default OFF)
✓	<input type="checkbox"/>	<input type="checkbox"/>	<input type="checkbox"/>	<input type="checkbox"/>

**[376] System Test Transmissions Communicator Call Directions**

Option 1 First Telephone Number (Default ON)	Option 2 Second Telephone Number (Default OFF)	Option 3 Third Telephone Number (Default OFF)	Option 4 Fourth Telephone Number (Default OFF)	Option 5-8 Future Use (Default OFF)
✓	<input type="checkbox"/>	<input type="checkbox"/>	<input type="checkbox"/>	<input type="checkbox"/>

**[377] Communication Variables**

Default

003 002	<u>  </u> <u>  </u> <u>  </u> <u>  </u>	Swinger Shutdown (Alarms and Rest)	001-014 Transmissions, 000=disabled
003	<u>  </u> <u>  </u> <u>  </u> <u>  </u>	Swinger Shutdown (Tampers and Rest)	001-014 Transmissions, 000=disabled
003	<u>  </u> <u>  </u> <u>  </u> <u>  </u>	Swinger Shutdown (Maint. and Rest)	001-014 Transmissions, 000=disabled
000 030	<u>  </u> <u>  </u> <u>  </u> <u>  </u>	Communication Delay	000-255 seconds, 000 = No Delay
030	<u>  </u> <u>  </u> <u>  </u> <u>  </u>	AC Failure Communication Delay	001-255 minutes/hours, 000=disabled†
010	<u>  </u> <u>  </u> <u>  </u> <u>  </u>	TLM Trouble Delay	003-255 seconds x3 (e.g., 003 = 9 seconds)
030	<u>  </u> <u>  </u> <u>  </u> <u>  </u>	Test Transmission Cycle (land line)	001-255 days/hours††
060	<u>  </u> <u>  </u> <u>  </u> <u>  </u>	Future Use	
007	<u>  </u> <u>  </u> <u>  </u> <u>  </u>	Wireless Device Low Battery Transmis- sion Delay	000-255 days
030	<u>  </u> <u>  </u> <u>  </u> <u>  </u>	Delinquency Transmission Delay	000-255 days/hours†††, 000=disabled
000 005	<u>  </u> <u>  </u> <u>  </u> <u>  </u>	Communications Cancelled Window	000-255 minutes

†Dependent on programming in section [382], option [6].

††Dependent on programming in section [023], option [4].

†††Dependent on programming in section [380], option [8].

**i** For UL installations, the Entry Delay plus Communication Delay time must not exceed 60 seconds.

**[378] Test Transmission Time of Day**

Default

9999                Valid entries are 0000-2359 (9999 to disable)

**[380] First Communicator Options**

<b>Opt</b>	<b>Def.</b>	<b>ON</b>	<b>OFF</b>
1	✓	<input type="checkbox"/> Communications Enabled	<input type="checkbox"/> Communications Disabled
2		<input type="checkbox"/> Restores on Siren Time-out	✓ <input type="checkbox"/> Restores Follow Zones
3		<input type="checkbox"/> Pulse Dialing	✓ <input type="checkbox"/> DTMF Dialing
4		<input type="checkbox"/> Future Use	
5		<input type="checkbox"/> Future Use	
6		<input type="checkbox"/> Alternating Backup Dialing Enabled	✓ <input type="checkbox"/> Call Primary Number, Backup to Secondary
7		<input type="checkbox"/> Future Use	
8		<input type="checkbox"/> Delinquency Follows Zone Activity (Hours)	✓ <input type="checkbox"/> Delinquency Follows Arming (Days)

**[381] Second Communicator Options**

<b>Opt</b>	<b>Def.</b>	<b>ON</b>	<b>OFF</b>
1		<input type="checkbox"/> Opening After Alarm Keypad Ringback Enabled	✓ <input type="checkbox"/> Opening After Alarm Ringback Disabled
2		<input type="checkbox"/> Future Use	
3		<input type="checkbox"/> SIA Uses Programmed Reporting Codes	✓ <input type="checkbox"/> SIA Uses Automatic Reporting Codes
4		<input type="checkbox"/> Closing Confirmation Enabled	✓ <input type="checkbox"/> Closing Confirmation Disabled
5		<input type="checkbox"/> Future Use	
6		<input type="checkbox"/> Future Use	
7		<input type="checkbox"/> Contact ID Uses Programmed Reporting Codes	✓ <input type="checkbox"/> Contact ID Uses Automatic Reporting Codes
8		<input type="checkbox"/> Future Use	

**[382] Third Communicator Options**

<b>Opt</b>	<b>Def.</b>	<b>ON</b>	<b>OFF</b>
1		<input type="checkbox"/> Future Use	
2		<input type="checkbox"/> Alarm Communications Enabled During Walk Test*	✓ <input type="checkbox"/> Alarm Communications Disabled During Walk Test
3	✓	<input type="checkbox"/> Communication Cancelled Message Enabled	✓ <input type="checkbox"/> Communication Cancelled Message Disabled
4		<input type="checkbox"/> Call Waiting Cancel Enabled**	✓ <input type="checkbox"/> Call Waiting Cancel Disabled
5		<input type="checkbox"/> Alt. Comm. Module Enabled (On for G/D/I models only)	✓ <input type="checkbox"/> Alt. Comm. Module Disabled
6		<input type="checkbox"/> AC Failure Transmission Delay Is In Hours	✓ <input type="checkbox"/> AC Failure Transmission Delay is in Minutes
7		<input type="checkbox"/> Number of Dialing Attempts is 1 for Residential Dial	✓ <input type="checkbox"/> Residential Dialing Attempts is 5
8		<input type="checkbox"/> Future Use	

\*This option must remain OFF for CP-01 installations.

\*\* A Call Waiting Cancel on a non-Call Waiting line will prevent successful connection to the central station.

**[383] Fourth Communicator Options**

Opt	Def.	ON	OFF
1		<input type="checkbox"/> Future Use	
2	✓	<input type="checkbox"/> Phone Number 2 Backs Up Number 1	<input type="checkbox"/> Phone Number 2 is Independent
3		<input type="checkbox"/> Phone Number 3 Backs Up Number 2	✓ <input type="checkbox"/> Phone Number 3 is Independent
4		<input type="checkbox"/> Phone Number 4 Backs Up Number 3	✓ <input type="checkbox"/> Phone Number 4 is Independent
5		<input type="checkbox"/> FTC'ed Events Communicate	✓ <input type="checkbox"/> FTC'ed Events Do Not Communicate
6	✓	<input type="checkbox"/> Account Code Error Check Enabled	<input type="checkbox"/> Account Code Error Check Disabled
7		<input type="checkbox"/> Future Use	
8		<input type="checkbox"/> Remote notification format is SIA	✓ <input type="checkbox"/> Remote notification format is CID

**[389] Alt. Comm. Fault Check Timer**

Def. 005    Valid entries are 003-255 x 3 (e.g., 003x3 = 9 seconds.)

**DLS Downloading****[401] First Downloading Options**

Opt	Def.	ON	OFF
1		<input type="checkbox"/> Answering Machine/Double Call Enabled	✓ <input type="checkbox"/> Answering Machine/Double Call Disabled
2	✓	<input type="checkbox"/> User Can Enable DLS Window	<input type="checkbox"/> User Cannot Enable DLS Window
3		<input type="checkbox"/> Call Back Enabled	✓ <input type="checkbox"/> Call Back Disabled
4		<input type="checkbox"/> User Initiated Call Up Enabled	✓ <input type="checkbox"/> User Initiated Call Up Disabled
5		<input type="checkbox"/> Future Use	
6		<input type="checkbox"/> 300 Baud Panel Call up	✓ <input type="checkbox"/> 110 Baud Panel Call up
7		<input type="checkbox"/> Future Use	
8	✓	<input type="checkbox"/> Alternate Communicator DLS Always	<input type="checkbox"/> Alternate Communicator Follows DLS Window

**[402] DLS Downloading Computer's Telephone Number (32 Digits)**

**D**

**[403] DLS Downloading Access Code / Panel ID Code (Enter 6 Hexadecimal Digits)**

Default = 905500 ; For SCW9057 = 905700

**[404] Panel ID Code (Enter 6 Hexadecimal Digits)**

Default = 905500 ; For SCW9057 = 905700

**[405] Double Call Timer**

Default 030

Valid entries are 001-255, (000 to disable)

**[406] Number of Rings To Answer On**

Default 000

Valid entries are 000-009, (000 to disable)

**[501]-[502] PGM Output Attributes**

Program only the following attributes for the PGM options listed. All others are ignored.

Attribute:	1	2	3	4	5	6	7	8
<b>PGM Option</b> ✓ = ON	Not Used	Not Used	True Output	Follows Timer	Code Req.	Not Used	Not Used	Not Used
<b>OFF</b>	-	-	Inverted	ON/OFF	No Code	No	No	No
00 Null PGM								
01 Burglary and Fire Siren Output			✓					
02-04 Future Use								
05 Armed Status			✓					
06 Ready To Arm			✓					
07 Keypad Buzzer Follow			✓					
08 Curtesy Pulse			✓					
09 System Trouble Output (with trouble options)	✓	✓	✓	✓	✓			
10 System Event (with event options)	✓	✓	✓	✓	✓			
11 System Tamper (all sources)			✓					
12 TLM and Alarm			✓					
13-16 Future Use								
17 Away Armed Status			✓					
18 Stay Armed Status			✓					
19 Command Output #1 (*71)			✓	✓	✓			
20 Command Output #2 (*72)			✓	✓				
21-39 Future Use								

Attribute:	1	2	3	4	5	6	7	8
<b>ON</b>	Service Req. Event	AC Fail	TLM Fault	FTC	Device Fault	Device Tamper	Device Low	Loss of Clock
<b>OFF</b>	Disabled	Disabled	Disabled	Disabled	Disabled	Disabled	Disabled	Disabled
09 System Trouble	✓	✓	✓	✓	✓	✓	✓	✓

Attribute:	1	2	3	4	5	6	7	8
<b>ON</b>	Burg. Event	Fire Event	Panic Event	Medical Event	Supervisory Event	Priority Event	Duress Event	Follows Timer Latched
<b>OFF</b>	Disabled	Disabled	Disabled	Disabled	Disabled	Disabled	Disabled	Disabled
10 System Event	✓	✓	✓	✓	✓	✓	✓	✓

Section	PGM	PGM Type	1	2	3	4	5	6	7	8
[501]	1	_ _	_ _	_ _	_ _	_ _	_ _	_ _	_ _	_ _
[502]	2	_ _	_ _	_ _	_ _	_ _	_ _	_ _	_ _	_ _

**[591-592] Inactivity Timers 1 & 2 Start and End Times**

Section	Default	Start Time	Default	End Time	Valid times are 00:00-23:59 hours. 9999 to disable
[591] Timer #1	9999	_ _ _ _	9999	_ _ _ _	
[592] Timer #2	9999	_ _ _ _	9999	_ _ _ _	

**[600] 2-way Audio Control Options 1**

Opt	Def.	ON	OFF
1	<input type="checkbox"/>	Tampers Enabled	✓ <input type="checkbox"/> Tampers Disabled
2	<input type="checkbox"/>	Openings & Closings Enabled	✓ <input type="checkbox"/> Openings & Closings Disabled
3	✓ <input type="checkbox"/>	[A] Key Alarm Enabled	<input type="checkbox"/> [A] Key Alarm Disabled
4	✓ <input type="checkbox"/>	[P] Key Alarm Enabled	<input type="checkbox"/> [P] Key Alarm Disabled
5	✓ <input type="checkbox"/>	Duress Alarm Enabled (Listen)	<input type="checkbox"/> Duress Alarm Disabled
6	✓ <input type="checkbox"/>	Opening After Alarm Enabled	<input type="checkbox"/> Opening After Alarm Disabled
*7	<input type="checkbox"/>	Siren Active during 2-way Audio Verification	✓ <input type="checkbox"/> Siren Silent during 2-way Audio Verification
8	<input type="checkbox"/>	2-Way Audio Is Initiated By The CS Operator	✓ <input type="checkbox"/> 2-Way Audio Session Is Immediate

\* This option must be ON for UL Listed Installations

**[601] 2-way Audio Control Options 2**

Opt	Def.	ON	OFF
1	<input type="checkbox"/>	Talk/Listen on Phone #1 Enabled*	✓ <input type="checkbox"/> Talk/Listen on Phone #1 Disabled
2	<input type="checkbox"/>	Talk/Listen on Phone #2 Enabled*	✓ <input type="checkbox"/> Talk/Listen on Phone #2 Disabled
3	<input type="checkbox"/>	Talk/Listen on Phone #3 Enabled	✓ <input type="checkbox"/> Talk/Listen on Phone #3 Disabled
4	<input type="checkbox"/>	Talk/Listen on Phone #4 Enabled	✓ <input type="checkbox"/> Talk/Listen on Phone #4 Disabled
5-8	<input type="checkbox"/>	Future Use	

\*When using redundant communications with phone line and alternate communicator, if 2-way audio is enabled, a 2-way voice session is established over both paths at the same time.

**[609] Module Tamper Reporting Codes**

_ _	Keypad 1 Tamper	_ _	Siren 1 Tamper
_ _	Keypad 2 Tamper	_ _	Siren 2 Tamper
_ _	Keypad 3 Tamper	_ _	Siren 3 Tamper
_ _	Keypad 4 Tamper	_ _	Siren 4 Tamper
_ _	Keypad 1 Tamper Restore	_ _	Siren 1 Tamper Restore
_ _	Keypad 2 Tamper Restore	_ _	Siren 2 Tamper Restore
_ _	Keypad 3 Tamper Restore	_ _	Siren 3 Tamper Restore
_ _	Keypad 4 Tamper Restore	_ _	Siren 4 Tamper Restore

**[610] Alternate Communicator Receiver Trouble Reporting Codes**

_ _	Receiver 1 Trouble	_ _	Receiver 1 Trouble Restore
_ _	Receiver 2 Trouble	_ _	Receiver 2 Trouble Restore
_ _	Receiver 3 Trouble	_ _	Receiver 3 Trouble Restore
_ _	Receiver 4 Trouble	_ _	Receiver 4 Trouble Restore
_ _	General Alternate Communicator Trouble	_ _	General Alternate Communicator Restore

**[611] Repeater Tamper/AC Loss Reporting Code**

_ _	Repeater 1 Tamper	_ _	Repeater 1 Tamper Restore
_ _	Repeater 2 Tamper	_ _	Repeater 2 Tamper Restore
_ _	Repeater 3 Tamper	_ _	Repeater 3 Tamper Restore
_ _	Repeater 4 Tamper	_ _	Repeater 4 Tamper Restore
_ _	Repeater 1 AC Loss	_ _	Repeater 1 AC Loss Restore
_ _	Repeater 2 AC Loss	_ _	Repeater 2 AC Loss Restore
_ _	Repeater 3 AC Loss	_ _	Repeater 3 AC Loss Restore
_ _	Repeater 4 AC Loss	_ _	Repeater 4 AC Loss Restore

## INTERNATIONAL PROGRAMMING

### [700] Automatic Clock Adjust

Default = 60  Valid Entries 00-99 Seconds

### [701] First International Options

Opt	Def.	ON	OFF
1	<input type="checkbox"/>	50 Hz AC	✓ <input type="checkbox"/> 60 Hz AC
2	<input type="checkbox"/>	Time Base - Internal Crystal	✓ <input type="checkbox"/> Time Base - AC Line
3	<input type="checkbox"/>	AC/DC Arming Inhibit Enabled	✓ <input type="checkbox"/> AC/DC Arming Inhibit Disabled
4	<input type="checkbox"/>	All System Tamper Require Installer Reset	✓ <input type="checkbox"/> All System Tamper Follow Restore
5	<input type="checkbox"/>	6-digit User Access Codes	✓ <input type="checkbox"/> 4-digit User Access Codes
6	<input type="checkbox"/>	Busy Tone Detection Enabled	✓ <input type="checkbox"/> Busy Tone Detection Disabled
7	<input type="checkbox"/>	High Capacity Battery Charge (On for G, D, I)	✓ <input type="checkbox"/> Standard Capacity Battery Charge
8	<input type="checkbox"/>	Future Use	

### [702] Second International Options

Opt	Def.	ON	OFF
1	<input type="checkbox"/>	Pulse Dialing Make/Break Ratio is 33/67	✓ <input type="checkbox"/> Pulse Dialing Make/Break Ratio is 40/60
2	✓ <input type="checkbox"/>	Force Dialing Enabled	<input type="checkbox"/> Force Dialing Disabled
3	<input type="checkbox"/>	Future Use	
4	<input type="checkbox"/>	1600Hz Handshake	✓ <input type="checkbox"/> Standard Handshake
5	<input type="checkbox"/>	ID Tone Enabled	✓ <input type="checkbox"/> ID Tone Disabled
6	<input type="checkbox"/>	2100 Hz ID Tone	✓ <input type="checkbox"/> 1300 Hz ID Tone
7-8	<input type="checkbox"/>	Future Use	

### [703] Delay Between Dialing Attempts

Default = 003  Valid entries are 000-255 seconds (entry + 5 seconds)

### [800] Door Chime Options for Zones 1-64

Option	Zone	1	2	3	4
		ON	Bing Bong	Ding Dong	Alarm
		OFF	Disabled	Disabled	Disabled
Section	Zone	Default	Default	Default	Default
[01]	1	✓ <input type="checkbox"/>	<input type="checkbox"/>	<input type="checkbox"/>	<input type="checkbox"/>
[02]	2	✓ <input type="checkbox"/>	<input type="checkbox"/>	<input type="checkbox"/>	<input type="checkbox"/>
[03]	3	✓ <input type="checkbox"/>	<input type="checkbox"/>	<input type="checkbox"/>	<input type="checkbox"/>
[04]	4	✓ <input type="checkbox"/>	<input type="checkbox"/>	<input type="checkbox"/>	<input type="checkbox"/>
[05]	5	✓ <input type="checkbox"/>	<input type="checkbox"/>	<input type="checkbox"/>	<input type="checkbox"/>
[06]	6	✓ <input type="checkbox"/>	<input type="checkbox"/>	<input type="checkbox"/>	<input type="checkbox"/>
[07]	7	✓ <input type="checkbox"/>	<input type="checkbox"/>	<input type="checkbox"/>	<input type="checkbox"/>
[08]	8	✓ <input type="checkbox"/>	<input type="checkbox"/>	<input type="checkbox"/>	<input type="checkbox"/>
[09]	9	✓ <input type="checkbox"/>	<input type="checkbox"/>	<input type="checkbox"/>	<input type="checkbox"/>
[10]	10	✓ <input type="checkbox"/>	<input type="checkbox"/>	<input type="checkbox"/>	<input type="checkbox"/>
[11]	11	✓ <input type="checkbox"/>	<input type="checkbox"/>	<input type="checkbox"/>	<input type="checkbox"/>
[12]	12	✓ <input type="checkbox"/>	<input type="checkbox"/>	<input type="checkbox"/>	<input type="checkbox"/>
[13]	13	✓ <input type="checkbox"/>	<input type="checkbox"/>	<input type="checkbox"/>	<input type="checkbox"/>
[14]	14	✓ <input type="checkbox"/>	<input type="checkbox"/>	<input type="checkbox"/>	<input type="checkbox"/>
[15]	15	✓ <input type="checkbox"/>	<input type="checkbox"/>	<input type="checkbox"/>	<input type="checkbox"/>
[16]	16	✓ <input type="checkbox"/>	<input type="checkbox"/>	<input type="checkbox"/>	<input type="checkbox"/>
[17]	17	✓ <input type="checkbox"/>	<input type="checkbox"/>	<input type="checkbox"/>	<input type="checkbox"/>
[18]	18	✓ <input type="checkbox"/>	<input type="checkbox"/>	<input type="checkbox"/>	<input type="checkbox"/>
[19]	19	✓ <input type="checkbox"/>	<input type="checkbox"/>	<input type="checkbox"/>	<input type="checkbox"/>
[20]	20	✓ <input type="checkbox"/>	<input type="checkbox"/>	<input type="checkbox"/>	<input type="checkbox"/>
[21]	21	✓ <input type="checkbox"/>	<input type="checkbox"/>	<input type="checkbox"/>	<input type="checkbox"/>
[22]	22	✓ <input type="checkbox"/>	<input type="checkbox"/>	<input type="checkbox"/>	<input type="checkbox"/>
[23]	23	✓ <input type="checkbox"/>	<input type="checkbox"/>	<input type="checkbox"/>	<input type="checkbox"/>

Option	Zone	1	2	3	4
		ON	Bing Bong	Ding Dong	Alarm
		OFF	Disabled	Disabled	Disabled
Section	Zone	Default	Default	Default	Default
[24]	24	✓ <input type="checkbox"/>	<input type="checkbox"/>	<input type="checkbox"/>	<input type="checkbox"/>
[25]	25	✓ <input type="checkbox"/>	<input type="checkbox"/>	<input type="checkbox"/>	<input type="checkbox"/>
[26]	26	✓ <input type="checkbox"/>	<input type="checkbox"/>	<input type="checkbox"/>	<input type="checkbox"/>
[27]	27	✓ <input type="checkbox"/>	<input type="checkbox"/>	<input type="checkbox"/>	<input type="checkbox"/>
[28]	28	✓ <input type="checkbox"/>	<input type="checkbox"/>	<input type="checkbox"/>	<input type="checkbox"/>
[29]	29	✓ <input type="checkbox"/>	<input type="checkbox"/>	<input type="checkbox"/>	<input type="checkbox"/>
[30]	30	✓ <input type="checkbox"/>	<input type="checkbox"/>	<input type="checkbox"/>	<input type="checkbox"/>
[32]	31	✓ <input type="checkbox"/>	<input type="checkbox"/>	<input type="checkbox"/>	<input type="checkbox"/>
[32]	32	✓ <input type="checkbox"/>	<input type="checkbox"/>	<input type="checkbox"/>	<input type="checkbox"/>
[33]	33	✓ <input type="checkbox"/>	<input type="checkbox"/>	<input type="checkbox"/>	<input type="checkbox"/>
[34]	34	✓ <input type="checkbox"/>	<input type="checkbox"/>	<input type="checkbox"/>	<input type="checkbox"/>
[35]	35	✓ <input type="checkbox"/>	<input type="checkbox"/>	<input type="checkbox"/>	<input type="checkbox"/>
[36]	36	✓ <input type="checkbox"/>	<input type="checkbox"/>	<input type="checkbox"/>	<input type="checkbox"/>
[37]	37	✓ <input type="checkbox"/>	<input type="checkbox"/>	<input type="checkbox"/>	<input type="checkbox"/>
[38]	38	✓ <input type="checkbox"/>	<input type="checkbox"/>	<input type="checkbox"/>	<input type="checkbox"/>
[39]	39	✓ <input type="checkbox"/>	<input type="checkbox"/>	<input type="checkbox"/>	<input type="checkbox"/>
[40]	40	✓ <input type="checkbox"/>	<input type="checkbox"/>	<input type="checkbox"/>	<input type="checkbox"/>
[41]	41	✓ <input type="checkbox"/>	<input type="checkbox"/>	<input type="checkbox"/>	<input type="checkbox"/>
[42]	42	✓ <input type="checkbox"/>	<input type="checkbox"/>	<input type="checkbox"/>	<input type="checkbox"/>
[43]	43	✓ <input type="checkbox"/>	<input type="checkbox"/>	<input type="checkbox"/>	<input type="checkbox"/>
[44]	44	✓ <input type="checkbox"/>	<input type="checkbox"/>	<input type="checkbox"/>	<input type="checkbox"/>
[45]	45	✓ <input type="checkbox"/>	<input type="checkbox"/>	<input type="checkbox"/>	<input type="checkbox"/>
[46]	46	✓ <input type="checkbox"/>	<input type="checkbox"/>	<input type="checkbox"/>	<input type="checkbox"/>

Section	Zone	Default	Default	Default	Default
[47]	47	✓ <input type="checkbox"/>	<input type="checkbox"/>	<input type="checkbox"/>	<input type="checkbox"/>
[48]	48	✓ <input type="checkbox"/>	<input type="checkbox"/>	<input type="checkbox"/>	<input type="checkbox"/>
[49]	49	✓ <input type="checkbox"/>	<input type="checkbox"/>	<input type="checkbox"/>	<input type="checkbox"/>
[50]	50	✓ <input type="checkbox"/>	<input type="checkbox"/>	<input type="checkbox"/>	<input type="checkbox"/>
[51]	51	✓ <input type="checkbox"/>	<input type="checkbox"/>	<input type="checkbox"/>	<input type="checkbox"/>
[52]	52	✓ <input type="checkbox"/>	<input type="checkbox"/>	<input type="checkbox"/>	<input type="checkbox"/>
[53]	53	✓ <input type="checkbox"/>	<input type="checkbox"/>	<input type="checkbox"/>	<input type="checkbox"/>
[54]	54	✓ <input type="checkbox"/>	<input type="checkbox"/>	<input type="checkbox"/>	<input type="checkbox"/>
[55]	55	✓ <input type="checkbox"/>	<input type="checkbox"/>	<input type="checkbox"/>	<input type="checkbox"/>

Section	Zone	Default	Default	Default	Default
[56]	56	✓ <input type="checkbox"/>	<input type="checkbox"/>	<input type="checkbox"/>	<input type="checkbox"/>
[57]	57	✓ <input type="checkbox"/>	<input type="checkbox"/>	<input type="checkbox"/>	<input type="checkbox"/>
[58]	58	✓ <input type="checkbox"/>	<input type="checkbox"/>	<input type="checkbox"/>	<input type="checkbox"/>
[59]	59	✓ <input type="checkbox"/>	<input type="checkbox"/>	<input type="checkbox"/>	<input type="checkbox"/>
[60]	60	✓ <input type="checkbox"/>	<input type="checkbox"/>	<input type="checkbox"/>	<input type="checkbox"/>
[61]	61	✓ <input type="checkbox"/>	<input type="checkbox"/>	<input type="checkbox"/>	<input type="checkbox"/>
[62]	62	✓ <input type="checkbox"/>	<input type="checkbox"/>	<input type="checkbox"/>	<input type="checkbox"/>
[63]	63	✓ <input type="checkbox"/>	<input type="checkbox"/>	<input type="checkbox"/>	<input type="checkbox"/>
[64]	64	✓ <input type="checkbox"/>	<input type="checkbox"/>	<input type="checkbox"/>	<input type="checkbox"/>

Note: Chime enable for openings and closings of zones follow the settings in Section [076] Options [1] and [2] when \* 4 chime enable.

**[804] Wireless programming**

**[804][001]-[064] Wireless Device Serial Numbers**

Zone	Sub Sec.	Serial Number	Zone	Sub Sec.	Serial Number
1	[001]	_____	33	[033]	_____
2	[002]	_____	34	[034]	_____
3	[003]	_____	35	[035]	_____
4	[004]	_____	36	[036]	_____
5	[005]	_____	37	[037]	_____
6	[006]	_____	38	[038]	_____
7	[007]	_____	39	[039]	_____
8	[008]	_____	40	[040]	_____
9	[009]	_____	41	[041]	_____
10	[010]	_____	42	[042]	_____
11	[011]	_____	43	[043]	_____
12	[012]	_____	44	[044]	_____
13	[013]	_____	45	[045]	_____
14	[014]	_____	46	[046]	_____
15	[015]	_____	47	[047]	_____
16	[016]	_____	48	[048]	_____
17	[017]	_____	49	[049]	_____
18	[018]	_____	50	[050]	_____
19	[019]	_____	51	[051]	_____
20	[020]	_____	52	[052]	_____
21	[021]	_____	53	[053]	_____
22	[022]	_____	54	[054]	_____
23	[023]	_____	55	[055]	_____
24	[024]	_____	56	[056]	_____
25	[025]	_____	57	[057]	_____
26	[026]	_____	58	[058]	_____
27	[027]	_____	59	[059]	_____
28	[028]	_____	60	[060]	_____
29	[029]	_____	61	[061]	_____
30	[030]	_____	62	[062]	_____
31	[031]	_____	63	[063]	_____
32	[032]	_____	64	[064]	_____

**[804][081] Wireless Supervisory Window**

Default 096 EU008 \_\_\_\_\_

Value=Entry x 15 minutes. E.g., 6 x 15 minutes equals 1.5 hours. Valid entries are 4-96 (1 hour -24 hours)

**[804][082]-[089] Zone Transmitter Supervision Options**

<b>[082] Zone 1-8</b>		<b>[083] Zones 9-16</b>		<b>[084] Zones 17-24</b>		<b>[085] Zones 25-32</b>		
Opt	Def.	Def.	Def.	Def.	Def.	Def.	Def.	
1	✓ <input type="checkbox"/>	Zone 1	✓ <input type="checkbox"/>	Zone 9	✓ <input type="checkbox"/>	Zone 17	✓ <input type="checkbox"/>	Zone 25
2	✓ <input type="checkbox"/>	Zone 2	✓ <input type="checkbox"/>	Zone 10	✓ <input type="checkbox"/>	Zone 18	✓ <input type="checkbox"/>	Zone 26
3	✓ <input type="checkbox"/>	Zone 3	✓ <input type="checkbox"/>	Zone 11	✓ <input type="checkbox"/>	Zone 19	✓ <input type="checkbox"/>	Zone 27
4	✓ <input type="checkbox"/>	Zone 4	✓ <input type="checkbox"/>	Zone 12	✓ <input type="checkbox"/>	Zone 20	✓ <input type="checkbox"/>	Zone 28
5	✓ <input type="checkbox"/>	Zone 5	✓ <input type="checkbox"/>	Zone 13	✓ <input type="checkbox"/>	Zone 21	✓ <input type="checkbox"/>	Zone 29
6	✓ <input type="checkbox"/>	Zone 6	✓ <input type="checkbox"/>	Zone 14	✓ <input type="checkbox"/>	Zone 22	✓ <input type="checkbox"/>	Zone 30
7	✓ <input type="checkbox"/>	Zone 7	✓ <input type="checkbox"/>	Zone 15	✓ <input type="checkbox"/>	Zone 23	✓ <input type="checkbox"/>	Zone 31
8	✓ <input type="checkbox"/>	Zone 8	✓ <input type="checkbox"/>	Zone 16	✓ <input type="checkbox"/>	Zone 24	✓ <input type="checkbox"/>	Zone 32

<b>[086] Zone 33-40</b>		<b>[087] Zones 41-48</b>		<b>[088] Zones 49-56</b>		<b>[089] Zones 57-64</b>		
Opt	Def.	Def.	Def.	Def.	Def.	Def.	Def.	
1	✓ <input type="checkbox"/>	Zone 33	✓ <input type="checkbox"/>	Zone 41	✓ <input type="checkbox"/>	Zone 49	✓ <input type="checkbox"/>	Zone 57
2	✓ <input type="checkbox"/>	Zone 34	✓ <input type="checkbox"/>	Zone 42	✓ <input type="checkbox"/>	Zone 50	✓ <input type="checkbox"/>	Zone 58
3	✓ <input type="checkbox"/>	Zone 35	✓ <input type="checkbox"/>	Zone 43	✓ <input type="checkbox"/>	Zone 51	✓ <input type="checkbox"/>	Zone 59
4	✓ <input type="checkbox"/>	Zone 36	✓ <input type="checkbox"/>	Zone 44	✓ <input type="checkbox"/>	Zone 52	✓ <input type="checkbox"/>	Zone 60
5	✓ <input type="checkbox"/>	Zone 37	✓ <input type="checkbox"/>	Zone 45	✓ <input type="checkbox"/>	Zone 53	✓ <input type="checkbox"/>	Zone 61
6	✓ <input type="checkbox"/>	Zone 38	✓ <input type="checkbox"/>	Zone 46	✓ <input type="checkbox"/>	Zone 54	✓ <input type="checkbox"/>	Zone 62
7	✓ <input type="checkbox"/>	Zone 39	✓ <input type="checkbox"/>	Zone 47	✓ <input type="checkbox"/>	Zone 55	✓ <input type="checkbox"/>	Zone 63
8	✓ <input type="checkbox"/>	Zone 40	✓ <input type="checkbox"/>	Zone 48	✓ <input type="checkbox"/>	Zone 56	✓ <input type="checkbox"/>	Zone 64

**[804][101]-[156] Wireless Key Programming**

Wireless Key Programming										Enable/Disable	
Sub	Serial Number	Sub	#1	#2	#3	#4	#5	#6	Sub	Def.	Def.
Sect.		Sect.	Def.03	Def.04	Def.27	Def.30	Def.13	Def.14	Sect.	Def.	Def.
1	[101] <input type="text"/>	[141] <input type="text"/>	<input type="text"/>	<input type="text"/>	<input type="text"/>	<input type="text"/>	<input type="text"/>	<input type="text"/>	[181]	✓	<input type="checkbox"/>
2	[102] <input type="text"/>	[142] <input type="text"/>	<input type="text"/>	<input type="text"/>	<input type="text"/>	<input type="text"/>	<input type="text"/>	<input type="text"/>		✓	<input type="checkbox"/>
3	[103] <input type="text"/>	[143] <input type="text"/>	<input type="text"/>	<input type="text"/>	<input type="text"/>	<input type="text"/>	<input type="text"/>	<input type="text"/>		✓	<input type="checkbox"/>
4	[104] <input type="text"/>	[144] <input type="text"/>	<input type="text"/>	<input type="text"/>	<input type="text"/>	<input type="text"/>	<input type="text"/>	<input type="text"/>		✓	<input type="checkbox"/>
5	[105] <input type="text"/>	[145] <input type="text"/>	<input type="text"/>	<input type="text"/>	<input type="text"/>	<input type="text"/>	<input type="text"/>	<input type="text"/>		✓	<input type="checkbox"/>
6	[106] <input type="text"/>	[146] <input type="text"/>	<input type="text"/>	<input type="text"/>	<input type="text"/>	<input type="text"/>	<input type="text"/>	<input type="text"/>		✓	<input type="checkbox"/>
7	[107] <input type="text"/>	[147] <input type="text"/>	<input type="text"/>	<input type="text"/>	<input type="text"/>	<input type="text"/>	<input type="text"/>	<input type="text"/>		✓	<input type="checkbox"/>
8	[108] <input type="text"/>	[148] <input type="text"/>	<input type="text"/>	<input type="text"/>	<input type="text"/>	<input type="text"/>	<input type="text"/>	<input type="text"/>		✓	<input type="checkbox"/>
9	[109] <input type="text"/>	[149] <input type="text"/>	<input type="text"/>	<input type="text"/>	<input type="text"/>	<input type="text"/>	<input type="text"/>	<input type="text"/>	[182]	✓	<input type="checkbox"/>
10	[110] <input type="text"/>	[150] <input type="text"/>	<input type="text"/>	<input type="text"/>	<input type="text"/>	<input type="text"/>	<input type="text"/>	<input type="text"/>		✓	<input type="checkbox"/>
11	[111] <input type="text"/>	[151] <input type="text"/>	<input type="text"/>	<input type="text"/>	<input type="text"/>	<input type="text"/>	<input type="text"/>	<input type="text"/>		✓	<input type="checkbox"/>
12	[112] <input type="text"/>	[152] <input type="text"/>	<input type="text"/>	<input type="text"/>	<input type="text"/>	<input type="text"/>	<input type="text"/>	<input type="text"/>		✓	<input type="checkbox"/>
13	[113] <input type="text"/>	[153] <input type="text"/>	<input type="text"/>	<input type="text"/>	<input type="text"/>	<input type="text"/>	<input type="text"/>	<input type="text"/>		✓	<input type="checkbox"/>
14	[114] <input type="text"/>	[154] <input type="text"/>	<input type="text"/>	<input type="text"/>	<input type="text"/>	<input type="text"/>	<input type="text"/>	<input type="text"/>		✓	<input type="checkbox"/>
15	[115] <input type="text"/>	[155] <input type="text"/>	<input type="text"/>	<input type="text"/>	<input type="text"/>	<input type="text"/>	<input type="text"/>	<input type="text"/>		✓	<input type="checkbox"/>
16	[116] <input type="text"/>	[156] <input type="text"/>	<input type="text"/>	<input type="text"/>	<input type="text"/>	<input type="text"/>	<input type="text"/>	<input type="text"/>		✓	<input type="checkbox"/>

**[804][181] Wireless Key 1-8 Enable/Disable**

Opt	Def.	ON	OFF
1	✓ <input type="checkbox"/>	Key 1 Enabled	<input type="checkbox"/> Key 1 Disabled
2	✓ <input type="checkbox"/>	Key 2 Enabled	<input type="checkbox"/> Key 2 Disabled
3	✓ <input type="checkbox"/>	Key 3 Enabled	<input type="checkbox"/> Key 3 Disabled
4	✓ <input type="checkbox"/>	Key 4 Enabled	<input type="checkbox"/> Key 4 Disabled
5	✓ <input type="checkbox"/>	Key 5 Enabled	<input type="checkbox"/> Key 5 Disabled
6	✓ <input type="checkbox"/>	Key 6 Enabled	<input type="checkbox"/> Key 6 Disabled
7	✓ <input type="checkbox"/>	Key 7 Enabled	<input type="checkbox"/> Key 7 Disabled
8	✓ <input type="checkbox"/>	Key 8 Enabled	<input type="checkbox"/> Key 8 Disabled



**[804][182] Wireless Key 9-16 Enable/Disable**

Opt	Def.	ON	OFF
1	✓	<input type="checkbox"/> Key 9 Enabled	<input type="checkbox"/> Key 9 Disabled
2	✓	<input type="checkbox"/> Key 10 Enabled	<input type="checkbox"/> Key 10 Disabled
3	✓	<input type="checkbox"/> Key 11 Enabled	<input type="checkbox"/> Key 11 Disabled
4	✓	<input type="checkbox"/> Key 12 Enabled	<input type="checkbox"/> Key 12 Disabled
5	✓	<input type="checkbox"/> Key 13 Enabled	<input type="checkbox"/> Key 13 Disabled
6	✓	<input type="checkbox"/> Key 14 Enabled	<input type="checkbox"/> Key 14 Disabled
7	✓	<input type="checkbox"/> Key 15 Enabled	<input type="checkbox"/> Key 15 Disabled
8	✓	<input type="checkbox"/> Key 16 Enabled	<input type="checkbox"/> Key 16 Disabled

**[804][201]-[204] Wireless Keypad Serial Number**

Wireless keypad #01 Serial Number	Def.	00000000	_ _ _ _ _ _ _ _ _ _ _ _ _ _ _ _
Wireless keypad #02 Serial Number	Def.	00000000	_ _ _ _ _ _ _ _ _ _ _ _ _ _ _ _
Wireless keypad #03 Serial Number	Def.	00000000	_ _ _ _ _ _ _ _ _ _ _ _ _ _ _ _
Wireless keypad #04 Serial Number	Def.	00000000	_ _ _ _ _ _ _ _ _ _ _ _ _ _ _ _

**[804][301]-[304] Wireless Siren Serial Number**

[301] Wireless Siren #01 Serial Number	Def.	00000000	_ _ _ _ _ _ _ _ _ _ _ _ _ _ _ _
[302] Wireless Siren #02 Serial Number	Def.	00000000	_ _ _ _ _ _ _ _ _ _ _ _ _ _ _ _
[303] Wireless Siren #03 Serial Number	Def.	00000000	_ _ _ _ _ _ _ _ _ _ _ _ _ _ _ _
[304] Wireless Siren #04 Serial Number	Def.	00000000	_ _ _ _ _ _ _ _ _ _ _ _ _ _ _ _

**[804][311] Wireless Siren #1 Options**

Opt	Def.	ON	OFF
1	✓	<input type="checkbox"/> Siren Alarm Enabled	<input type="checkbox"/> Siren Alarm Disabled
2	✓	<input type="checkbox"/> Buzzer Notifications Enabled	<input type="checkbox"/> Buzzer Notifications Disabled
3	✓	<input type="checkbox"/> Door Chime Enabled	<input type="checkbox"/> Door Chime Disabled
4	✓	<input type="checkbox"/> Trouble Beeps Enabled	<input type="checkbox"/> Trouble Beeps Disabled
5		<input type="checkbox"/> Squawks Enabled	✓ <input type="checkbox"/> Squawks Disabled
6		<input type="checkbox"/> Enable Strobe	✓ <input type="checkbox"/> Disable Strobe
7		<input type="checkbox"/> Buzzer Alarm / Strobe Follows BTO	✓ <input type="checkbox"/> Buzzer Alarm / Strobe Follows Alarm Condition
8		<input type="checkbox"/> Siren Tamper Enabled	✓ <input type="checkbox"/> Siren Tamper Disabled

**[804][312] Wireless Siren #2 Options**

Opt	Def.	ON	OFF
1	✓	<input type="checkbox"/> Siren Alarm Enabled	<input type="checkbox"/> Siren Alarm Disabled
2	✓	<input type="checkbox"/> Buzzer Notifications Enabled	<input type="checkbox"/> Buzzer Notifications Disabled
3	✓	<input type="checkbox"/> Door Chime Enabled	<input type="checkbox"/> Door Chime Disabled
4	✓	<input type="checkbox"/> Trouble Beeps Enabled	<input type="checkbox"/> Trouble Beeps Disabled
5		<input type="checkbox"/> Squawks Enabled	✓ <input type="checkbox"/> Squawks Disabled
6		<input type="checkbox"/> Enable Strobe	✓ <input type="checkbox"/> Disable Strobe
7		<input type="checkbox"/> Buzzer Alarm / Strobe Follows BTO	✓ <input type="checkbox"/> Buzzer Alarm / Strobe Follows Alarm Condition
8		<input type="checkbox"/> Siren Tamper Enabled	✓ <input type="checkbox"/> Siren Tamper Disabled

**[804][313] Wireless Siren #3 Options**

Opt	Def.	ON	OFF
1	✓	<input type="checkbox"/> Siren Alarm Enabled	<input type="checkbox"/> Siren Alarm Disabled
2	✓	<input type="checkbox"/> Buzzer Notifications Enabled	<input type="checkbox"/> Buzzer Notifications Disabled
3	✓	<input type="checkbox"/> Door Chime Enabled	<input type="checkbox"/> Door Chime Disabled
4	✓	<input type="checkbox"/> Trouble Beeps Enabled	<input type="checkbox"/> Trouble Beeps Disabled
5		<input type="checkbox"/> Squawks Enabled	✓ <input type="checkbox"/> Squawks Disabled
6		<input type="checkbox"/> Enable Strobe	✓ <input type="checkbox"/> Disable Strobe
7		<input type="checkbox"/> Buzzer Alarm / Strobe Follows BTO	✓ <input type="checkbox"/> Buzzer Alarm / Strobe Follows Alarm Condition
8		<input type="checkbox"/> Siren Tamper Enabled	✓ <input type="checkbox"/> Siren Tamper Disabled

**[804][314] Wireless Siren #4 Options**

Opt	Def.	ON	OFF
1	✓	<input type="checkbox"/> Siren Alarm Enabled	<input type="checkbox"/> Siren Alarm Disabled
2	✓	<input type="checkbox"/> Buzzer Notifications Enabled	<input type="checkbox"/> Buzzer Notifications Disabled
3	✓	<input type="checkbox"/> Door Chime Enabled	<input type="checkbox"/> Door Chime Disabled
4	✓	<input type="checkbox"/> Trouble Beeps Enabled	<input type="checkbox"/> Trouble Beeps Disabled
5		<input type="checkbox"/> Squawks Enabled	✓ <input type="checkbox"/> Squawks Disabled
6		<input type="checkbox"/> Enable Strobe	✓ <input type="checkbox"/> Disable Strobe
7		<input type="checkbox"/> Buzzer Alarm / Strobe Follows BTO	✓ <input type="checkbox"/> Buzzer Alarm / Strobe Follows Alarm Condition
8		<input type="checkbox"/> Siren Tamper Enabled	✓ <input type="checkbox"/> Siren Tamper Disabled

**[804][320] Global Siren Options**

Opt	Def.	ON	OFF
1		<input type="checkbox"/> Tamper Activates Siren/Strobe While Disarmed	✓ <input type="checkbox"/> Tamper Does Not Activate Siren/Strobe While Disarmed
2		<input type="checkbox"/> Pre-Alarm Signal Enabled	✓ <input type="checkbox"/> Pre-Alarm Signal Disabled
3-8		<input type="checkbox"/> Future Use	

**[804][330] Maximum Outdoor Siren Activation Timer**

Default 010 

--	--	--

 Valid Entries are 001-255 minutes

**[804][401]-[404] Wireless Repeater Programming**

[401] Wireless Repeater #01 Serial Number	Def.	00000000	<table border="1" style="display: inline-table; border-collapse: collapse; text-align: center;"><tr><td style="width: 20px; height: 15px;"> </td><td style="width: 20px; height: 15px;"> </td><td style="width: 20px; height: 15px;"> </td><td style="width: 20px; height: 15px;"> </td><td style="width: 20px; height: 15px;"> </td><td style="width: 20px; height: 15px;"> </td><td style="width: 20px; height: 15px;"> </td><td style="width: 20px; height: 15px;"> </td></tr></table>								
[402] Wireless Repeater #02 Serial Number	Def.	00000000	<table border="1" style="display: inline-table; border-collapse: collapse; text-align: center;"><tr><td style="width: 20px; height: 15px;"> </td><td style="width: 20px; height: 15px;"> </td><td style="width: 20px; height: 15px;"> </td><td style="width: 20px; height: 15px;"> </td><td style="width: 20px; height: 15px;"> </td><td style="width: 20px; height: 15px;"> </td><td style="width: 20px; height: 15px;"> </td><td style="width: 20px; height: 15px;"> </td></tr></table>								
[403] Wireless Repeater #03 Serial Number	Def.	00000000	<table border="1" style="display: inline-table; border-collapse: collapse; text-align: center;"><tr><td style="width: 20px; height: 15px;"> </td><td style="width: 20px; height: 15px;"> </td><td style="width: 20px; height: 15px;"> </td><td style="width: 20px; height: 15px;"> </td><td style="width: 20px; height: 15px;"> </td><td style="width: 20px; height: 15px;"> </td><td style="width: 20px; height: 15px;"> </td><td style="width: 20px; height: 15px;"> </td></tr></table>								
[404] Wireless Repeater #04 Serial Number	Def.	00000000	<table border="1" style="display: inline-table; border-collapse: collapse; text-align: center;"><tr><td style="width: 20px; height: 15px;"> </td><td style="width: 20px; height: 15px;"> </td><td style="width: 20px; height: 15px;"> </td><td style="width: 20px; height: 15px;"> </td><td style="width: 20px; height: 15px;"> </td><td style="width: 20px; height: 15px;"> </td><td style="width: 20px; height: 15px;"> </td><td style="width: 20px; height: 15px;"> </td></tr></table>								

1 For repeater supervision, ensure that dip switch 3 on the repeater is in the OFF state.

**[804][900] General Wireless Options**

Opt	Def.	ON	OFF
1		<input type="checkbox"/> Repeater Harsh Placement Test Enabled	✓ <input type="checkbox"/> Repeater Harsh Placement Test Disabled
2-6		Future Use	
7		<input type="checkbox"/> RF Jam Disabled	✓ <input type="checkbox"/> RF Jam Enabled
8		<input type="checkbox"/> Future Use	<input type="checkbox"/>

**[850] Cellular Signal Strength**

Enter [\*][8][Installer Code][850] to display the Cellular network signal strength on the SCW9055/57 LCD. Scroll down to view. 5 bars indicates maximum signal strength.

**[851] Alternate Communicator Programming**

For information regarding programming the alternate communicator, refer to the communicator installation manual.

---

## Special Installer Functions (Accessible through Installer Programming)

### [898] Wireless Device Enrollment (See Section 2)

### [899] Template Programming (See Section 3)

### [900] Panel Version

    | | | | |      Not Programmable (e.g. Ver. 1.0 = 0100)

### [904]-[907] Wireless Device Placement Test

Enter [\*][8][Installer Code][904], [905] [906] or [907] to placement test wireless zones, keypad, sirens and repeaters respectively. See “2.3 Wireless Device Setup” on page 7.

### [908] Wireless Modules

Enter [\*][8][Installer Code][908] to display all wireless modules enrolled on the system. Scroll to display the name and slot number of each device. e.g., an indoor siren enrolled on slot one is displayed as 'WT49X1 1.'

### [990] Installer Lockout Enable

Enter [990][Installer Code][990]

### [991] Installer Lockout Disable

Enter [991][Installer Code][991]

### [992] Alternate Communicator Label Broadcast

Enter [992][\*]   **Note:** Perform the alternate communicator label broadcast at the SCW9055/57 main unit.

### [996] Restore Wireless Device Programming Factory Defaults

Enter [996][Installer Code][996]

### [998] Restore Panel Default Programming

Enter [998][Installer Code][998]

### [999] Restore Factory Default Programming

Enter [999][Installer Code][999]

### Local Keypad Programming

Enter [\*] when in Installer Programming to access keypad programming.

### [000] Keypad Function Key Programming

#### Function Key Options

- |                          |                                 |  |
|--------------------------|---------------------------------|--|
| [00] Null Key            | [09] Future Use                 | [25] Instant Stay Arm*                         |
| [01] Future Use          | [10] Future Use                 | [26]-[32] Future Use                           |
| [02] Future Use          | [11] Future Use                 | [33] Night Arm                                 |
| [03] Stay Arm            | [12] Future Use                 |  |
| [04] Away Arm            | [13] Command Output #1          |  |
| [05] [*][9]No Entry Arm  | [14] Command Output #2          | * Do not use this function key on CP-01 panels |
| [06] [*][4] Chime On/Off | [15] Future Use                 |  |
| [07] Future Use          | [16] [*][0] Quick Exit          |  |
| [08] [*][1] Bypass       | [17] Reactivate Stay/Away zones |  |

#### Default Key 1    Default Key 2    Default Key 3    Default Key 4    Default Key 5

|\_0\_|\_|3\_|    |\_0\_|\_|4\_|    |\_0\_|\_|6\_|    |\_0\_|\_|8\_|    |\_1\_|\_|6\_|

### [001]-[064] Label Programming (Zone 1-64)

Zone	Sub	Default	Zone	Sub	XX = 01 - 64
	Sect.	Z O N E    X X		Sect.	
1	[001]	-----	13	[013]	
2	[002]		14	[014]	
3	[003]		15	[015]	
4	[004]		16	[016]	
5	[005]		17	[017]	
6	[006]		18	[018]	
7	[007]		19	[019]	
8	[008]		20	[020]	
9	[009]		21	[021]	
10	[010]		22	[022]	
11	[011]		23	[023]	
12	[012]		24	[024]	

Zone	Sub	Default	Zone	Sub	XX = 01 - 64
Sect.	ZONE	XX	Sect.		
25	[025]	-----	45	[045]	
26	[026]		46	[046]	
27	[027]		47	[047]	
28	[028]		48	[048]	
29	[029]		49	[049]	
30	[030]		50	[050]	
31	[031]		51	[051]	
32	[032]		52	[052]	
33	[033]		53	[053]	
34	[034]		54	[054]	
35	[035]		55	[055]	
36	[036]		56	[056]	
37	[037]		57	[057]	
38	[038]		58	[058]	
39	[039]		59	[059]	
40	[040]		60	[060]	
41	[041]		61	[061]	
42	[042]		62	[062]	
43	[043]		63	[063]	
44	[044]		64	[064]	

**[065] Fire Alarm Label (2 x 14 characters)**

Default

F I R E \_ Z O N E \_ \_ \_ \_ \_

\_ \_ \_ \_ \_

**[066] Fail to Arm Event Message (2 x 16 characters)**

Default

S Y S T E M \_ H A S \_ \_ \_ \_ \_

F A I L E D \_ T O \_ A R M \_ \_ \_

**[067] Alarm When Armed Event Message (2 x 16 characters)**

Default

A L A R M \_ O C C U R R E D \_ \_ \_

W H I L E \_ A R M E D \_ \_ \_ < >

**[074] First Keypad Options**

Opt	Def.	ON	OFF
1	✓	<input type="checkbox"/> [F] Key Enabled	<input type="checkbox"/> [F] Key Disabled
2	✓	<input type="checkbox"/> [A] Key Enabled	<input type="checkbox"/> [A] Key Disabled
3	✓	<input type="checkbox"/> [P] Key Enabled	<input type="checkbox"/> [P] Key Disabled
4	✓	<input type="checkbox"/> Quick Arm Prompt ON	<input type="checkbox"/> Quick Arm Prompt OFF
5		<input type="checkbox"/> Quick Exit Prompt ON	✓ <input type="checkbox"/> Quick Exit Prompt OFF
6	✓	<input type="checkbox"/> Bypass Options Prompt ON	<input type="checkbox"/> Bypass Options Prompt OFF
7	✓	<input type="checkbox"/> User Initiated Call-up Prompt ON	<input type="checkbox"/> User Initiated Call-up Prompt OFF
8	✓	<input type="checkbox"/> Hold [P]anic Key Prompt ON	<input type="checkbox"/> Hold [P]anic Key Prompt OFF

**[075] Second Keypad Options**

Opt	Def.	ON	OFF
1	✓	<input type="checkbox"/> Local Clock Display Enabled	<input type="checkbox"/> Local Clock Display Disabled
2		<input type="checkbox"/> Local Clock Displays 24 Hr. Time	✓ <input type="checkbox"/> Local Clock Displays AM/PM
3	✓	<input type="checkbox"/> Auto Alarm Scroll Enabled	<input type="checkbox"/> Auto Alarm Scroll Disabled
4	✓	<input type="checkbox"/> Language Selection Accessible From Any Menu	<input type="checkbox"/> Language Selection Accessible From Installer Only
5		<input type="checkbox"/> Power LED Enabled	✓ <input type="checkbox"/> Power LED Disabled
6	✓	<input type="checkbox"/> Power LED Indicates AC Present	<input type="checkbox"/> Power LED Indicates AC Absent
7	✓	<input type="checkbox"/> Alarms are Displayed While Armed	<input type="checkbox"/> Alarms Are NOT Displayed While Armed
8		<input type="checkbox"/> Auto Scroll Open Zones Enabled	✓ <input type="checkbox"/> Auto Scroll Open Zones Disabled

**[076] Third Keypad Options**

Opt	Def.	ON	OFF
1-4		<input type="checkbox"/> Future Use	
5	✓	<input type="checkbox"/> Late To Open Prompts Enabled	<input type="checkbox"/> Late To Open Prompts Disabled
6-8		<input type="checkbox"/> Future Use	

**[077] Programmed LCD Message (2 x 16 Characters)**

**[078] Programmed LCD Message Duration**

|\_|\_|\_|\_|\_|\_|\_| Default 003 (Valid entries are 000-255, 000=unlimited message display)

**[100] CO Detector Alarm Label (2 x 14 Characters)**

Default

CO\_ALARM \_

EVACUATE \_ AREA \_ \_ \_ \_ \_ \_ \_ \_ \_ \_ \_ \_ \_ \_ \_ \_ \_ \_

**[101] System Label (2 x 14 Characters)**

Default

SYSTEM \_

\_ \_

**[120] Command Output 1 Label (2 x 14 Characters)**

Default

COMMAND \_ O/P \_ 1 \_ \_ \_ \_ \_ \_ \_ \_ \_ \_ \_ \_ \_ \_ \_ \_ \_ \_

\_ \_

**[121] Command Output 2 Label (2 x 14 Characters)**

Default

COMMAND \_ O/P \_ 2 \_ \_ \_ \_ \_ \_ \_ \_ \_ \_ \_ \_ \_ \_ \_ \_ \_ \_

\_ \_

**[996] Label Default**

Enter [996][\*]

**[997] Keypad Version**

Enter [997] Read only (e.g., 1234 = version 12.34)

**[998] Initiate Global Label Broadcast**Enter [998][\*] Note: Label Broadcast must be initiated by Keypad 1. **Note:** Label broadcast must be initiated by the SCW9055/57 main unit.**[999] Reset All Keypad Programming To Factory Defaults**

Enter [999][\*]

## 5.4 Programming Descriptions

The following is a description of the programming features and options available in the control panel.

### [001]-[004] Zone Definitions

- i** Fire zones and 24-Hour zones go into alarm whether the system is armed or disarmed and do not follow the exit delay.
- 00 Null Zone:** This zone type is intended for zones that are NOT used.
- 01 Delay 1:** This zone type follows the Entry Delay 1 and Exit Delay timers programmed in section [005] and is normally used for entry/exit doors. The exit delay starts as soon as the panel is armed. The zone may be opened and closed during the delay time without causing an alarm. After the exit delay time has expired, opening the zone starts the entry delay timer. During the entry delay time, the keypad buzzer sounds steadily to advise the user that the system should be disarmed. If the panel is disarmed before the entry delay expires, no alarm is generated.
- 02 Delay 2:** This zone type operates the same as the Delay 1 [01] zone except it follows the Entry Delay 2 time which is set in section [005].
- 03 Instant:** This zone type is normally used for door/window contacts, but is instant when opened after the exit delay expires.
- 04 Interior:** This zone type is used with interior motion detectors. Interior zones have an exit delay and an entry delay if a delay type zone has been violated first. The zone goes into alarm when the entry delay of the delay type zone has expired, if the system has not been disarmed. If the protected area is entered without entering the delayed entrance and an interior zone is violated, an immediate alarm is generated.
- 05 Interior Stay/Away:** If the system is Stay armed, this zone type is bypassed. If the system is Away armed, the zone acts like an interior type zone [04].
- 06 Delay Stay/Away:** If the system is Stay armed, this zone type is bypassed. If the system is Away armed, this zone will always follow the entry delay time for Entry Delay 1 when violated.
- i** The automatic bypass on Stay/Away type zones is NOT removed by any event other than a valid exit through a delay type 1 zone during the exit delay, arming using the Away function key or by pressing [\*][1] while armed.

### 07-08 Future Use

- 09 24 Hour Supervisory (Hardwired):** The zone is similar to a fire zone. Supervision options (NC, EOL, and DEOL) do not affect the functionality of the zone. The Restored state of this zone type is 5.6 K zone end-of-line, the Alarm state is Short and the trouble state is Open.
- i** This zone type must not be used for wireless zones.
- 10 24 Hour Supervisory Buzzer:** When triggered, the system buzzer sounds steadily at medium volume until a valid access code is entered.
- 11 24 Hour Burglary:** This zone type is active at all times. It reports an alarm if the panel is armed or disarmed. This zone type sounds the bell for the length of Bell cut-off (section [005]) if the audible attribute is enabled.
- 12 Future Use**
- 13 24 Hour Gas:** Similar to 24 Hour Burglary except for System Event output type and SIA identifier.
- 14 24 Hour Heat:** Similar to 24 Hour Burglary except for System Event output type and SIA identifier.
- 15 24 Hour Medical:** Similar to 24 Hour Burglary except for System Event output type and SIA identifier.
- 16 24 Hour Panic:** Similar to 24 Hour Burglary except for System Event output type and SIA identifier.
- 17 24 Hour Emergency:** Similar to 24 Hour Burglary except for System Event output type and SIA identifier.
- 18 Future Use**
- 19 24 Hour Water:** Similar to 24 Hour Burglary except for System Event output type and SIA identifier.
- 20 24 Hour Freeze:** Similar to 24 Hour Burglary except for System Event output type and SIA identifier.
- 21 Future Use**
- 22 Momentary Keyswitch Arm:** A keyswitch device may be connected to the zone programmed as momentary keyswitch arm. Momentary activation of the zone alternately arms/disarms the system and silences alarms. Tamper and faults only initiate their respective trouble sequence. The keypad does not display an indication when this type of zone is activated.
- i** With audible alarm active, using the keyswitch when disarmed is the same as entering an access code at the keypad. Using the keyswitch during the first 30 seconds of a delayed fire alarm is the same as pressing a key at the keypad (the 90 second delay starts). Violation of a keyswitch zone arms or disarms the system. Violation of this zone type is NOT logged nor is the Police code transmitted. A bypass on this zone type will not be un-bypassed when the system is disarmed. When the zone is bypassed, a zone bypass event buffer log and communication occurs immediately, NOT when the system is armed.



- 23 Maintained Keyswitch Arm (Hardwired):** Keyswitch devices can be connected to zones programmed as Maintained Keyswitch arm. In the restored state, the panel is disarmed. Violation of the zone arms the panel. Tamper and faults begin their associated trouble sequence. If the system is armed with this keyswitch and then disarmed by another method, the keyswitch zone must be restored and then violated before the system can be armed with this zone again. The same is true for disarming. If the zone is restored and the system armed, the keyswitch zone must be violated and then restored to disarm the system.
- i** This zone type must NOT be used for wireless zones. Activation of a keyswitch zone is intended to arm or disarm the system. Activation of the zone will not log or transmit the Police code. A bypass on this zone type will not be un-bypassed when the system is disarmed. When the zone is bypassed, a zone bypass event buffer log and communication occurs immediately, NOT when the system is armed.
- With an audible alarm active, using the keyswitch when disarmed is the same as entering an access code at the keypad. Activating this zone type during the first 30 seconds of a delayed fire alarm is the same as pressing a key at the keypad (the 90 second delay starts). If left in the violated state, the system does not arm until the zone is restored and violated again.
- 24 Future Use**
- 25 Interior Delay Zone:** This zone type is normally used with motion detectors and has a standard exit delay time. If the panel is Away armed, the Interior Delay Zone is active at the end of the exit delay. The zone then acts like an interior type zone [04]. If the panel is Stay armed, a violation of this zone type initiates Entry Delay 1. Violating this zone during exit delay does not cause the system to arm in Away mode, as in regular delay type zones.
- 26 24 Hour Non-Alarm (or local alarm) Zone:** Zones programmed as this type are active at all times but do not cause an alarm and are not saved in alarm memory. Zone attributes such as Zone Bypassing and Door Chime affect the functionality of this zone.
- i** This zone type sounds the bell, but does not communicate during a walk test. Tamper and faults on zones programmed as 24-Hour non-alarm type do not cause alarms.
- 27-30 Future Use**
- 31 Day Zone:** Violating this zone when disarmed sounds the keypad buzzer but does not log or report the events. Violating this zone when armed sounds the bell and communicates the event.
- 32 Instant, Stay-Away Zone:** This zone is bypassed when the system is Stay armed, but it functions similarly to an Instant Zone [03] when Away armed. This zone type is useful for motion detectors that must NOT follow the entry delay after a delay zone is violated, but must still retain the Stay/Away functionality.
- 33-35 Future Use**
- 36 24-Hour Non-Latching Tamper Zone:** This zone generates a tamper condition when violated. This zone is active when armed or disarmed.
- 37 Night Zone:** This zone acts like an interior Stay/Away zone [05] when the panel is armed in any method except the following. When the system is armed in Stay mode and the interior zones are reactivated by the user entering [\*][1], this zone type will not be activated.
- 81 24-Hour Carbon Monoxide (CO) Detection:** This zone type is used with a wireless CO detector. This zone definition has a distinct bell cadence in the event of an alarm. The cadence of this alarm is 4 cycles of 100ms on/off pulses, followed by a 5-second pause, and then repeated. After 4 minutes the 5-second pause is extended to 60 seconds in duration. The bell is silenced when an access code is entered or the bell times out.
- 87 Delayed 24-Hour Fire (Wireless):** This zone is used with wireless smoke detectors. This zone functions similar to the standard 24 hour fire zone, except the alarm memory and transmission by the communicator is delayed 30 seconds. If the alarm is acknowledged by pressing any key within 30 seconds, the bells will silence and the transmission will be aborted. If the smoke detector is not restored after the alarm has been acknowledged the bell output will activate after 90 seconds. The user then has another 30-second delay before the bell output latches and communications are activated. A code is then required to silence the bell output. A tamper or fault of this zone type will cause a fire trouble to log and transmit.
- i** *The fire delay is terminated if a second fire zone is tripped or if the  key is pressed during a delay.*
- 88 Standard 24-Hour Fire (Wireless):** This zone is used with wireless smoke detectors. The bell output will sound instantly to indicate that the smoke detector has been activated when violated. If enabled, the communicator will immediately transmit the alarm to the monitoring station. A tamper or fault of this zone type will cause a fire trouble to log and transmit.
- i** *Zone attributes should NOT be changed from the default settings for all fire type zones.*

- 89 Auto Verified Fire Zone (Wireless) (Required for CP-01):** This zone type is to be used with wireless smoke detectors. This zone definition ensures an alarm condition persists by looking for a second alarm transmission or the absence of an alarm restoral condition. The system ignores subsequent alarm transmissions after the first transmission from the same zone for a duration of 40 seconds. If the sensor is in an alarm condition at the end of this 40-second delay, the system will go into full alarm, sounding the bell, logging and communicating the event. If the zone is in a restored condition at the end of the 40-second delay, the system will start another 80 second verification time sequence. If a fire zone goes into alarm during this period, the system will go into full alarm, sounding the bell, logging and communicating the event.

- i** *A tamper or fault of this zone type will cause a fire trouble to log and transmit.  
The wireless smoke detector that is used with this zone type must have a built-in siren to act as a pre-alert to the system alarm.*

**Multiple Fire Detections:** If another device detects fire during the auto verify or delay sequence, the sequence is immediately terminated and alarms are generated for all pending zones. This applies to all other fire zones or system  key alarms on the system (i.e., two fire alarms from different devices on the system will cancel all pending fire delays and create immediate alarms).

### [005] System Timers

After entering Section [005], program the Entry Delay 1, Entry Delay 2 and Exit Delay for the system. Entries are in seconds. Program the Bell Cut-Off Time. Valid entries are in minutes. A value of 000 in the entry or exit delay sections causes a 255 second delay. A value of 000 in the BTO section produces a 1 minute bell cut-off time. However, these times are displayed as 000.

### [006] Installer Code

The default Installer code is [5555] or [555555] if 6-Digit Access Codes is enabled.

### [007] Master Code

The master code is a system user code that can program additional access codes, [\*][5], and has access to additional user functions, [\*][6]. The default master code is [1234] or [123456] if 6-digit access codes are programmed. See section [701] Opt.[5].

### [008] Maintenance Code



The Maintenance Code is a system user code that can only arm and disarm. Any other system function that requires an access code is not accessible by this code. The default Maintenance code is [AAAA] or [AAAA00] if 6-digit access codes are programmed. See section [701] Opt. 5.

### [009] I/O Programming (PGM)

Enter the 2-digit PGM option while the I/O type is selected as PGM in section [013] option [1] & [2].

#### PGM Output Options:

- 00 Null PGM (Not Used)
- 01 **Burglary and Fire Bell Follower:** The PGM switches to ground when any bell activity occurs. This PGM type follows:
- Fire pre-alerts
  - CO (Carbon Monoxide) alarm signal
  - Temporal three fire signal (if enabled)
  - All burglary and fire alarms
  - Bell cut-off time
- This output does NOT follow bell squawks. The main bell still activates for all alarms.
- i** **Note:** The fire bell has precedence over burglary. If a fire alarm occurs when a burglary alarm is active, the fire and burglary output pulses (“Fire” PGM) with the main bell. This PGM type follows the bell (pulsed if fire, steady if burglary).
- 02-04 Future Use
- 05 **System Armed Status:** The PGM switches to ground at the beginning of the exit delay when the system is armed. The output goes high (open) when the system is disarmed.
- 06 **Ready to Arm:** The PGM switches to ground when the system is ready to arm (all non-force arm zones on the system are restored). When an access code is entered to arm the system and the exit delay begins, the PGM output is de-activated. This PGM operates as described during walk test mode (if all zones are restored).
- 07 **Keypad Buzzer Follow:** PGM output switches to ground when the keypad buzzer is activated by the events described below:
- 24-hour supervisory buzzer zone alarm
  - Entry delay
  - Audible exit delay
  - No activity arm pre-alert
  - Audible exit fault
  - Door chime
- The PGM output remains switched to ground while the keypad buzzer is active. This PGM type does not activate for local key presses or trouble beeps.
- 08 **Courtesy Pulse:** This PGM output switches to ground for 2 minutes past the end of entry or exit times to allow enough time for complete entry to or exit from the premises. If the system is armed through the *No Activity Arming* method this output will NOT activate.

- 09 **System Trouble:** This PGM output switches to ground when any of the selected Troubles are detected. The output de-activates when all of the selected Troubles are restored. The PGM attributes from this output are as follows:
- |   |                       |
|---|-----------------------|
| 1 Service Required                        | 5 Device (Fire) Fault |
| 2 A.C. Failure                            | 6 Device Tamper       |
| 3 Telephone Line Fault                    | 7 Device Low Battery  |
| 4 Communications (Failure to Communicate) | 8 Loss of Clock       |
- 10 **Latched System Event (Strobe):** This PGM output switches to ground when any of the selected system events (alarms) occur on the system. The PGM output deactivates when an access code is entered to disarm the system. If an alarm activates this output in the disarmed state, the alarm deactivates when a code is entered during bell time-out or if the system arms after bell time-out.
- Note:** This output activates for all silent and audible alarms.
- |               |  |
|---------------|--|
| 1 Burglary    | Delay, Interior Delay, Instant, Interior, Stay/Away, Instant Stay/Away, Night, Day Zone and 24-Hour Burg. zones    |
| 2 Fire        |  Key, Fire zone                   |
| 3 Panic       |  Key and Panic                    |
| 4 Medical     |  Key, Medical and Emergency zones |
| 5 Supervisory | Supervisory, 24-Hour Buzzer, Auxiliary, Freeze, and Water zones  |
| 6 Priority    | Gas, Heat, 24-Hour CO zones, 24-Hour Non-latching Tamper   |
| 7 Duress      | Duress alarms  |
| 8 Latched     | Follows output timer   |
- i Note:** This PGM output activates for alarm conditions only. Pre-alerts or delays do NOT activate the output. When this output follows the output timer, events that have been disabled from activating the output do not restart the timer.
- 11 **System Tamper:** This PGM output switches to ground when any Tamper condition occurs on the system. If set for steady operation, this output de-activates when all Tamper conditions on the system are restored. If this output is set for a pulsed output, the PGM output switches to ground when a Tamper condition occurs and remains on for the duration of the PGM output timer (programmed in section [170]). This activates for each Tamper condition, even if an un-restored Tamper condition is present on the system.  
Tampers include zone tamper (DEOL), alarm panel case tamper, TLM trouble, RF Jam, and all zone and device tampers.
- 12 **TLM and Alarm:** The output activates when a Telephone Line Trouble (TLM) condition is present and then an alarm occurs on the system.
- 13-16 Future Use
- 17 **Away Armed Status:** This PGM output follows the status of the Stay/Away zones. If the system is armed with the Stay/Away zones always active, then the Away output is active.
- 18 **Stay Armed Status:** This PGM output follows the status of the Stay/Away zones. If the system is armed with the Stay/Away zones bypassed, then the Stay output is active. Arming in Night mode activates this PGM output.
- 19 **Command Output #1:** Entering the [\*][7][1] command activates the PGM type according to how the PGM attributes are configured. Refer to sections [501] and [502] for attribute information.
- 20 **Command Output #2:** Entering the [\*][7][2] command activates the PGM type according to how the PGM attributes are configured. Refer to sections [501] and [502] for attribute information.
- 21-39 Future Use

## [012] Keypad Lockout Options

This section determines how the keypad function operates.

### Number of Invalid Codes Before Lockout

Program a number from 000 to 255 to determine the number of invalid master, user or installer access code entries to reach keypad lockout. When keypad lockout occurs, the system is rendered inoperative via the keypad for the programmed duration only (wireless keys and keyswitch zones still function). When any keys are pressed, an error tone sounds. Entering 000 disables keypad lockout.

### Lockout Duration

Program a time from 000 to 255 minutes to determine the length of time before lockout resets and the keypad can once again be used.

- If lockout is not reached within the hour roll-over, the number of invalid attempts is reset to 0.
- After a valid access code is entered, the number of invalid attempts is reset to 0.
- Fire, Auxiliary and Panic keys are still active during keypad lockout.
- Key presses do not reset the timer.
- If the lockout timer was active before powering down, the system lockout is active for the programmed duration on power up.

**[013] First System Options****Option Description**

- [1] **ON:** Hardwired Zone 33 Enabled. Hardwired Zone 33 Input is enabled. The I/O-1 terminal functions as an input for Zone 33. The zone definition is programmed in the first entry of section [003]. Zone supervision is determined by attributes 14, 15, and 16 programmed in section [133].  
**OFF:** PGM1 Output Enabled. The I/O-1 terminal functions as an output. the PGM type is programmed in the first entry of section [009]. PGM attributes are programmed in section [501].
- [2] **ON:** Hardwired Zone 34 Enabled. Hardwired Zone 34 Input is enabled. The I/O-2 terminal functions as an input for Zone 34. The zone definition is programmed in the first entry of section [003]. Zone supervision is determined by attributes 14, 15, and 16 programmed in section [134].  
**OFF:** PGM2 Output Enabled. I/O-2 terminal functions as an output. the PGM type is programmed in the first entry of section [009]. PGM attributes are programmed in section [502].
- [3]-[5] Future Use
- [6] **ON:** Audible Exit Fault Enabled. If a delay zone is not secured correctly and not force-armed, at the end of the exit delay, the system goes into entry delay and turns ON the bell output.  
**OFF:** Audible Exit Fault Disabled. The entry delay sounds through the keypad but not the bell.
- [7] Future Use
- [8] **ON:** Temporal Three Fire Signal Enabled. Temporal Three Fire Signal is used to annunciate fire alarms (½ second ON, ½ second OFF, ½ second ON, ½ second OFF, ½ second ON, 1 ½ seconds OFF).  
**OFF:** Standard Pulsed Fire Signal. The system pulses the bell output (1 second ON, 1 second OFF).

**[014] Second System Options****Option Description**

- [1] **ON:** Arm/Disarm Bell Squawk Enabled. The system squawks the bell output once when armed, twice when disarmed and 3 times when disarmed with alarms in memory.  
**OFF:** Arm/Disarm Bell Squawk Disabled. The bell output does not activate.
- [2] Future Use
- [3] **ON:** RF Jam Logs after 5 Minutes. The system logs an RF Jam trouble condition if the condition is present for 5 minutes.  
**OFF:** RF Jam Logs after 20 Seconds. The system logs the trouble condition after 20 seconds.
- i** The trouble is displayed on the keypad as soon as it occurs. The panel Trouble LED changes from yellow to orange indicating the presence of an RF jam.
- [4] **ON:** Aux Boost Enabled: When the system is in Power Save mode, (AC Trouble) Aux+ output voltage is regulated 12VDC.  
**OFF:** Aux Boost Disabled: Aux+ output voltage is not regulated.
- [5] Future Use
- [6] **ON:** Audible Exit with Urgency. The keypad beeps once every second, and 3 times a second during the last 10 seconds, during exit delay when the system is armed with a user code or armed in the Away mode. This option always on for CP-01.  
**OFF:** Silent Exit Delay. The keypad does not beep during exit delay.
- [7] Future Use
- [8] **ON:** Fire Bell is Continuous. The bell output does not time out if a fire alarm occurs. The User must turn off the bell by entering a valid user code.  
**OFF:** Fire Bell follows Bell Cut-off. The bell output times out normally.
- i** Only zone definitions [87], [88], and [89] (along with the [F] Key) use this signalling.

**[015] Third System Options****Option Description**

- [1] **ON:** Fire Key Enabled. Pressing and holding the fire  key for 2 seconds generates a fire alarm. The keypad sounds a set of 3 beeps to acknowledge the valid alarm and the buzzer sounds a pulsing alarm tone for the length of the bell time-out, or until an access code is entered. An alarm reporting code (if programmed) is transmitted.  
**OFF:** Fire Key Disabled. The Fire  key does not sound or report an alarm when pressed.
- i** *When enabled, this key generates alarms at all times.*
- [2] **ON:** Panic Key Audible. When a valid Panic key  alarm is generated, the keypad buzzer sounds a series of 3 beeps to acknowledge the alarm. The buzzer then sounds a steady tone for the length of the bell time-out or until an access code is entered.  
**OFF:** Panic Key Silent. When a valid Panic key  alarm is generated, the keypad buzzer and the bell output remain silent, but the alarm is still transmitted (if programmed).
- [3] **ON:** Quick Exit Enabled. See [\*][0] in section 3.3 [\*] Commands.  
**OFF:** Quick Exit Disabled.
- [4] **ON:** Quick Arming Enabled/Function Keys Do Not Require Code. [\*][0] arming and Stay/Away function keys may be used to arm the system without the entry of a valid access code. Wireless keys not associated to a user code may also be used.  
**OFF:** Quick Arming Disabled/Function Keys Require Code. [\*][0] arming is not permitted, and Stay/Away function keys require the entry of an access code to arm the system.
- i** *This option must be OFF to identify wireless keys for arming.*
- [5] **ON:** Code Required for Bypassing. After entering the [\*][1] Bypass Zones command, an access code must be entered before zones may be bypassed.  
**OFF:** No Code Required. No code is required to enter the [\*][1] Bypass Zones command to bypass zones.
- [6] **ON:** Master Code Not Changeable. The Master Code (access code 40) may not be changed by the user with [\*][5] access code programming. The Master Code can only be programmed in Installer Programming, section [007].  
**OFF:** Master Code Changeable. The Master Code (access code 40) may be programmed by the user using the [\*][5][Master Code][40] command. The Master Code may also be programmed in Installer Programming.
- [7] **ON:** TLM Enabled. The Telephone Line Monitor function is active and the system indicates if a Telephone Line Trouble condition exists when using the [\*][2] View Trouble Conditions command.  
**OFF:** TLM disabled. The Telephone Line Monitor function is shut off and telephone line troubles are NOT indicated by the system.
- [8] **ON:** System Tamper Enabled. The panel monitors the physical tamper switch. The switch activates if the system is taken off the wall, or the front cover is removed, generating a System Tamper Alarm. A system tamper causes an audible alarm if the system is armed. If the system is disarmed when a system tamper occurs, the system cannot be armed until the tamper condition is cleared.  
**OFF:** System Tamper Disabled. The panel does not monitor the physical tamper switch.

**[016] Fourth System Options****Option Description**

- [1] **ON:** Cross Zoning Enabled. The panel uses the Cross Zone attribute for burglary verification.  
**OFF:** Police Code Enabled. The panel uses the Police Code feature for burglary verification.
- [2] **ON:** Exit Delay Restart Enabled. (Only available on CP-01 panels) If a delay zone (Delay 1 or 2 only) is violated during the exit delay and then restored, it is considered an exit. If a delay zone is violated again it is considered a re-entry. With this option enabled the panel restarts the exit delay. Further violations and restores of delay zones do not restart the exit delay.  
**OFF:** Exit Delay Restart Disabled. Delay zone violations and restores do not restart the exit delay.
- i** *The exit delay can only be restarted once. This includes restarts from Away function keys. If the exit delay is silent, the additional exit time remains silent and doubles the programmed exit time (required for CP-01).*
- [3] **ON:** Blank Keypad When Not Used. If no keys are pressed for 30 seconds, the display and all keypad lights except back-lighting (if enabled) turn OFF until the next keypress, entry delay, audible alarm, or keypad buzzer condition.  
**OFF:** Keypad Always Active. The keypad lights remain ON at all times.
- [4] **ON:** Code required to remove Keypad Blanking. A valid access code must be entered before a blanked keypad can be used. If the bell or entry delay is active, entering an access code un-blanks the keypad and disarms the system.  
**OFF:** No Code Not Required. Pressing any key on a blanked keypad removes the blanking. If the key is a number, then it is considered the first digit of an access code.

- [5] **ON:** Keypad Backlighting Enabled. Keypad backlighting is continuously on.  
**OFF:** Keypad Backlighting Disabled. Keypad backlighting is never on.
- [6] Future Use
- [7] **ON:** Bypass Status Displayed While Armed. “*Warning Bypass Active*” displays if zones are manually bypassed when the system is Away armed.  
**OFF:** Bypass Status Not Displayed While Armed. Zones that have been manually bypassed are not indicated when the system is Away armed.
- [8] **ON:** Daylight Saving Time Enabled. The panel switches between daylight-saving and standard time according to the programmed time of the year and number of hours in sections [168] and [169].  
**OFF:** Daylight Saving Time Disabled. The panel will NOT make time adjustments for daylight-saving time.

### [018] Sixth System Options

#### Option Description

- [1] Future use
- [2] **ON:** Keypad Tamper Enabled. All system keypads generate tamper troubles and restores.  
**OFF:** Keypad Tamper disabled. System keypads do NOT generate tamper troubles and restores.
- [3]-[4] Future use
- [5] **ON:** Keypad Buzzer Follows Siren Enabled. The keypad buzzers follow the bell status.  
**OFF:** Keypad Buzzer Follows Siren Disabled. The keypad buzzers do NOT follow all bell activity. Only designated alarms will activate the keypad buzzer.
- [6]-[8] Future use

### [023] Tenth System Options

#### Option Description

- [1] **ON:** Chime on Openings Enabled. When a zone with the door chime attribute ON is violated, the system keypads and sirens (if enabled) sound door chime beeps.  
**OFF:** Chime on Openings Disabled. When a zone with the door chime attribute ON is violated, the system keypads and sirens (if enabled) do not sound door chime beeps.
- [2] **ON:** Chime on Closings Enabled. When a zone with the door chime attribute ON is restored, the system keypads and sirens (if enabled) sound door chime beeps.  
**OFF:** Chime on Closings Disabled. When a zone with the door chime attribute ON is restored, the system keypads and sirens (if enabled) do not sound door chime beeps.
- [3] **ON:** Test Transmission While Armed Only. The Test Transmission reporting code is only transmitted if the system is armed at the time it is programmed to report the event.  
**OFF:** Test Transmission while Armed/Disarmed. The system always reports the Test Transmission reporting code at the programmed time.
- [4] **ON:** Transmission Counter in Hours. The system changes the Test Transmission Reporting Cycle Time from Days to Hours.  
**OFF:** Transmission Counter in Days. The Test Transmission Reporting Cycle Time is in Days.
- [5] **ON:** Switching From Away to Stay Disabled. The user can NOT switch from Away Arm mode to Stay Arm mode using the function keys.  
**OFF:** Away to Stay Toggle Option Permitted. The user can switch arming modes.
- [6] **ON:** New Alarms will not Disconnect 2-way Audio. The system does not disconnect a listen in/two-way session if an alarm occurs.  
**OFF:** New Alarms Disconnect 2-way Audio. The system disconnects a listen in/two-way session. New events are transmitted after the session ends.

#### i

This option must be OFF for UL listed installations. Applies to SCW9057 only.

- [7] **ON:** Trouble Beeps are Silent. The system does NOT activate the keypad buzzer for any trouble condition except fire.  
**OFF:** Trouble Beeps Sound Every 10 Seconds. The system annunciates troubles via the keypad buzzer (2 beeps every 10 seconds).
- [8] **ON:** Keyswitch Arms in Away Only. Keyswitch zones on the system always arm in Away mode.  
**OFF:** Keyswitch Arms in Stay or Away. When a keyswitch zone is used to arm the system, the final armed mode depends on whether the user trips a delay zone during exit delay. If the user trips a delay zone, the system arms in Away mode; If not, the system arms in Stay mode. This is similar to arming the system at the keypad with an access code. The exit delay is audible.

**[024] Eleventh System Options Code****Option Description**

- [1] **ON:** Temperature Display Enabled. The keypad displays the temperature received from the lowest numbered external siren. If the local clock display is also enabled, then the keypad displays date, time, and temperature.  
**OFF:** Temperature Display Disabled. The keypad does NOT display the temperature.
- [2] **ON:** Temperature displayed in Celsius. The keypad displays the temperature in Celsius.  
**OFF:** Temperature displayed In Fahrenheit. The keypad displays the temperature in degrees Fahrenheit.
- [3] **ON:** Internal Siren Enabled. The internal siren on the panel is enabled.  
**OFF:** Internal Siren Disabled. The internal siren on the panel is disabled.
- [4] **ON:** Inactivity Monitored by all Zones. If no violations occur on any burglary zones during the Inactivity Timer windows (section [591]-[592]), the panel communicates the Fail to Report In code, if programmed.

**i** This code is not transmitted for panels that are Away armed. Troubles and bypassed zones will not cause activity indications.

**OFF:** Inactivity Monitored only by 24-hour Non-alarm Zones. If no violations occur on a 24-hour non-alarm zone during the Inactivity Timer windows (section [591]-[592]), the panel communicates the Fail to Report In code, if programmed.

- [5] **ON:** Enable Realtime Clock: The panel sends a request to the alternate communicator module for real time/date synchronization at midnight or when the panel clock time is lost. The updated time/date is displayed on the panel LCD.  
**OFF:** Disable Realtime Clock: The panel uses the local time setting as system time.

**i** This option must also be enabled in the alternate communicator. Please refer to the alternate communicator installation manual for more information.

[6]-[8] Future Use

**[030] Zone Loop Response Options**

This section is used to determine the Loop Response Time for hardwired zones 33 and 34.

**Option Description**

- [1] **ON:** Zone 33 is Fast Loop Response: Zone 33 has a fast loop response (36 ms).  
**OFF:** Zone 33 is Normal Loop Response: Zone 33 has a normal loop response (400 ms).
- [2] **ON:** Zone 34 is Fast Loop Response: Zone 34 has fast loop response (36 ms).  
**OFF:** Zone 34 is Normal Loop Response: Zone 34 has normal loop response (400 ms).

[3]-[8] Future Use

**[101]-[164] Zone Attributes**

The following options can be enabled or disabled for each zone. Pressing [9] in one of these sections brings the installer to the upper bank (attributes 9 to 16). From the upper bank, press [9] to return to the lower bank (attributes 1 to 8).

**i** These attributes override default settings. Do NOT change fire zone attributes from their default settings.

**Option Description**

- [1] Audible siren **ON:** An alarm activates the Siren.  
**OFF:** Silent alarm.
- [2] Steady or Pulsed-Bell Type **ON:** The bell output is steady when the zone is in alarm.  
**OFF:** The bell output pulses when the zone is in alarm.
- [3] Chime **ON:** The keypad chimes when the zone is violated and when the zone is secured.  
**OFF:** The zone does not chime the keypad.
- [4] Bypass **ON:** The zone may be manually bypassed.  
**OFF:** The zone can not be bypassed.
- [5] Force Arming **ON:** The system can be armed with the zone violated. The zone is temporarily bypassed and, when secured, is monitored by the system.  
**OFF:** The system cannot be armed if the zone is open.
- [6] Swinger Shutdown **ON:** When the zone goes into alarm for the number of times programmed in the Swinger Shutdown Counter (see section [377]), it shuts down with no further transmissions sent to the monitoring station. The bell follows Swinger Shutdown if programmed.  
**OFF:** Swinger Shutdown is disabled. All alarms are transmitted and do not follow the Swinger Shutdown Counter.
- i** If a zone is in Swinger Shutdown, and this attribute is disabled, then re-enabled, the zone will no longer be in Swinger Shutdown.
- [7] Transmission Delay **ON:** Reporting of zone alarms are delayed for the programmed time in section [377] after the zone goes into alarm. If a valid access code is entered within this time, no alarm signal is communicated.  
**OFF:** When an alarm occurs, the reporting code is transmitted immediately.
- [8] Cross Zone **ON:** The zone is enabled for cross zoning.  
**OFF:** The zone is not enabled for cross zoning.

- [9] 2-way Audio **ON:** The zone will initiate a 2-Way Audio Verification session with the Central Station.  
**OFF:** This zone will not initiate a 2-Way Audio session (applies to hardwired zones 33 & 34 only).
- [10] Talk-Listen/Listen-in Only **ON:** The zone initiates a 2-way session with the central station. Both microphone and speaker are activated. This option is only available when zone attribute [9] is enabled.  
**OFF:** The zone initiates a Listen-in only session with the central station. Only the microphone is activated. This option is only available when zone attribute [9] is enabled.

[11]-[13] Future Use

Options [14] to [16] are used for zones 33 and 34 exclusively. If more than 1 option is enabled for options 14, 15, and 16 the lowest attribute number will take precedence. If Options 14 and 15 are both enabled the zone follows the NC loop configuration.

- [14] Normally Closed Loops **ON:** The zone follows the Normally Closed (NC) loop configuration.  
**OFF:** The zone does NOT follow NC loop configuration.
- [15] Single End of Line (SEOL) Resistors **ON:** The zone follows the SEOL zone configuration.  
**OFF:** The zone does NOT follow SEOL zone configuration.
- [16] Double End of Line (DEOL) Resistors **ON:** The zone follows the DEOL zone configuration.  
**OFF:** The zone does NOT follow DEOL zone configuration.

**i** When Zone Types (section [001] to [002]) are programmed, the system changes the zone attributes to those found in the chart included in the Programming Worksheets. The Zone Attributes will default if a new Zone Type is programmed for a specific zone.  
Ready light On: Program attributes [1-8]  
Ready light and Armed light On: Program attribute [9-16] (press [1] for option 9, press [6] for option 14 etc.)  
Press [9] to switch between attributes [1-8] and attributes [9-16].

**[167] Alt. Comm. Communications Wait for ACK**

This value represents the time the communicator waits for an acknowledgement (ACK) from the receiver after sending the SIA or CID packet to the central station. If this timer expires before acknowledgement is received, the SCW re-transmits the Packet and increments the number of failed dialing attempts.

**[168] Daylight Saving Time Begin**

These sections are used to program the date, time and increment that the clock moves ahead for Daylight Saving Time each year. The following attributes can be programmed:

- Month [001] to [012] represents January to December.
  - Week [000] indicates that the day of the month is programmed in the Day section below. [001] to [005] represents weeks 1 to 5 of the month. Week 5 always represents the last week in the month, regardless of whether the number of weeks in the month is 4 or 5.
  - Day [001] to [031] represents the day of the month if [000] was programmed in the Week section above. If [001] to [005] was programmed in the Week Section above, then [000] to [006] represents Sunday to Saturday.
  - Hour [000] to [022] represents the hour that Daylight Saving Time takes effect.
  - Increment [001] to [002] represents the number of hours to advance the clock for Daylight Savings Time.
- i** Do not program the Hour outside of the valid range or the time will not change.  
Do not program the value of the Increment to be greater then the number of hours remaining in the current day.

**[169] Daylight Saving Time End**

These sections are used to program the date, time and increment that the clock moves back for Standard Time each year. The following attributes can be programmed:

- Month [001] to [012] represents January to December.
  - Week [000] indicates that the day of the month is programmed in the Day section below. [001] to [005] represents weeks 1 to 5 of the month. Week 5 always represents the last week in the month, regardless of whether the number of weeks in the month is 4 or 5.
  - Day [001] to [031] represents day of the month if [000] was programmed in the Week section above. If [001] to [005] was programmed in the Week Section above, then [000] to [006] represents Sunday to Saturday.
  - Hour [000] or [023] represents the hour that Standard Time takes effect.
  - Increment [001] or [002] represents the number of hours to roll back the clock for Daylight Saving Time.
- i** If Daylight Saving Time occurs at Midnight program the time 2:00AM.

**[170] PGM Output Timer**

Program the time, in seconds, PGM outputs programmed to follow the PGM Output Timer will activate for. Valid entries are [001] to [255].



**[176] Cross Zone/Police Code Timer**

Program the time, in seconds (Cross Zone) or minutes (Police Code), that the panel uses to determine if a Cross Zone or Police Code event has occurred. If [000] is programmed when using the Police Code feature, the panel generates a Police Code event (if any two zones go into alarm during an armed-to-armed period). Valid entries are [001] to [255].

**[190] No Activity Arming Pre-Alert**

Program the time, in minutes, for the No Activity Arming Pre-Alert Duration. The keypad provides a steady tone warning the user that the system is arming. The user can either violate a zone or press any key to abort the arming sequence. Valid entries are [000] to [255].  
**Note:** Not CP-01 compliant.

**[191] No Activity Arming Timer**

Program the time, in minutes, for the No Activity Arm Timer. If Delay Zones are restored and no zone activity is detected for the time programmed, the auto arm sequence starts. Valid entries are [000] to [255].  
**Note:** Not CP-01 compliant.

**[202]-[209] Zone Assignments**

Activates the selected zones. Zones 1-64 are ON by default. If a zone is enabled, it is supervised and operates according to the zone type programmed. If a zone is not assigned, it is not supervised and all activity on the zone is ignored by the panel.

- i** If a zone assignment is set, but no serial number is enrolled (zones 1 to 64), or the terminals are set as PGM outputs instead of zone inputs (zones 33 and 34), then these zones appear in the bypass list.

**[301]-[303] Communication Telephone Numbers**

The information in this section also applies to sections [302], [303] and [305].

These sections determine which type of communicator is activated in the event of an alarm (telephone, Cellular and Ethernet) and the sequence that the system follows in the event of an unsuccessful communication.

- Entry of [D] followed by a [Telephone Number] terminated with “F” configures the section for telephone dialing.  
 E.g.: [D12223334444F]
- Entry of [D] followed by [CAA] terminated with “F” allows the system configuration to be determined by the alternate communicator module.  
 E.g.: [DCAAF]
- Enter [DCBBF] to configure the section for Ethernet Receiver 1
- Enter [DCCCF] to configure the section for Ethernet Receiver 2
- Enter [DCDDF] to configure the section for Cellular Receiver 1
- Enter [DCEEF] to configure the section for Cellular Receiver 2

**Telephone Communications**

All telephone number sections are 32 digits in length. Hexadecimal digits may be programmed in the telephone number to perform additional functions as follows:

- Enter [\*][2][\*] – HEX B to dial “\*”
- Enter [\*][3][\*] – HEX C to dial “#”
- Enter [\*][4][\*] – HEX D for an additional dial tone search, as is required for PBX telephone systems
- Enter [\*][5][\*] – HEX E to insert a 2-second pause in the telephone number

- i** There is an automatic 2-second pause before additional dial tone searches are initiated.

HEX A is not used.

HEX F represents the end of the phone number (everything after F is ignored).

Pressing [#] in these sections exits and saves the entire phone number.

The panel does not attempt to communicate if no phone number is programmed. This applies to phone numbers 1 and 2.

**[304] Call Waiting Cancel String**

Program the digits required to disable call waiting. If enabled, the system dials the programmed string on the first dialing attempt. Program unused digits with data [F]. This section is activated in Section [382] Opt [4].

**[305] Fourth Telephone Number**

See [301]-[303] Communication Telephone Numbers for details.

**[310] System Account Number**

Program the System Account Number. Only the SIA format supports 6-digit account numbers. If a 4-digit account number is required, program the last two digits as data [FF]. For formats other than SIA, program a HEX [A] for any digit [0] in the account number being used.

**Auto Sync with Alternate Communicator**

If the panel detects an alternate communicator module, it automatically synchronizes the system account code with programming section [021] of the alternate communicator. Account codes of FFFFXX and 0000XX are not permitted. Synchronization takes place when Installer Programming is exited or DLS disconnects.

### **[320]-[327] Alarm Reporting Codes**

These reporting codes are used by the communicator to transmit zone alarms and restores for zones 1 to 64. These reporting codes are sent to the Alarm & Restore call direction group.

- i** Zone alarms transmit to the System Test Transmission Call Direction when they are being transmitted as part of the walk test (enabled if section [382] option [2] is ON).

### **[328] Miscellaneous Alarm Reporting Codes**

#### **Duress Alarm**

This reporting code is transmitted whenever a Duress code is used to perform any function on the system. The reporting code is sent to the Alarm & Restore call direction group.

#### **Opening After Alarm**

This reporting code is transmitted when the system is disarmed after an alarm; if an alarm occurred during the previous armed period. The reporting code is sent to the Alarm & Restore call direction group.

#### **Burglary Not Verified**

When Cross Zoning (section [016] option [1]) is enabled, this reporting code is sent if the Cross Zone timer is initiated by the first cross zone alarm, but it is not verified by a second cross zone alarm before the timer expires. This reporting code is sent to the Alarm & Restore call direction group.

#### **Alarm Cancelled**

If an alarm event is sent after transmission delay has expired, a cancel window time starts. This event is logged and transmitted if a valid access code is entered any time during this window. When this reporting code/event has been acknowledged by the central station, a keypad will ring back. This reporting code is sent to the Alarm & Restore call direction group. See section [377] Communications Cancel Window.

### **[329] Priority Alarm and Restore Reporting Codes (Fire, Auxiliary, Panic Alarms/Restores and Fail to Report In)**

If enabled and used to generate manual alarms, these reporting codes are sent to the Alarm & Restore Call Direction group.

### **[330]-[337] Tamper/Restore Reporting Codes, Zones 01-64**

These reporting codes are used by the communicator to transmit zone tamper and restores for zones 1 to 34. These reporting codes are sent to the Tamper Alarm & Tamper Restore call direction group of the system.

### **[338] Miscellaneous Tamper Reporting Codes**

#### **General System Tamper & Restore**

These reporting codes are sent to the system Tamper Alarm & Tamper Restore call direction group when a panel tamper occurs.

#### **Keypad Lockout**

Whenever the system enters keypad lockout, this reporting code is sent to the system Tamper Alarm & Tamper Restore call direction group.

### **[339] Closing (Arming) Reporting Codes (Access Codes 1-16)**

When the system is armed, a closing reporting code is transmitted after the exit delay expires for the user code that armed the system. These reporting codes are sent to the Opening & Closing call direction group of the system. In addition, either "Armed in Stay Mode" or "Armed in Away Mode" is logged to the event buffer.

#### **Closing by Users (Duress)**

When the system is armed by an access code programmed as duress, the corresponding closing reporting code is transmitted. This reporting code is sent to the Opening & Closing call direction group.

### **[341] Miscellaneous Closing (Arming) Reporting Codes**

#### **Closing By Master Code 40**

See [339] Closing by Users 1-16.

#### **Automatic Zone Bypassing**

This stops transmission of zone bypass information for systems set up for an automatic communication format (SIA and Contact ID). Enter [00] to disable the automatic zone bypassing communications. If the zones are to be identified, they are transmitted with the Partial Closing to the Opening & Closing call direction group. (24 Hour zone types transmit that they have been bypassed when the user exits the bypassing menu).

#### **Partial Closing**

If zones were manually bypassed at the time of arming, this reporting code is transmitted to the central station with the Closing code to warn of a security compromise. Automatic bypasses caused by Stay arming do not cause this code to be transmitted. Zones force armed by automatic arming transmit in the manner described above. If SIA is used, each zone is identified using the UB-XX (un-typed bypass) identifier. The identified zones follow the partial closing code and precede the closing transmission. This reporting code is sent to the Opening & Closing call direction group.

#### **Special Closing**

This reporting code is transmitted if the system is armed without an access code using Keyswitch Zone, Downloading, Quick Arm [\*][0], or Stay or Away function keys. In addition, either "Armed in Stay Mode" or "Armed in Away Mode" is logged to the event buffer for all closing types. This reporting code is sent to the Opening & Closing call direction group.

**Exit Fault**

If an Exit Error occurs and entry delay expires before the system is disarmed, this reporting code is sent. This reporting code is sent to the Openings & Closings call direction group.

- i** If the delay zone that caused the exit error has cross zoning enabled, the exit fault and zone alarm still transmit if a second zone is not violated. This is to inform the central station that the premise is not secure. The local alarm sequence follows the cross zoning rules. The exit error is transmitted with the zone alarm that caused the fault, even if that zone has a transmission delay enabled.

**[342] Opening (Disarming) Reporting Codes (Access Codes 1-16)**

When the system is disarmed, an opening Reporting code for the corresponding user is transmitted. These reporting codes are sent to the Opening & Closing call direction group.

**Opening by Users (Duress)**

An opening by an access code programmed as duress results in a transmission of the corresponding opening reporting code. These reporting codes are sent to the Opening & Closing call direction group.

**[344] Miscellaneous Opening (Disarming) Reporting Codes****Opening By Master Code 40**

See [342] Opening (Disarming) by Users 1-16.

**Special Opening**

If the system is disarmed (opened) by using keyswitch zone, an unidentified wireless key, or downloading, this reporting code is transmitted to the Opening & Closing call direction group.

**[345]-[346] Maintenance Alarm Reporting Codes****Battery Trouble & Restore**

This trouble is reported if the standby battery is low or disconnected. These reporting codes are sent to the System Maintenance call direction group.

**AC Failure Trouble & Restore**

If the AC supply has failed or has been restored, these reporting codes are sent. A programmable delay (001-255 minutes, section [377]) applies to both the trouble and the restore. These reporting codes are sent to the System Maintenance call direction group.

**Fire Trouble & Restore**

An open circuit or any Low Sensitivity, Tamper or Fault report from a wireless smoke detector, causes this trouble to be reported. These reporting codes are sent to the System Maintenance call direction group.

**Auxiliary Power Supply Trouble & Restore**

If an auxiliary voltage supply trouble occurs (the Aux PTC has caused the auxiliary supply to stop outputting power), this trouble is reported within 60 seconds. These reporting codes are sent to the System Maintenance call direction group.

- i** When the Aux Positive Temperature Co-efficient (electronic fuse) enters the open state due to a short or high current draw, if the short is removed and a load is still applied, the Aux+ output will not recover. It must be powered down and back up again to restore this condition.

**TLM Alarm**

The TLM Restore code is sent when the telephone trouble condition is restored. This reporting code is sent to the System Maintenance call direction group.

**General System Trouble & Restore**

These reporting codes are transmitted via System Maintenance call direction group to report RF Jam troubles or hardware fault troubles that occur on the system.

**General System Supervisory Trouble & Restore**

These reporting codes are transmitted via the System Maintenance call direction group when an enrolled TLXXX module has been detected as absent or restored.

**System Reset (Cold Start)**

In the event of a total power failure, the Cold Start reporting code is transmitted to the central station when power is restored to the panel. The reporting code is sent after 2 minutes to allow the panel to stabilize, although the event is logged in the buffer at 00:00. An entry of 00 in this section disables the reporting code.

**[347] Miscellaneous Maintenance Reporting Codes****Failure to Communicate (Phone Numbers 1, 2, 3 & 4)**

When events fail to communicate to either telephone number, this reporting code is transmitted the next time a communication is successful. The information is transmitted in the following order:

- Old Event(s)
- Failure To Communicate (Phone #1)
- New Event(s)

The FTC reporting code does not follow any call direction "group." It is sent to every group's call directions upon transmission of "failed to communicate" events. When event(s) fail to communicate to a telephone number, no attempt to communicate is made again until another event is sent to that phone number.

### DLS Lead In and Lead Out

When call-back is enabled, the control panel transmits the DLS Lead In reporting code before calling back the downloading computer. The DLS Lead Out reporting code is transmitted by the panel every time DLS has completed a successful DLS session with the control panel. The DLS Lead In reporting code is transmitted in two ways: after the panel has been successfully called by DLS, but before the panel calls DLS back via the downloading telephone number when call-back is enabled, or upon a user-initiated call-up. These reporting codes are sent to the System Maintenance call direction group.

- i** If DLS is terminated by an alarm, the alarm system will not communicate the DLS lead out event.
- i** DLS Lead In/Lead Out reporting codes must be programmed as 00 (not communicated) if the DLS connection uses a separate APN than used for alarm transmissions.

### General Zone Fault & Restore

This reporting code is sent whenever a zone has entered the fault state. This occurs when there is a short on DEOL hardwired zones and/or a loss of supervisory on a wireless zone. These reporting codes are sent to the System Maintenance call direction group.

### Panel Firmware Update Begin/Successful

This reporting code is sent to the central station before the panel starts a firmware upgrade and after it has been successfully completed.

### Delinquency Reporting Code

The Delinquency Reporting code is transmitted in one of two ways. If section [380] option [8] is OFF, it is transmitted when the system has not been armed for the number of days programmed in section [377]. If section [380] option [8] is ON, it is transmitted when no zone activity has been detected on the system for the number of hours programmed in section [377]. This reporting code is sent to the System Maintenance call direction group.

- i** The Activity Delinquency timer is active when the system is armed in Stay mode, and not active in Away mode or Night mode arming.

### General Zone Low Battery Alarm and Restore Codes

The following reporting codes are sent to report a Zone Low Battery condition on wireless zones. Individual zones are logged to the event buffer. SIA and Contact I.D. formats identify the zone with the low battery condition. A zone low battery trouble is displayed immediately. Transmission may be delayed (section [377]). These reporting codes are transmitted to the System Maintenance call direction group.

### Installer Lead In and Lead Out

The Installer Lead In and Lead Out reporting codes are sent when the panel enters and exits Installer Programming respectively.

### [348] Test Transmission Reporting Codes

#### Walk Test Begin/End

These reporting codes are sent when the walk test is initiated and terminated. These codes precede and terminate the alarm reporting codes for the zones that are activated during the walk test period, if the alarms are to be transmitted (section [382] option [2]). The walk test reporting codes are sent to the System Test Transmission call direction group.

#### Periodic Test Transmission

When the programmed interval and time of day have elapsed, this reporting code is transmitted. This reporting code is sent to the System Test Transmission call direction group.

#### System Test

When the [\*][6][Master Code][4] command is used to perform a manual system test, this reporting code is sent to test the communicator. This reporting code is sent to the System Test Transmission call direction group.

### [350] Communications Format Options

This section requires four 2-digit entries (1 per phone number). See Appendix B: Communicator Format Options.

- i** If phone numbers are programmed for use with the alternate communicator modules, the programmed format must be SIA or Contact ID.

### Auto Sync with Alternate Communicator Module

If the panel detects an alternate communicator module, it automatically writes the communications format programmed in this section (03 contact ID or 04 SIA) to programming section [022] of the alternate communicator module. If a communications format has not been programmed for phone numbers 1-4, 04 (SIA) is written to the alternate communicator module by default. If both SIA and Contact ID are programmed, Contact ID is written to the alternate communicator module. Synchronization takes place when Installer Programming is exited or DLS disconnects.

### [351]-[376] Communicator Call Direction Options

Communicator call directions can be configured for 4 different phone numbers. Each reporting code falls under one of the following 5 groups:

- Alarms & Restores
- Openings & Closings
- Tamper & Restores (including System Tamper)
- System Maintenance Alarms & Restores
- System Test Transmissions

Each group can be assigned to the following call directions:

- Option 1: 1<sup>st</sup> Telephone Number
- Option 2: 2<sup>nd</sup> Telephone Number

Option 3: 3<sup>rd</sup> Telephone Number

Option 4: 4<sup>th</sup> Telephone Number

### [377] Communicator Variables

Program a 3-digit number for each program entry:

**Swinger Shutdown (Alarms):** Maximum number of alarm/restore transmissions per zone. Valid entries: [000] to [014]. Program data [000] to disable shutdown.

**Swinger Shutdown (Tamper):** Maximum number of tamper alarm/restore transmissions per zone. Valid entries: [000] to [014]. Program data [000] to disable shutdown.

**Swinger Shutdown (Maintenance):** Maximum number of trouble alarm/restore transmissions per trouble condition. Valid entries: [000] to [014]. Program data [000] to disable shutdown.

**Communicator (Transmission) Delay:** Time, in seconds, panel delays reporting an alarm event. Valid entries: [000] to [255].

**AC Failure Communication Delay:** Time in minutes or hours, panel delays reporting an AC trouble event or restore.

**Note:** AC Restore communications follow the same delay.

**TLM Trouble Delay:** Time, in 3 second checks, before the system considers the phone line disconnected. Valid entries: [003] to [255] (e.g., 3 x 3 seconds = 9 seconds).

**Note:** TLM Restore follows the same delay.

**Test Transmission Cycle (Land Line):** Number of days or hours between test transmission reporting events. Valid entries: [001] to [255]. [000] disables the Test Transmission.

**Wireless Device Low Battery Delay:** Number of days the system delays reporting a wireless low battery to the central station. Valid entries: [000] to [255]. Program data [000] for no delay.

**Delinquency Transmission Delay:** Number of hours (Activity Delinquency) or days (Arming Delinquency) the panel delays before transmitting the event to the central station. Valid entries: [001] to [255].

**Communication Cancelled Window (CP-01 only):** Time, in minutes, after an alarm has occurred that the system reports a Communication Cancel reporting event if the system is disarmed. The keypad displays "Communication Cancelled" to indicate that the communication cancelled reporting event has been successfully sent to the monitoring station. Valid entries: [005] to [255].

### [378] Test Transmission Time of Day

Program the time the system will report a Test Transmission reporting event. Program 4 digits – [HHMM] using military standard. For a test transmission at 11:00 pm, program data [2300]. Valid entries are [0000] to [2359], [9999] to disable.

### [380] First Communicator Options

#### Option Description

- [1] **ON:** Communications Enabled. The system communicator is enabled.  
**OFF:** Communications Disabled. The communicator is disabled.
- [2] **ON:** Restores on Siren Time-out. The system transmits alarm Restores if the zone is restored and the bell has timed out.  
**OFF:** Restores Follow Zones. The system transmits alarm restores immediately when the zone is restored.
- [3] **ON:** Pulse Dialing. The panel uses rotary (pulse) dialing.  
**OFF:** DTMF Dialing. The panel uses touchtone (DTMF) dialing.
- [4]-[5] Future Use
- [6] **ON:** Alternating Backup Dialing Enabled. The communicator switches to the next backup number in the sequence after each failed dialing attempt. This continues until communications are successful or the sequence has been repeated 5 times.  
**OFF:** Call Primary Number, Backup to secondary. If 5 attempts to communicate to the primary telephone number fail, the communicator switches to the next backup and makes up to 5 more attempts. If communications failure continues the communicator will attempt the second and third backup numbers if designated.
- [7] Future Use
- [8] **ON:** Delinquency Follows Zone Activity (Hours). The Delinquency feature follows zone activity.  
**OFF:** Delinquency Follows Arming (Days). The Delinquency feature follows arming.

**[381] Second Communicator Options****Option Description**

- [1] **ON:** Opening After Alarm Keypad Ringback Enabled. When the Opening After Alarm reporting code is successfully transmitted to a programmed telephone number, the keypad sounds a series of 8 beeps to confirm to the end user that the Opening After Alarm Code was sent and received. This Ringback occurs for each Opening After Alarm code successfully reported.  
**OFF:** Opening After Alarm Ringback Disabled.
- [2] Future Use
- [3] **ON:** SIA Uses Programmed Reporting Codes. The system uses programmed reporting codes when transmitting using the SIA format.  
**OFF:** SIA Uses Automatic Reporting Codes. The system automatically generates all reporting codes transmitted.
- [4] **ON:** Closing Confirmation Enabled. The system beeps the keypad 8 times after successfully transmitting a Closing reporting event.  
**OFF:** Closing Confirmation Disabled. The keypad does not beep.
- [5]-[6] Future Use
- [7] **ON:** Contact ID Uses Programmed Reporting Codes. The system uses Contact ID format programmed reporting codes when transmitting reporting codes.  
**OFF:** Contact ID Uses Automatic Reporting Codes. The system automatically generates all reporting codes transmitted.
- [8] Future Use

**[382] Third Communicator Options****Option Description**

- [1] Future Use
- [2] **ON:** Alarm Communications Enabled During Walk Test. The system transmits all alarms during Walk Test.  
**OFF:** Alarm Communications Disabled During Walk Test. The system does not report alarm events during Walk Test.
- [3] **ON:** Communications Cancelled Message Enabled. The keypad displays the message “Communications Cancelled” upon successful transmission of the Communication Cancelled reporting event.  
**OFF:** Communications Cancelled Message Disabled. The keypad does not display these messages. (ON for SIA CP-01).
- [4] **ON:** Call Waiting Cancel Enabled. The system dials the Call Waiting Cancel string on the first attempt to dial the central station.  
**OFF:** Call Waiting Cancel Disabled. The system does not dial the Call Waiting Cancel string.
- [5] **ON:** Alternate Communicator Module Enabled. This option enables supervision of the Cellular/Ethernet communicator. This option must be ON to allow communications through the Cellular/Ethernet communicator.  
Note: When this option is OFF, Installer Programming sections [850]-[851] are not accessible.  
**OFF:** Alternate Communicator Module Disabled. The panel will not attempt to supervise the Cellular/Ethernet communicator. When this option is OFF the Cellular/Ethernet communicator is disabled.
- [6] **ON:** AC Failure Transmission Delay in Hours. The System AC Failure Communication Delay in section [377] is programmed in hours.  
**OFF:** AC Failure Transmission Delay in Minutes. The System AC Failure Communication Delay in section [377] is programmed in minutes.
- [7] **ON:** Number of Dialing Attempts is 1 for Residential Dial. Number of Dialing Attempts is one when using Residential Dial communication format.  
**OFF:** Residential Dialing Attempts is 5. Number of Dialing Attempts is five when using Residential Dial communication format.
- [8] Future Use

**[383] Fourth Communicator Options Code****Option Description**

- [1] Future Use
- [2] **ON:** Phone number 2 Backs Up Phone number 1. Phone number 2 backs-up phone number 1 if phone number 1 fails to communicate (FTC). Phone number 2 communicates in the same format as phone number 1.  
**OFF:** Phone number 2 is Independent. Phone number 2 does NOT back up phone number 1. Events are communicated to phone number 2 (if enabled in Communicator Call Direction, section [351]-[376]), using the communicator format programmed in section [350].
- [3] **ON:** Phone number 3 Backs up number 2. Phone number 3 backs-up phone number 2 if phone number 2 fails to communicate (FTC). Phone number 3 communicates in the same format as phone number 2.  
**OFF:** Phone number 3 is Independent. Phone number 3 does NOT back up phone number 2. Events are communicated to phone number 3 (if enabled in Communicator Call Direction, section [351]-[376]), using the communicator format programmed in section [350].

- [4] **ON:** Phone number 4 Backs up number 3. Phone number 4 backs-up phone number 3 if phone number 3 fails to communicate (FTC). Phone number 4 communicates in the same format as phone number 3.  
**OFF:** Phone number 4 is Independent. Phone number 4 does NOT back up phone number 3. Events are communicated to phone number 4 (if enabled in Communicator Call Direction, section [351]-[376]), using the communicator format programmed in section [350].
- [5] **ON:** FTC'ed Events Communicate. The panel transmits Failure to Communicate (FTC) events if the digital communicator is unsuccessful in communicating with any of the programmed telephone numbers. The FTC trouble/restore reporting code is transmitted via the corresponding event call direction.  
**OFF:** FTC'ed Events Do Not Communicate. FTC events are not transmitted. FTC trouble/restore reporting codes are transmitted via the Maintenance call direction group after the next successful transmission.
- [6] **ON:** Account Code Error Check Enabled. Enabling this option ensures that a new account code is programmed. Upon attempting to exit Installer Programming, the panel checks if a phone number is programmed in sections [301], [302], [303] and [305]. If a phone number is programmed in any of these sections, the panel checks if the format is residential dial in section [350]. If the format is residential dial, the check process is aborted. If the format is anything but residential dial, the panel checks that the system account code has been changed from the default (FFFFFF) or has been programmed with an invalid entry (0000XX or FFFFXX).  
If the account code has not been programmed when the installer attempts to exit Installer Programming:
  - The system turns on the trouble LED and sounds an error tone for 5 seconds.
  - The prompt "Account Code Not Programmed[\*]" is displayed on the keypad.
  - When the 5-second error tone expires, the system automatically enters installer programming section [310] so the account code can be programmed.
If the account code has been programmed, the panel operates normally.  
**OFF:** Account Code Error Check Disabled. The account code is not checked when exiting Installer Programming.
- [7] Future Use
- [8] **ON:** Remote notification format is SIA. The panel sends SMS or other remote notifications to the communicator in SIA format.  
**OFF:** Remote notification format is CID. The panel sends SMS or other remote notifications to the communicator in Contact ID format.

### [389] Alternate Communicator Fault Check Timer

The programmed number of poll commands that must be sent without valid poll responses before the panel generates a trouble condition. The number of valid checks happen at 3-second intervals. After the time-out an Ethernet or Cellular fault trouble is generated. Valid entries are 003-255 for trouble annunciation and transmission. The trouble restore is delayed in the same manner as well.

### [401] First Downloading Options

#### Option Description

- [1] **ON:** Answering Machine/ Double Call Enabled. The system answers incoming calls for downloading (either Programmed Number of Rings or Double Call).  
**OFF:** Answering Machine/ Double Call Disabled. The system does not answer incoming calls for double call attempts, but still answers on Programmed Number of Rings.  
These settings do not affect the 6 hour DLS downloading window on power up.
- [2] **ON:** User Can Enable DLS Window. The user can enable downloading for the DLS downloading window (double call only) using the [\*][6] command.  
**OFF:** User Cannot Enable DLS Window. The user can not enable the DLS window using the [\*][6] command.
- [3] **ON:** Call Back Enabled. The system hangs up after a successful DLS connection and calls the computer back using the DLS Phone Number (Section [402]).  
**OFF:** Call Back Disabled. The system stays connected to the computer.
- [4] **ON:** User Initiated Call-up Enabled. The user can initiate a downloading session using the [\*][6] command.  
**OFF:** User Initiated Call-up Disabled. The user cannot initiate a downloading session.
- [5] Future Use
- [6] **ON:** 300 Baud Panel Call-Up. When the user initiates a DLS connection, the panel connects and sends the initial header at 300 baud.  
**OFF:** 110 Baud Panel Call-Up. When the user initiates a DLS connection, the panel connects and sends the initial header at 110 baud. The panel then switches to 300 baud in order to receive the response from the DLS computer.
- [7] Future Use
- [8] **ON:** Alternate Communicator DLS Always. When this feature is enabled, the SCW9055/57 responds to DLS requests through the Alternate Communicator IP or Cellular paths at any time regardless of whether the DLS window is active or not. Note: If an incorrect DLS Access Code is entered 5 times in a row when trying to establish a connection, the panel locks out the alternate communicator DLS access until the next hour roll-over.  
**OFF:** Alternate Communicator Follows DLS Window. When this feature is disabled, the SCW9055/57 only responds to DLS requests through the alternate communicator IP or Cellular paths when the DLS window is active. The DLS window is active following a power up of the control panel, or when the user enables it by pressing [5] while in the [\*][6] User Functions menu.

**[402] DLS Downloading Computer's Telephone Number**

The Downloading Computer Telephone Number is used for Call Back and User Initiated DLS functions. Program the phone number as required. HEX digits can be included for special applications:

HEX [A]	Not used
HEX [B]	Simulates a [*] key press
HEX [C]	Simulates a [#] key press
HEX [D]	Additional dial tone search
HEX [E]	2-second pause
HEX [F]	End of phone number marker

**[403] DLS Downloading Access Code**

Program the 6-digit Downloading Access Code. Upon connection, the system only connects to the downloading computer if the Downloading Access Code programmed matches the Downloading Access Code programmed in the computer file.

**Note:** The DLS Downloading Access Code must be changed from its default value.

**[404] Panel ID Code**

Program the 6-digit Panel Identification Code. This code is used by the downloading computer to verify the correct account is calling back (Call Back feature) or to identify which customer account file should be used (User Initiated DLS features).

**[405] Double Call Timer**

Program the maximum time in seconds, between calls, when connecting to the panel using the Double Call feature.

**[406] Number of Rings to Answer On**

The value in this section determines how many rings the panel will automatically pick up on in order to establish a DLS connection.

- i** If Section [401] Option 1 and Section [406] are both enabled, either one works depending on how the installer calls the premises.

**[501]-[502] PGM Output Attributes**

Allows the installer to customize PGM1 and PGM2 Attributes. The following attributes can be enabled or disabled for each PGM output. When a PGM option is changed, the corresponding PGM's attributes are defaulted.

**Option Description**

The following attributes are available for PGM Output Types [01], [05]-[08] and [17]-[18]

[1]-[2] Future Use

[3] Output Level

**ON:** Output activates (switch to Ground) when the event occurs.

**OFF:** Output de-activates (switch to open) when the event occurs.

[4] Output Options

**ON:** Output Pulsed. When using [\*][7], the output activates for the duration programmed in the PGM output timer, section [170].

**OFF:** Output On/Off. The output toggles between on and off when the corresponding [\*][7] command is entered.

The following attribute is available only for PGM Output Types [11] and [19]-[20].

[5] Access Code Options

**ON:** Access code required for activation.

**OFF:** No access code required for activation.

The following attributes are available for the System Trouble PGM option [09]

System Trouble PGM (Type 09)

[1] Service Required

[2] A.C. Failure

[3] Telephone Line Fault

[4] Communications (Failure to Communicate)

[5] Device (Fire) Fault / WLS Zone Supervisory Fault Enabled

[6] Device Tamper

[7] Device Low Battery

[8] Loss of Clock



The following attributes are available for the System Event PGM option [10]

System Event PGM (Type 10)

[1] Burglary	Delay, Instant, Interior, Stay/Away, Night, and 24 Hour Burglary Zone Types
[2] Fire	<input type="checkbox"/> Key, Fire zone
[3] Panic	<input type="checkbox"/> Key and Panic zones
[4] Medical	<input type="checkbox"/> Key, Medical, and Emergency zones
[5] Supervisory	Supervisory, Auxiliary, Freeze, and Water zones
[6] Priority	Gas, CO, 24-Hour Heat and 24-Hour non-Latching Tamper zones
[7] Duress	Duress alarms
[8] Output Options	<b>ON:</b> Output Follows PGM Timer (Attribute 8). The output activates for the duration programmed for the PGM output timer (section [170]) <b>OFF:</b> Output is Latched. The output is active until a valid access code is entered.

- i** If a system event PGM is programmed to follow the command output timer (Attribute 8 On), all other PGM attributes must be enabled.

### [591]-[592] Inactivity Timers 1 & 2 Start and End Times

Inactivity timers are used to create two windows to monitor 24-Hour, non-alarm zone activity. They are [591] Inactivity Timer 1 Start, Inactivity Timer 1 End, [592] Inactivity Timer 2 Start, and Inactivity Timer 2 End. Enter two 4-digit decimal numbers in these two sections. Valid entries for each 4-digit decimal entry are 0000 to 2359. Enter 9999 to disable. The Failed to Arm reporting code follows the alarms and restores call directions.

### [600] 2-way Audio Control Options 1 (applies to SCW9057 only)

**Option Description**

- [1] **ON:** Tamper Enabled. The Talk/Listen-in session initiates for tamper conditions.  
**OFF:** Tamper Disabled. 2-way Audio is disabled for tamper conditions.
- [2] **ON:** Openings and Closings Enabled. The Talk/Listen-in session initiates for Openings & Closings events.  
**OFF:** Openings and Closings Disabled. 2-way Audio is disabled for Openings & Closings events.
- [3] **ON:** [A] Key Alarm Enabled. The Talk/Listen-in session initiates for [A] Key Alarm.  
**OFF:** [A] Key Alarm Disabled. 2-way Audio is disabled for [A] Key Alarm.
- [4] **ON:** [P] Key Alarm Enabled. The Listen-in session initiates for [P] Key Alarm if the [P] Key is programmed to be Silent. If the [P] Key is programmed to be audible, the 2-way audio session will be Talk/Listen-in.  
**OFF:** [P] Key Alarm Disabled. 2-Way Audio is disabled for [P] Key Alarm.
- [5] **ON:** Duress Alarm Enabled (Listen). The Listen-in session initiates for Duress Alarm.  
**OFF:** Duress Alarm Disabled. 2-Way Audio is disabled for Duress Alarm.
- [6] **ON:** Opening after Alarm Enabled. The Talk/Listen-in session initiates for Opening After Alarm.  
**OFF:** Opening after Alarm Disabled. 2-Way Audio is disabled for Opening After Alarm.
- [7] **ON:** Siren Active during 2-way Audio Verification. The sounder will remain active during a 2-way Audio session when an audible alarm is present  
**OFF:** Siren Silent during 2-way Audio Verification. The sounder will be silent when a 2-Way Audio session begins when an audible alarm is present, allowing the user to hear the operator. The sounder will resume operation for the timeout duration if the panel has not been disarmed at the end of the 2-way session.

- i** This option must be ON for UL Listed Installations.

- [8] **ON:** Two-Way Audio is Initiated by the CS Operator: The alarm sounds but the 2-way audio session does not begin until the central station operator activates it. The siren turns off once the 2-way audio session has begun.  
**OFF:** Two-Way Audio Session is Immediate: The siren turns off and the 2-way audio session begins immediately after sending the event.

**[601] 2-way Audio Control Options 2 (applies to SCW9057 only)****Option Description**

- [1] **ON:** Talk/Listen on Phone #1 Enabled. If Talk/Listen is required for an event, the panel initiates a Talk/Listen session with the central station on phone #1.  
**OFF:** Talk/Listen on Phone #1 Disabled. The panel does not request a Talk/Listen session on Phone #1.
- [2] **ON:** Talk/Listen on Phone #2 Enabled. If Talk/Listen is required for an event, the panel initiates a Talk/Listen session with the central station on phone #2.  
**OFF:** Talk/Listen on Phone #2 Disabled. The panel does not request a Talk/Listen session on Phone #2.
- i** When using redundant communications with phone line and Cellular, if 2-way audio is enabled, a 2-way voice session is established over both paths at the same time.
- [3] **ON:** Talk/Listen on Phone #3 Enabled. If Talk/Listen is required for an event, the panel initiates a Talk/Listen session with the central station on phone #3.  
**OFF:** Talk/Listen on Phone #3 Disabled. The panel does not request a Talk/Listen session on Phone #3.
- [4] **ON:** Talk/Listen on Phone #4 Enabled. If Talk/Listen is required for an event, the panel initiates a Talk/Listen session with the central station on phone #4.  
**OFF:** Talk/Listen on Phone #4 Disabled. The panel does not request a Talk/Listen session on Phone #4.
- [5]-[8] Future Use

**[609] Module Tamper Reporting Codes**

This section is used for programming keypad and siren tamper reporting codes. A value of 00 can be entered to disable individual reporting codes.

**[610] Alternate Communicator Receiver Trouble Reporting Codes**

This section is used for programming alternate communicator receiver trouble reporting codes. A value of 00 can be entered to disable individual reporting codes.

**[611] Repeater Tamper Reporting Codes**

This section is used for programming WS4920/8920 tamper reporting and AC loss codes. A value of 00 can be entered to disable individual reporting codes.

**[700] Automatic Clock Adjust**

The value entered here adds or subtracts seconds at the end of each day to compensate for inaccuracies in the system time. Valid entries are 00-99, with 60 seconds being the default. Monitor the time lost by the panel over a period of time to determine the average value required for this section.

Example: Panel loses an average of 9 seconds a day. Instead of loading 60 seconds for the last minute of each day, program the panel to load 51 seconds with the use of section [700]. This will speed up the panel by 9 seconds every day, thereby fixing the problem.

**[701] First International Options****Option Description**

- [1] **ON:** 50 Hz AC. Configures the system for 50Hz AC.  
**OFF:** 60 Hz AC. Configures the system for 60Hz AC.
- [2] **ON:** Time Base - Internal Crystal. The system uses the internal crystal for the internal panel clock.  
**OFF:** Time Base - AC Line. The system uses the AC frequency for the internal panel clock.
- [3] **ON:** AC/DC Arming Inhibit Enabled. The system inhibits arming if a Low Battery or AC trouble condition is present.  
**OFF:** AC/DC Arming Inhibit Disabled. Arming is not inhibited.
- [4] **ON:** All System Tamper Require Installer Reset. All Tamper troubles latch and arming is inhibited. Enter Installer Programming to clear the trouble condition and return to normal operation.  
**OFF:** All System Tamper Follow Restore. Tamper troubles do not latch and do not inhibit arming. Manual bypassing of a zone does not bypass the tamper or fault states (DEOL).
- [5] **ON:** 6-digit User Access Codes. All access codes are 6 digits long.  
**OFF:** 4-digit User Access Codes. All access codes are 4 digits long.
- [6] **ON:** Busy Tone Detection Enabled. The system hangs up if a busy tone is detected.  
**OFF:** Busy Tone Detection Disabled. The system does not detect busy tones.
- [7] **ON:** High Capacity Battery Charge. Enable this option when using the 3.6Ah battery (part # 17-152). The battery is charged for 48 hours after power-up. This option is enabled by default for panels shipped with a 3.6Ah battery.  
**OFF:** Standard Capacity Battery Charge. Enable this option when using the 1.5Ah battery (part # 17-145). The battery is charged for 24 hours after power-up. This option is enabled by default for panels shipped with a 1.5Ah battery.
- Note:** For ULC Residential Fire Installations, a 3600 mAh Ni-MH battery pack must be used and this option must be ON in order to provide 24 Hr. battery standby plus 5 minutes alarm annunciation.
- [8] Future Use

## [702] Second International Options

### Option Description

- [1] **ON:** Pulse Dialing Make/Break ratio is 33/67. The communicator uses 33/67 make/break ratio when pulse dialing.  
**OFF:** Pulse Dialing Make/Break ratio is 40/60. The system uses 40/60 make/break ratio.
- [2] **ON:** Force Dialing Enabled. The system dials regardless of the presence of dial tone after the first attempt.  
**OFF:** Force Dialing Disabled. The system dials only if dial tone is detected.
- [3] Future Use
- [4] **ON:** 1600Hz Handshake. 1600Hz handshake used.  
**OFF:** Standard Handshake. Standard handshake is used.
- [5] **ON:** ID Tone Enabled. The system generates a tone every 2 seconds indicating digital equipment is making the call rather than a voice call.  
**OFF:** ID Tone Disabled. The system does not generate a tone.
- [6] **ON:** 2100 Hz. ID Tone. The tone generated (2100Hz.) indicates that digital equipment is making the call.  
**OFF:** 1300 Hz. ID Tone. The tone is 1300Hz.
- [7]-[8] Future Use

## [703] Delay Between Dialing Attempts

Program the time the system waits between dialing attempts to transmit a reporting event to the central station. Valid entries are [001] to [255].

## [800] Door Chime Options for Zones 1-64

Keypads and indoor sirens can annunciate one of four different door chime tones for each zone on the system.

Each section contains the following chime options:

- Enable one door chime option for each zone.
- If more than one option is enabled, the highest numerical option enabled takes precedence.  
For example: If options 3 and 1 are both enabled, then the zone sounds option 3 - "Ding-Dong."
- If all door chime options are disabled, the keypad/siren does not sound a door chime tone for that particular zone.

### Option Description

- [1] **ON:** Standard Door Chime Enabled. Traditional door chime tone found on other DSC keypads (6 quick beeps).  
**OFF:** Standard Door Chime Disabled.
- [2] **ON:** "Bing-Bong" Door Chime Enabled.  
**OFF:** "Bing-Bong" Door Chime Disabled.
- [3] **ON:** "Ding-Dong" Door Chime Enabled.  
**OFF:** "Ding-Dong" Chime Disabled.
- [4] **ON:** 4-second Alarm Tone Door Chime Enabled. The keypad/siren sounds a medium volume alarm signal for 4 seconds.  
**OFF:** 4-second Alarm Tone Door Chime Disabled.

[5]-[8] Future Use

## [804]-[001]-[064] Wireless Device Serial Number

These sections are for manual enrollment of wireless device electronic serial numbers (ESN).

- See [804][101]-[116] for one-way and two-way wireless key enrollment.
- See [804][201]-[204] for two-way keypad enrollment.
- See [804][301]-[304] for two-way siren enrollment.

This is a 6-digit (one-way) or 8-digit (2-way) entry. For toggling entries between decimal and hexadecimal values, press [\*].

### One-way Devices

The first digit of a 6-digit serial number for one-way devices identifies the type of device as indicated below:

- 2 Door/Window Contact, Flood Sensor or Wireless Repeater
- 3 PIR or Glass Break Detector
- 4 Smoke Detector
- 5 Panic Pendant
- 8 Carbon Monoxide Detector

**i** Leading 00s must be entered for one-way wireless devices with six-digit serial numbers (E.g., SN 234567 must be entered as 00234567).

### [804][081] Wireless Supervisory Window

This entry is used to program the length of time a wireless device must be absent from the system before a fault is generated. The wireless supervisory window is calculated by multiplying the programmed value by 15 minutes.

Valid entries are 04 to 96 which correlates to 1 to 24 hours. The default value for North America is 96 (24 hours) and 08 (2 hours) for Europe.

- i** This timer may run the programmed time plus up to the number of minutes programmed in this section. For example, the European default is 2 hours, but the actual time could be as long as 2 hours and 8 minutes. The North American default is 24 hours, but the actual time could be as long as 25 hours and 36 minutes.  
**Note:** UL fire listings require a 4 Hr setting (4 Hrs = 16, 16x15 minutes).

### [804][082]-[089] Zone Transmitter Supervision Options

Program these sections if the zone transmitter will be supervised. All zones are enabled for supervision by default.

- i** DSC does NOT recommend supervision of panic pendants, because they may be removed from the premises.

### [804][101]-[116] Wireless Key Serial Number

These sections are used to enter the wireless key serial numbers. Each 2-way serial number is an 8-digit hexadecimal entry. To toggle entries between decimal and hexadecimal values, press [\*]. One-way serial numbers are 6-digits. "00" must be added to the start of a 6-digit serial number.

### [804][141]-[156] Wireless Key Function Key Options

Up to 6 unique functions can be programmed for each wireless key. Each section requires four 2-digit entries. The following table describes each programmable function.

Entry	Description	DSC Wireless Key
00	Null Key (Not Used)	YES
03	Stay Arm	YES
04	Away Arm	YES
05	[*][9] No-Entry Arm	[*][9] No-Entry Arm can be used if the wireless key being used is identified.
06	[*][4] Chime On / Off	YES
13	Command Output 1 [*][7][1]	[*][7][1] commands can be used with an access code if the wireless keys are identified.
14	Command Output 2 [*][7][2]	[*][7][2] commands can be used with an access code if the wireless keys are identified.
16	[*][0] Quick Exit	YES
17	[*][1] Reactivate Stay/Away Zones	YES
25	Instant Stay Arm	YES
27	Disarm (Off)	Disarming can be used with an access code, as long as the wireless keys are identified.
29	Auxiliary Alarm	YES
30	Panic Alarm	YES
33	Night Arm	YES

### [804][181]-[182] Wireless Key Enable/Disable

These sections enable each individual key enrolled on the system. The keys are all enabled on the system by default.

### [804][201]-[204] Wireless Keypad Serial Number

These sections are used to enter the wireless keypad and IT-410 serial numbers. The number is an 8-digit hexadecimal entry. To toggle between decimal and hexadecimal value entries, press [\*].

### [804][301]-[304] Wireless Siren Serial Number

These sections are used to enter the wireless siren serial numbers. The number is an 8-digit hexadecimal entry. To toggle between decimal and hexadecimal value entries, press [\*].

### [804][311]-[314] Wireless Siren Options for Sirens 1-4

Each section contains the following 8 options:

**Option Description**

- [1] **ON:** Siren Enabled. The WT49X1 activates at full volume for fire, burglary, and CO alarm conditions. This option also enables walk test and system test indications for WT49X1 modules, and placement test, walk test, and system test indications for WT4911 modules.  
**OFF:** Siren Disabled. The WT49X1 does not activate for fire, burglary, CO Alarm, walk test or system test indications. Placement test is still sounded by WT4901 modules.
- [2] **ON:** Buzzer Notifications Enabled. The siren activates audible signals for entry/exit delays, and 24 hour buzzer zone alarms. This may be desirable for indoor sirens, but not outdoor sirens.  
**OFF:** Buzzer Notifications Disabled. Audible signals are not sent.
- [3] **ON:** Door Chime Enabled. The siren activates for door chime conditions.  
**OFF:** Door Chime Disabled. The siren does not activate for door chime conditions.

- [4] **ON:** Trouble Beeps Enabled. The siren activates for trouble beep conditions. Trouble beeps are sounded until any key on the keypad is pressed or until all trouble conditions are restored. This is intended for indoor sirens, but not outdoor sirens or sirens that are mounted in a sleeping area.  
**OFF:** Trouble Beeps Disabled. The siren does not activate for trouble beeps.
- [5] **ON:** Bell Squawks Enabled. The siren activates programmed bell squawk conditions (e.g., arming, disarming, disarming with alarms in memory). This may be desirable for outdoor sirens, but not indoor sirens. These squawks are sounded at full alarm volume.  
**OFF:** Bell Squawks Disabled. The siren does not activate for bell squawk conditions.
- [6] **ON:** Strobe Enabled (WT4911 only). The strobe activates for alarms, placement test, walk test, system test and arm/disarm squawk indications. The strobe can be used to identify a system alarm before entering the premises.  
**OFF:** Strobe Disabled. The strobe does not activate.
- [7] **ON:** Buzzer Alarm / Strobe Follows Bell Time Out. Indoor Siren - If the indoor siren is set for buzzer notifications (option 2), buzzer alarms, such as 24 Hr buzzer zone types are shut off after they have been active for the duration of BTO. Outdoor siren: If the strobe is enabled on the outdoor siren (option 6), the strobe shuts off once the siren is shut off at the end of the bell duration.  
**OFF:** Buzzer Alarms / Strobe Follows Alarm Condition. Indoor siren - The siren sounds the buzzer alarm until the alarm condition has been acknowledged (silenced) at the keypad. Outdoor siren: The strobe continues until an access code has been entered at a system keypad, or a successful disarming request has been serviced.
- [8] **ON:** Siren Tamper Enabled. Tamper conditions from the siren generate a tamper trouble. The panel logs and communicates the event.  
**OFF:** Siren Tamper Disabled. Tamper conditions from the siren do not generate a tamper trouble. The panel logs and communicates the event. If a siren tamper condition is present in [\*][2], turning off this option clears the trouble from the system.
- i** This option must be Off for CP-01 compliance.

### [804][320] Global Siren Options

When these options are enabled or disabled, they affect all wireless devices on the system.

#### Option Description

- [1] **ON:** Tamper Activates Siren / Strobe While Disarmed. When the system is in a disarmed state, a tamper condition from any enrolled siren causes the system sirens and strobes to activate.  
**OFF:** Tamper Does not Activate Siren / Strobe While Disarmed. When the system is in a disarmed state, a tamper condition from any enrolled siren will not cause the system sirens and strobes to activate.
- [2] **ON:** Pre-Alarm Signal Enabled. When the system begins entry delay the entry delay time is sent to the wireless siren. If the wireless siren does not receive a disarm command during the entry delay time, the siren will go into alarm.  
**OFF:** Pre-Alarm Signal Disabled. When the system begins entry delay no entry delay time is sent to the wireless siren. The siren will not go into alarm until it receives a signal from the panel to tell it to go into alarm.
- [3]-[8] Future Use

### [804][330] Maximum Outdoor Siren Activation Timer

This value determines the maximum time the wireless siren sounds before automatically turning off.

### [804][401]-[404] Wireless Repeater Programming

These sections are used to enroll up to four WS4920 repeaters. During quick enroll, select slot 00 to enroll the device as a repeater. The next available section ([401]-[404]) is displayed. Repeaters are placement tested using section [907].

**Note:** For Repeater supervision, ensure that dip switch 3 on the repeater is in the OFF state.

### [804][900] General Wireless Options

When these options are enabled or disabled, they affect all wireless devices on the system.

#### Option Description

- [1] **ON:** Repeater Harsh Placement Test Enabled. When interference is present between the Repeater and the SCW9055/57, this functionality allows the installer to place the Repeater closer to the receiver to establish a stronger communication path. This option does not affect or change the location characteristics of any other devices. This option is automatically disabled when exiting Installer Programming.  
**Note:** Only use this option when interference is detected using the Repeater placement test (Yellow LED on Repeater is ON) or the Receiver Placement Test (section [907] on the SCW9055/57).  
**OFF:** Repeater Harsh Placement Test Disabled.
- [2]-[6] Future Use
- [7] **ON:** RF Jam Disabled. RF Jam conditions are NOT detected, displayed and communicated.  
**OFF:** RF Jam Enabled. RF Jam conditions are detected, displayed and communicated.
- [8] Future Use

**[850] Cellular Signal Strength**

This section displays Cellular network signal strength on the LCD (“Cellular” is displayed on the first line). Scroll to the second line to view. If the SIM card is activated, the second line displays **T** and the signal strength bars. If the SIM card is not activated, **X** is displayed beside the signal bars. Maximum signal strength is 5 bars.

**[851] Alternate Communicator Module Programming**

Refer to the Communicator installation manual for programming details.

**[898] Wireless Device Enrollment - See Section 2 of this manual.**

**[899] Template Programming - See Section 3 of this manual.**

**[900] Panel Version**

The system displays the version of the control panel (for example, [0100] indicates panel version 1.00).

**[904] Wireless Device Placement Test**

See Chapter 2 for details.

**[905] Wireless Keypad Placement Test**

See Chapter 2 for details.

**[906] Wireless Siren Placement Test**

See Chapter 2 for details.

**[907] Wireless Repeater Placement Test**

See Chapter 2 for details.

**[908] Wireless Modules**

This section displays all wireless modules enrolled on the alarm system. View enrolled module names and slot numbers using the scroll keys. e.g., an indoor siren enrolled on slot one is displayed as 'WT49X1 1'.

**[990] Installer Lockout Enable**

Enter Section [990][Installer Code][990] to enable this feature. A hardware default cannot be performed when the Installer Lockout feature is ON. If the panel is powered up, the system chatters the line seizure relay 10 times to indicate the feature is ON.

**[991] Installer Lockout Disable**

Enter Section [991][Installer Code][991] to turn the Installer Lockout feature OFF.

**[992] Alternate Communicator Module Label Broadcast**

This section allows the installer to broadcast the partition and zone labels stored in the panel to the Alternate Communicator module SMS label programming sections. Press [\*] to broadcast the labels or [#] to exit the section. An error tone is sounded if the alternate communicator module is disabled (section [382] option 5) or is not present. Note: Label broadcast must be initiated by the SCW9055/57 main unit.

**[996] Restore Wireless Device Programming Factory Defaults**

Enter Section [996][Installer Code][996] to return wireless programming to factory defaults.

**[998] Restore Panel Default Programming**

Enter Section [998][Installer Code][998] to return control panel programming (including 2-way Audio options) to factory defaults.

- i** Wireless device programming and keypad programming are not defaulted.
- i** To default Labels, see Section [996] Label Reset in Keypad Programming.
- i** To default Wireless Devices, see Section [996] above.

**[999] Restore Factory Default Programming**

Enter Section [999][Installer Code][999] to return system programming to factory defaults.

- i** Except for labels, all programming including wireless device programming and keypad programming is returned to factory defaults. To default labels, see Section [996] Label Reset in Keypad Programming.

**Hardware Reset (Default) Main Control Panel**

Perform the following to default the main control panel:

1. Power down the system completely.
2. Connect a short between I/O 1 and I/O 2 on the control panel (remove all other wires from these terminals).
3. Power up the control panel (AC power only) for 10 full seconds.
4. Power down the control panel, remove short between I/O 1 and I/O 2.
5. Power up the control panel.

**Local Keypad Programming**

To access Keypad Programming, enter [\*][8][Installer's Code][\*].

To return to System Programming, press [\*].

## [000] Keypad Function Key Programming

This section is used to program the keypad function keys. To access enter [\*][000] from Installer Programming. Enter digits 1 to 5 to select a function key (F1-F5) for programming. Key in a 2-digit entry to assign a function to the key. The system returns to the key selection screen (in section [000]). Changes to this programming section affect only the keypad used to program the changes.

### Function Key Options

- . Function keys must be held for 2 seconds to perform the described function.
- 1 Function keys only perform the intended function if the system is not busy. Pressing function keys programmed with option numbers designated “Future Use” causes the keypad to display “Function Not Available” and sound an error tone.
- 00 **Null Key:** (Not Used) The key does not perform any function or give any acknowledgement beeps when pressed.
- 01-02 Future Use
- 03 **Stay Arm:** The system arms with all Stay/Away and Night zones auto-bypassed even if delay zones are violated during the exit delay. This key only works while the system is disarmed, or armed in the Away mode. The panel logs “*Armed in Stay Mode*” for this closing type. If there are no Stay/Away zone types programmed on the system, the system arms in Away mode, and the panel logs “*Armed in Away Mode*.”
- 04 **Away Arm:** The system arms with all Stay/Away and Night zones active even if no delay zones are violated during the exit delay. This key only works while the system is disarmed, armed in the Stay or Night Mode, or during the Exit Delay. The panel logs “*Armed in Away Mode*” for this closing type.
- 05 **No-Entry Arm [\*][9]:** After pressing this key, enter a valid access code. The system arms with No Entry on Delay zones and all Stay/Away and Night zones are auto-bypassed even if delay zones are violated during the exit delay. The exit delay is silent for this arming type. This key can be used in the armed or disarmed state to allow the user to turn Entry Delay on and off. Entry of a valid access code is required after pressing this key to perform the function when the system is disarmed.
- 06 **Chime ON/OFF [\*][4]:** This key enables (3 beeps) and disables (steady tone) the chime. It functions similarly to entering [\*][4]. This key functions when the system is armed or disarmed.
- 07 Future Use
- 08 **Bypass Mode [\*][1]:** Pressing this key puts the keypad into Zone Bypass mode. It is similar to entering [\*][1] while disarmed. If an access code is required for bypassing (Section [015] Option [5]), the user must press the function key to enter bypass mode then enter the access code before entry is permitted. This key only works while the system is disarmed.
- 09-12 Future Use
- 13 **Command Output #1 [\*][7][1]:** Pressing this key is the equivalent of entering [\*][7][1] to activate the associated PGM. An access code may be required before the output is activated, depending on attribute 5 of the output. This key works whether the system is armed or disarmed.
- 14 **Command Output #2 [\*][7][2]:** Pressing this key is the equivalent of entering [\*][7][2] to activate the associated PGM. An access code may be required before the output is activated, depending on attribute 5 of the output. This key works whether the system is armed or disarmed.
- 15 Future Use
- 16 **Quick Exit [\*][0]:** Pressing this key performs the Quick Exit function and is the same as entering [\*][0] while armed. This key only works while the system is armed. The Quick Exit feature must be enabled (section [015] Option [3]).
- 17 **Reactivate Stay/Away Zones [\*][1]:** Pressing this key removes (or re-enables) the automatic bypass on all Stay/Away zones on the system. It is the same as entering [\*][1] while armed. If Night zones are programmed, the system arms in night mode if this key is pressed while stay armed. If no Night zones are programmed, the system arms in Away mode. The panel logs the appropriate arming log to the event buffer. If armed in Night or Away mode, this key switches the system back to Stay mode. Pressing this key does not switch the system from Night to Away. This key only works when the system is armed.
- 18-24 Future Use
- 25 **Instant Stay Arm:** This feature operates similarly to the Stay arming function key except for the following: When this function key is pressed for 2 seconds, no acknowledgement beeps are sounded, there is no exit delay, and the system arms immediately. The panel logs “*Armed in Stay Mode*” for this closing type. If no Stay/Away zone types are programmed on the system, the system arms in Away mode with an audible exit delay (for the duration programmed in section [005]), and the panel logs *Armed in Away Mode*.  
**Note:** This function key should not be used on CP-01 panels.
- 26-32 Future Use
- 33 **Night Arm:** The system arms with Night zones auto-bypassed even if delay zones are violated during the exit delay. This key only works while the system is disarmed or armed in the Stay Mode. The panel logs *Armed in Night Mode* for this closing type. If no Night zone types are programmed on the system, the system arms in Away mode with an audible exit delay (for the duration programmed in section [005]), and the panel logs *Armed in Away Mode*. The function key must be pressed for 2 seconds. No acknowledgement beeps are sounded and the exit delay is silent.

**[001]-[064] Label Programming (Zone 1-64)**

Zone and other labels in these sections can be customized.

Default labels are in English and do not change when an alternate language is selected.

Labels can be programmed locally or downloaded/uploaded using DLS and Connect 24 interactive software.

To program a zone label:

1. Enter the section number of the label to be programmed. e.g., [\*][8][Installer Code][\*][001].
2. Scroll to the desired character's location using the <> Keys.
3. Enter the number of the corresponding character group until the desired character is displayed.  
Example:  
Press the "2" key 3 times to enter the letter "F."  
Press the "2" key 4 times to enter the number "2."
4. Press [\*] to access the "Select Option" menu. Scroll to "Save" then press [\*] to save the label.

Press	To Enter/Display
[<]	Display Left (Previous character position)
[>]	Display Right (Next character position)
[*]	[SELECT]
[#]	[ESCAPE]
[0]	[SPACE]
[1]	[A], [B], [C], [1]
[2]	[D], [E], [F], [2]
[3]	[G], [H], [I], [3]
[4]	[J], [K], [L], [4]
[5]	[M], [N], [O], [5]
[6]	[P], [Q], [R], [6]
[7]	[S], [T], [U], [7]
[8]	[V], [W], [X], [8]
[9]	[Y], [Z], [9], [0]

**WORDS** - This option provides access to the Label Library, a collection of words commonly used when programming labels.

**ASCII ENTRY** - This option is for entering uncommon characters, or as a primary method for programming labels. 255 character entries are available, although some entries are duplicated. Use the [<] [>] keys to scroll through the characters or enter a 3-digit number from 000-255. Press the [\*] key to enter a character in the label.

**CHANGE CASE** - This option toggles the letter entry between upper case letters (A, B, C) and lower case letters (a, b, c).

**CLEAR TO END** - This option clears the display from the character where the cursor is located to the end of the display.

**CLEAR DISPLAY** - This option sets all characters in a label to "space" or cleared.

**SAVE** - Saves the new label. If save is not selected before leaving the label programming section, the changes are lost.

**Label Library**

The Label Library is a database of words commonly used when programming labels. Individual words can be combined as needed. e.g., Front + Door. Each line of the display supports a maximum of 14 characters. If a word will not fit on a line, scroll right until the cursor appears at the first character of the second line then add the word.

To program a custom label using the Label Library:

1. Enter keypad programming and select the label to change. e.g., [\*][8][Installer Code][\*][001] (to program the label for zone 01).
2. Press [\*] to open the "Select Options" menu.
3. Press [\*] again to select the "Words" option.
4. Enter the 3-digit number corresponding to a word (see Words Table below) or use the scroll keys [<][>] to view words in the library.
5. Press [\*] to select the word.
6. To add another word, repeat the above procedure from step 2.
7. To add a space, press the right scroll key [>].
8. To clear characters, select "Clear to End" or "Clear Display" from the "Select Options" menu.
9. To save the current label, press [\*] to access the "Select Options" menu, scroll left [<] to "Save" then press [\*] again.



## Words Table

Item #	Text	Item #	Text	Item #	Text	Item #	Text	Item #	Text	Item #	Text
001	Aborted	042	Control	083	Garage	124	Motion	165	Shop	206	E
002	AC	043	Date	084	Gas	125	No	166	Side	207	F
003	Access	044	Daughter's	085	Glass	126	North	167	Siren	208	G
004	Active	045	Degrees	086	Goodbye	127	Not	168	Sliding	209	H
005	Activity	046	Delay	087	Gym	128	Now	169	Smoke	210	I
006	Alarm	047	Den	088	Hallway	129	Number	170	Son's	211	J
007	All	048	Desk	089	Heat	130	Off	171	Sound	212	K
008	AM	049	Detector	090	Hello	131	Office	172	South	213	L
009	Area	050	Dining	091	Help	132	OK	173	Special	214	M
010	Arm	051	Disarmed	092	High	133	On	174	Stairs	215	N
011	Armed	052	Door	093	Home	134	Open	175	Stay	216	O
012	Arming	053	Down	094	House	135	Opening	176	Sun	217	P
013	Attic	054	Download	095	In	136	Panic	177	Supervisory	218	Q
014	Auxiliary	055	Downstairs	096	Install	137	Partition	178	System	219	R
015	Away	056	Drawer	097	Interior	138	Patio	179	Tamper	220	S
016	Baby	057	Driveway	098	Intrusion	139	Pet	180	Temperature	221	T
017	Back	058	Duct	099	Invalid	140	Phone	181	Test	222	U
018	Bar	059	Duress	100	Is	141	Please	182	Time	223	V
019	Basement	060	East	101	Key	142	PM	183	To	224	W
020	Bathroom	061	Energy Saver	102	Kids	143	Police	184	Touchpad	225	X
021	Battery	062	Enter	103	Kitchen	144	Pool	185	Trouble	226	Y
022	Bedroom	063	Entry	104	Latchkey	145	Porch	186	Unbypass	227	Z
023	Bonus	064	Error	105	Laundry	146	Power	187	Unit	228	(Space)
024	Bottom	065	Exercise	106	Left	147	Press	188	Up	229	' (Apostrophe)
025	Breezeway	066	Exit	107	Level	148	Program	189	West	230	- (Dash)
026	Building	067	Exterior	108	Library	149	Progress	190	Window	231	_ (Underscore)
027	Bus	068	Factory	109	Light	150	Quiet	191	Zone	232	*
028	Bypass	069	Failure	110	Lights	151	Rear	192	0	233	#
029	Bypassed	070	Family	111	Living	152	Receiver	193	1	234	:
030	Cabinet	071	Father's	112	Load	153	Report	194	2	235	/
031	Cancelled	072	Feature	113	Loading	154	RF	195	3	236	?
032	Car	073	Fence	114	Low	155	Right	196	4		
033	Carbon	074	Fire	115	Lower	156	Room	197	5		
034	Central	075	First	116	Main	157	Safe	198	6		
035	Chime	076	Floor	117	Master	158	Schedule	199	7		
036	Closed	077	Force	118	Mat	159	Screen	200	8		
037	Closet	078	Foyer	119	Medical	160	Second	201	9		
038	Closing	079	Freeze	120	Memory	161	Sensor	202	A		
039	Code	080	Front	121	Menu	162	Service	203	B		
040	Communicator	081	Furnace	122	Monoxide	163	Shed	204	C		
041	Computer	082	Gallery	123	Mother's	164	Shock	205	D		

**[065] Fire Alarm Label**

Enter a 28-character Fire Alarm label. Default value = "FIRE-ZONE"

**[066] Fail to Arm Event Message**

Enter a 32-character Fail to Arm Event Message. Default value = "SYSTEM HAS -----", "FAILED-TO-ARM---

**[067] Alarm When Armed Event Message**

Enter a 32-character Alarm when Armed Event Message. Default value = “ALARM-OCCURRED--”, “WHILE-ARMED---”

**[074] First Keypad Options****Option Description**

- [1] **ON:** [F] Key Enabled. Pressing and holding the Fire key for 2 seconds sends a fire key alarm request to the panel. The keypad displays “Hold Keys Down for Fire Alarm.”  
**OFF:** [F] Key Disabled. Pressing the Fire key does not send an alarm or change the keypad's display.
- [2] **ON:** [A] Key Enabled. When the [A] key is pressed and held, the keypad generates an [A]ux key alarm. The display prompts the user to hold the key.  
**OFF:** [A] Key Disabled. Prevents the keypad from requesting an [A]ux key alarm.
- [3] **ON:** [P] Key Enabled. When the [P] key is pressed and held, the keypad generates a [P]anic key alarm. The display prompts the user to hold the key, depending on the setting of Option 8 (in this section).  
**OFF:** [P] Key Disabled. Prevents the keypad from requesting a [P]anic key alarm.
- [4] **ON:** Quick Arm Prompt ON. When in the Disarmed Star menu, the *Quick Arm* prompt is displayed.  
**OFF:** Quick Arm Prompt OFF. The *Quick Arm* prompt is disabled.
- [5] **ON:** Quick Exit Prompt ON. When in the Armed Star menu, the *Quick Exit* prompt is displayed.  
**OFF:** Quick Exit Prompt OFF. The *Quick Exit* prompt is disabled.
- [6] **ON:** Bypass Options Prompt ON. In the [\*1] Bypass menu, the *Bypass Options* prompt is displayed. This is a local function prompt. When selected, the keypad displays the Bypass Options menu.  
**OFF:** Bypass Options Prompt and menu OFF. Prompt and menu is disabled.
- [7] **ON:** User Initiated Call-Up Prompt ON. In the [\*6] User Functions menu, the User Initiated Call-up prompt is Displayed. When this prompt is selected, the keypad sends a [6] key.  
**OFF:** User Initiated Call-Up Prompt OFF. The prompt is not displayed.
- [8] **ON:** Hold [P]anic Key Prompt ON. When holding the [P] key, the display prompts the user to hold the [P] key to generate a Panic alarm. This is a local prompt.  
**OFF:** Hold [P] Key Prompt OFF. When holding the [P] key, the user receives no feedback that the key has been pressed. The display and backlighting does not change.

**[075] Second Keypad Options****Option Description**

- [1] **ON:** Local Clock Display Enabled: When the keypad is not being used, the keypad returns to displaying the Time and Date until another key is pressed.  
**OFF:** Local Clock Display Disabled. Time and date is not displayed on the keypad.
- [2] **ON:** Local Clock Displays 24 Hour Time. When this feature is enabled, the time is displayed in 24 hour military format.  
**OFF:** Local Clock Displays AM/PM Time. When this feature is enabled, the time is displayed in 12 hour format (AM/PM). This option does not affect the time programming menu, which is always in 24-hour time format.
- [3] **ON:** Auto Alarm Scroll Enabled. When the bell is active or when there is an alarm in memory while armed, the keypad scrolls automatically and displays all alarms.  
**OFF:** Auto Alarm Scroll Disabled. The keypad does not scroll automatically and display all alarms.
- [4] **ON:** Language Selection Accessible from Any Menu. Pressing and holding [<][>] for 2 seconds displays the language selection menu.  
**OFF:** Language Selection Accessible from Installer Menu Only. Pressing and holding [<][>] for 2 seconds generates an error tone.
- [5] **ON:** Power LED Enabled. The LED functionality is defined by Option 6.  
**OFF:** Power LED Disabled. Option 6 has no effect.
- [6] **ON:** Power LED Indicates AC Present. The LED is ON to indicate AC power is present. If AC is absent, the LED is OFF.  
**OFF:** Power LED Indicates AC Absent. The LED is ON to indicate AC power is absent. If AC is present, the LED is OFF.
- [7] **ON:** Alarms are Displayed while Armed. If any alarms occur while armed, the keypad displays the alarms by identifying the zones.  
**OFF:** Alarms are Not Displayed while Armed. If any alarms occur while armed, the keypad does not show any indication that an alarm occurred on the system. When the system is disarmed, the keypad still enters Alarm Memory to indicate which zones went into alarm during the alarm period.
- [8] **ON:** Auto Scroll Open Zones Enabled. When a zone is open, the keypad scrolls automatically and display all open zones. Open zones also override the local clock display.  
**OFF:** Auto Scroll Open Zones Disabled. Open zones are not displayed.

**[076] Third Keypad Options****Option Description**

[1]-[4] Future Use

[5] **ON:** Late to Open Prompts Enabled. The “*Late to Open*” enable/disable prompts in [\*][6] user functions are available in the menu.**OFF:** Late to Open Prompts Disabled. The “*Late to Open*” enable/disable prompts are not available.

[6]-[8] Future Use

**[077] Programmed LCD Message**

Enter a 32-character message. If any characters other than blanks are programmed into this section, the keypad times out to this message instead of the Time and Date display. Any option or feature that overrides the clock display also override the LCD message. An override by the system is not counted against the Message Duration programmed in Section [078]. This message can be programmed in Installer Programming or using DLS.

**[078] Programmed LCD Message Duration**

This section is used to program the number of times an LCD message must be cleared from the LCD displays (by pressing any key) before it is no longer displayed. When programmed on the system, the LCD keypad displays the message when not in use. Programming 000 in this section results in the message never clearing. This could be used as a greeting (residential) or a company message (commercial). This overrides the settings of Clock Display options in Section [075].

Valid Entries are 001 to 255 seconds. 000 = Unlimited Duration.

**[100] CO Detector Alarm Label**

Use this section to program a custom label for the CO Detector zone. This label is displayed on the keypad during CO detector zone alarms. The CO Detector Alarm label can be 14x2 characters in length. Default message is CO\_Alarm\_Evacuate\_Area.

**[101] System Label**

Use this section to program a custom label for the system. This label is used on various displays to refer to the alarm system. The default label is “System.” The system label can be up to 14x2 characters in length.

**[120]-[121] Command Output Labels**

Use these sections to program custom command output labels. These labels are used by the system to display output use and output activation events in the event buffer. Command output labels can be 14x2 characters in length.

**[996] Label Default**

This section resets programmable labels to factory defaults. Entering this section and pressing [\*] returns all programmable system labels to default conditions in the currently active language. Keypad configuration sections are not affected.

**[997] Keypad Version**

Entering this section displays the keypad version. The keypad version is displayed as a 4-digit decimal entry.

E.g., Entry is 1234 = Version 12.34. This is a read-only value.

**[998] Initiate Global Label Broadcast**

Programmed keypad labels are broadcast and installed on all system keypads from keypad 1.

Enter [\*][998] to broadcast the labels programmed in sections [\*][001]-[069] and [\*][100]-[125]. This function is also required for broadcasting labels downloaded using DLS software.

**i** Initiate this function from the SCW9055/57 main unit. Program all labels manually on the SCW9055/57 first and then broadcasted to WT5500 keypad.

**[999] Reset All Keypad Programming to Factory Defaults**

Resets all keypad programming to the factory defaults. This un-enrolls the keypad from the system.

## 6 Testing & Troubleshooting

### Testing:

- Power up system
- Program options as required (see *programming section*)
- Violate, then restore zones
- Verify correct *Reporting Codes* are sent to the central station

### Troubleshooting:

- Power up system
- Enter [\*][2] to view *Troubles*
- Perform actions indicated in the tables below

### Trouble Summary:

- Trouble [1] Service Required - Press [1] or \* for more information:  
 Low Battery  
 General System Trouble  
 General System Tamper
- Trouble [2] - AC Trouble
- Trouble [3] - Telephone Line Trouble
- Trouble [4] - Failure to Communicate
- Trouble [5] - Zone Fault -Press [5] or \* for more information
- Trouble [6] - Zone Tamper - Press [6] or \* for more information
- Trouble [7] - Wireless Device Low Battery - Press [7] or \* for more information
- Trouble [8] - Loss of Time or Date - Press \* to program date and time

Trouble	Cause	Troubleshooting
<b>Trouble [0] Alternate Communicator Trouble</b>		<b>Press [&lt;][&gt;] to determine specific trouble</b>
Alternate Comm SIM Lock	The SIM lock feature has been enabled and the unit has not been programmed with the correct PIN for the SIM card.	• Refer to the Communicator installation manual for more details.
Alternate Comm Cellular Trouble	This condition is created when the alternate communicator has detected a radio or SIM failure, a cellular network trouble, or insufficient signal strength.	• Refer to the Communicator installation manual for more details.
Alternate Comm Ethernet Trouble	This condition is created when the alternate communicator has detected a network absent condition.	• Refer to the Communicator installation manual for more details.
Alternate Comm Receiver Trouble	This condition is generated when the alternate communicator loses supervision or fails to initialize a receiver.	• Refer to the Communicator installation manual for more details.
Alternate Comm Supervision	This condition is created when the panel loses communication with an Ethernet or cellular receiver on the system.	• Refer to the Communicator installation manual for more details.
Alternate Comm Config SMS Trouble	This condition is created when the alternate communicator detects an SMS Connect 24 Configuration SMS failure trouble.	• Refer to the Communicator installation manual for more details.
Alternate Comm Fault	This condition is created by the SCW9055/57 when the alternate communicator has not responded to any poll commands. Alternate Comm Fault is displayed in [*][2] and the event buffer. The reporting code for this trouble is General System Supervisory.	• Refer to the Communicator installation manual for more details.

**Trouble [1] Service Required****Press [1] to determine specific trouble**

Low Battery	The panel detects that no battery is present, that the battery is shorted, or that the battery is below the low battery threshold (less than 7.2VDC). <b>NOTE:</b> This trouble condition will clear once the panel determines that the low battery restore threshold (7.6 VDC) has been reached.	NOTE: If battery is new, allow 24 Hrs. to charge. <ul style="list-style-type: none"> <li>• Verify voltage measured across AC terminals is 16-18 VAC.</li> <li>• Verify voltage measured across battery terminals is 12.5V +/- 0.1V.</li> <li>• Replace transformer if required.</li> <li>• Disconnect then reconnect battery leads.</li> <li>• If Low Battery Trouble LED is still on after 10 minutes, replace battery.</li> </ul>
General System Trouble	Communications with the wireless receiver have failed causing a Hardware fault, an Aux Supply Trouble is present or the LCD display is not functioning.	<ul style="list-style-type: none"> <li>• Check event buffer to determine specific trouble.</li> <li>• If buffer logs "Hardware Fault" or "LCD Loss" replace panel.</li> <li>• If necessary, test AC outlet for loss of power and remedy.</li> </ul>
General System Tamper	Cover tamper tripped.	<ul style="list-style-type: none"> <li>• Verify that tamper button is installed into backplate.</li> <li>• Verify that keypad (cover) is secured to backplate.</li> </ul>
RF Jam	The system has detected the presence of an RF jam for 20 seconds or communications with the wireless receiver have failed causing a Hardware fault. An RF jam may also be detected by a wireless repeater. The Trouble light on the alarm panel glows orange to indicate RF jam.	<ul style="list-style-type: none"> <li>• Check Event buffer to determine specific trouble.</li> <li>• If Buffer logs RF Jam trouble, check for external 433MHZ signal sources. To disable RF Jam: enable Option [7] in program section [804] subsection [90].</li> <li>• If Buffer logs Hardware fault - replace panel.</li> </ul>

**Trouble [2] AC Failure**

AC Failure	No AC at panel AC input terminals, enrolled WS4920/8920 repeater has experienced loss of AC power.	<ul style="list-style-type: none"> <li>• Verify voltage measured across AC terminals is 16-18VAC. Replace transformer if required.</li> <li>• If buffer logs "Repeater AC Loss", inspect repeater for cause (power supply unplugged from AC outlet, power supply wires loose or disconnected).</li> </ul>
------------	--	---

**Trouble [3] Telephone Line Trouble**

Telephone Line Trouble	Phone line voltage at TIP, RING on main panel is less than 3VDC.	<p>Measure the voltage across TIP and RING on the panel:</p> <ul style="list-style-type: none"> <li>• No phone off-hook – 50VDC (approx.).</li> <li>• Any phone off-hook – 5VDC (approx.).</li> </ul> <p>Wire incoming line directly to TIP and RING.</p> <ul style="list-style-type: none"> <li>• If trouble clears, check wiring or the RJ-31x phone jack.</li> </ul>
------------------------	--	---

**Trouble [4] Failure to Communicate**

Failure to Communicate	Panel fails to communicate one or more events to central station.	<p>Connect a headset to TIP and RING of the control panel. Monitor for the following conditions:</p> <p><b>Continuous dial tone</b></p> <ul style="list-style-type: none"> <li>• Reverse TIP and RING.</li> </ul> <p><b>Recorded operator message comes on</b></p> <ul style="list-style-type: none"> <li>• Verify correct phone number is programmed.</li> <li>• Dial the number programmed using a regular telephone to determine if a [9] must be dialed or if 800 service is blocked.</li> </ul> <p><b>Panel does not respond to handshakes</b></p> <ul style="list-style-type: none"> <li>• Verify the format programmed is supported by the central station.</li> </ul> <p><b>Panel transmits data multiple times without receiving a handshake</b></p> <ul style="list-style-type: none"> <li>• Verify that the account number and reporting codes are correctly programmed.</li> </ul> <p><b>Contact ID and Pulse formats</b></p> <ul style="list-style-type: none"> <li>• Program a HEX [A] to transmit a digit [0].</li> </ul> <p><b>SIA format</b></p> <ul style="list-style-type: none"> <li>• Program a digit [0] to transmit a digit [0].</li> </ul> <p><b>Alternate Communicator</b></p> <ul style="list-style-type: none"> <li>• Refer to the Communicator installation manual for troubleshooting actions.</li> </ul>
------------------------	---	--

<b>Trouble [5] Zone Fault Press [5] to determine specific zones with a Fault trouble</b>		
1 <sup>st</sup> press - Zone faults 2 <sup>nd</sup> press - Keypad faults 3 <sup>rd</sup> press - Siren faults 4 <sup>th</sup> press - Repeater fault	Hard-wired zone fault condition present. A short circuit is present on one or more zones with double end-of-line resistors enabled.	<ul style="list-style-type: none"> <li>Remove the wire leads from I/O and COM terminals and measure the resistance of the wire leads.</li> <li>Connect a 5.6K resistor (Green, Blue, Red) across the I/O and COM terminals. Verify the trouble condition clears.</li> </ul>
	One or more wireless devices have not checked in within the programmed time.	<ul style="list-style-type: none"> <li>Perform a Module Placement Test – program section [904] and verify the wireless device is in a good location.                             <ul style="list-style-type: none"> <li>If bad test results occur, test the wireless device in another location. If the wireless device now tests good, the original mounting location is bad.</li> <li>If the wireless device continues to give bad test results, replace the wireless device.</li> </ul> </li> </ul>

<b>Trouble [6] Zone Tamper Press [6] to determine specific zones with a Tamper trouble</b>		
1 <sup>st</sup> Press - Zone faults 2 <sup>nd</sup> press - Keypad faults 3 <sup>rd</sup> press - Siren faults 4 <sup>th</sup> press - Repeater fault	An open circuit is present on one or more zones with double end-of-line resistors enabled.	<ul style="list-style-type: none"> <li>Remove the wire leads from I/O and COM terminals and measure the resistance of the wire leads.</li> <li>Connect a 5.6K resistor (Green, Blue, Red) across the I/O and COM terminals.</li> <li>Verify the trouble condition clears.</li> </ul>
	A tamper condition is present on one or more wireless devices.	<ul style="list-style-type: none"> <li>Ensure device cover is secure.</li> <li>Ensure device is correctly mounted for wall tamper operation.</li> <li>Violate, then restore the tamper. If tamper condition persists, replace wireless device.</li> </ul>

<b>Trouble [7] Wireless Device Low Battery Press [7] to scroll through specific devices with a Low Battery Trouble</b>		
1 <sup>st</sup> press - Wireless Zones 2 <sup>nd</sup> press - Wireless Keys 3 <sup>rd</sup> press - Wireless Keypads 4 <sup>th</sup> press - Wireless Sirens 5 <sup>th</sup> press - Wireless Proximity Tags 6 <sup>th</sup> press - Repeater	One or more wireless devices has a low battery.  NOTE: The event is not logged to the event buffer until the wireless device low battery delay time expires.  Program section [377] Opt 9.	<p>Replace Battery</p> <ul style="list-style-type: none"> <li>Verify zone operation.</li> <li>Verify that tamper and low battery condition is cleared and reported.</li> <li>Flashing Trouble LED on keypad indicates low battery. To determine which indoor siren is in low battery, press the Test button. If no test indications are sounded, replace batteries.</li> <li>To determine which outdoor siren is in low battery, remove and reconnect battery. If strobe does not flash, replace battery.</li> <li>If a proximity tag is in low battery, the tag must be deleted and replaced before the trouble is cleared from [*][2].</li> </ul> <p><b>NOTE:</b> Replacing batteries causes a tamper. Replacing cover restores the tamper and sends the associated reporting codes to the central station.</p>

<b>Trouble [8] Loss of Clock/Date</b>		
Loss of time and date	The main panel internal clock is not set.	<p>To program the time and date:</p> <ul style="list-style-type: none"> <li>Enter [*][6][Master Code] then Press [1].</li> <li>Enter the time and date (in military) using the following format: HH:MM MM/DD/YY</li> </ul> <p>Example.</p> <p>For 6:00 pm, Nov. 30, 2007</p> <p>Enter: [18] [00] [11] [30] [07]</p>

## Appendix A: Reporting Code Formats

The following tables contain Contact ID and Automatic SIA format reporting codes. See Programming Sections [320]-[348] for Reporting Codes.

### Contact ID

The first digit (in parentheses) is automatically sent by the control. The second two digits are programmed to indicate specific information about the signal. For example, if zone 1 is an entry/exit point, you could program the event code as [34]. The central station would receive the following:

\*BURG - ENTRY/EXIT - 1 where the "1" indicates which zone went into alarm.

### SIA Format - Level 2 (Hard Coded)

The SIA communication format used in this product follows the level 2 specifications of the SIA Digital Communication Standard - October 1997. This format will send the Account Code along with its data transmission. The transmission will look similar to the following at the receiver:

```
N ri1 BA 01
N = New Event
ri1 = Partition /Area Identifier
BA = Burglary Alarm
01 = Zone 1
```

A system event will use the Area Identifier ri00. Contact ID Zone Alarm/Restore Event Codes

Section #	Reporting Code	Code Sent When...	Dialer Direction*	Automatic Contact ID Codes	SIA Auto Rep Codes**
[320]-[323]	Zone Alarms	Zone goes into alarm	A/R		
[324]-[327]	Zone Restores	Alarm condition has been restored	A/R	See the tables on page 76 for details	
[328]	Duress Alarm	Duress code entered at keypad	A/R	E(1)21-000	HA-00
[328]	Opening After Alarm	System disarmed with alarm in memory	A/R	E(4)58-000	OR-00
[328]	Recent Closing	Alarm occurs within two minutes of system arming	A/R	E(4)59-UUU	CR-UU
[328]	Cross Zone (Police Code) Alarm	Two zones on the same partition go into alarm during any given armed-to-armed period (incl. 24Hr zones)	A/R	E(1)39-000	BM-00/BV-00
[328]	Burglary Not Verified	This event is transmitted when a second cross zone alarm does not occur within the cross zoning time	A/R	E(3)78-000	OC-00
[328]	Alarm Cancelled	Sent when the system is disarmed after an alarm, but before the expiry of the alarm cancellation timer	A/R	E(4)A6-UUU	OC-UU
[329]	[F] Key Alarm/Rest.	Keypad fire alarm (alarm and restore rep. codes sent together)	A/R	E(1)1A-000 R(1)1A-000	FA-00/FH-00
[329]	[A] Key Alarm/Rest.	Keypad auxiliary alarm (alarm and restore rep. codes sent together)	A/R	E(1)AA-000 R(1)AA-000	MA-00/MH-00
[329]	[P] Key Alarm/Rest.	Keypad panic alarm (alarm and restore rep. codes sent together)	A/R	E(1)2A-000 R(1)2A-000	PA-00/PH-00
[329]	Fail to Report In	A zone was not tripped between the inactivity monitoring windows	A/R	E(1)A2-000	NA-00
[330]-[337]	Zone Tamper/Restore	Zone is tampered / tamper condition restored	T/R	E(3)83-ZZZ R(3)83-ZZZ	TA-ZZ/TR-ZZ
[338]	General System Tamper/Rest. (while armed)	Case/cover has a tamper alarm. Case/cover tamper restored while armed	T/R	E(1)37-000 R(1)37-000	ES-00/EJ-00
	General System Tamper/Rest. (while disarmed)	Case/cover has a tamper alarm. Case/cover tamper restored while disarmed	T/R	E(3)17-000 R(3)17-000	ES-00/EJ-00
[338]	Keypad Lockout	Maximum number of incorrect access codes has been entered at a keypad	T/R	E(4)61-000	JA-00
[339-341]	Closings	System armed (user 01-16, 40 indicated)	O/C	E(4)A1-UUU	CL-UU
[341]	Automatic Zone Bypass	A zone was bypassed at the time of arming	O/C	E(5)7A-ZZZ	UB-ZZ
[341]	Partial Closing	One or more zones bypassed when system armed	O/C	E(4)56-000	CG-00
[341]	Special Closing	Closing (arming) using one of the following methods: quick arm, keyswitch, function key, maintenance code, DLS software, wireless key	O/C	E(4)AA-000	CL-00
[341]	Exit Fault	Sent when an exit error occurs and the Entry Delay expires before the system is disarmed	O/C	E(3)74-ZZZ	EA-ZZ
[342-344]	Openings	System disarmed (user 01-16, 40 indicated)	O/C	E(4)A1-UUU	OP-UU
[344]	Special Opening	Opening (disarming) using one of the following: keyswitch, maintenance code, DLS software, wireless key	O/C	E(4)AA-000	OP-00
[344]	Late to Open	The system was not disarmed when the late to open time expired	O/C	E(4)53-000	CT-00
[345]-[346]	Battery Trouble/Rest.	SCW System battery is low/battery restored.	MA/R	E(3)A2-000 R(3)A2-000	YT-00/YR-00
[345]-[346]	AC Line Trouble/Rest.	AC power to control panel is disconnected /AC power restored (Both codes follow AC Failure Comm. Delay.)	MA/R	E(3)A1-000 R(3)A1-000	AT-00/AR-00

Section #	Reporting Code	Code Sent When...	Dialer Direction*	Automatic Contact ID Codes	SIA Auto Rep Codes**
[345]-[346]	Fire Trouble/Rest.	Trouble occurs/restore on a fire zone	MA/R	E(3)73-000 R(3)73-000	FT-00/FH-00
[345]-[346]	Auxiliary Power Trouble/Rest.	Aux voltage supply trouble/restore	MA/R	E(3) 12-000 R(3) 12-000	YP-00/YQ-00
[346]	TLM Fail/Restore	Telephone line restored	MA/R	E(3) 51-000 R(3) 51-000	LT-01/LR-01
[345]-[346]	Gen. System Trouble/Rest.	Hardware fault, LCD Loss, Repeater AC Loss or RF Jam trouble has occurred/ been restored.	MA/R	E(3) AA-000 R(3) AA-000	YX-00/YZ-00
[345]-[346]	Gen. System Supervisory Trouble/Rest.	Control panel has detected an alternate communicator fault/communications restored.	MA/R	E(3) 3A-000 R(3) 3A-000	ET-00/ER/00
[346]	Cold Start	The SCW9055/57 has restarted after total power loss.	MA/R	E(3) A5-000	RR-00
[347]	Phone# 1 to 4 FTC Restore	Control panel has restored communications to central station on Phone# 1 to 4 (after FTC)	MA/R	E(3) 54-000	YK-00
[347]	DLS Lead In	Downloading session start	MA/R	E(4) 11	RB-00
[347]	DLS Lead Out	Downloading session complete	MA/R	E(4) 12	RS-00
[347]	Zone Fault/Rest.	One or more zones have faults/restored	MA/R	E(3) 8A-ZZZ R(3) 8A-ZZZ	UT-ZZ/UJ-ZZ
[347]	Delinquency	Programmed duration (days or hours) for delinquency has expired without zone activity or the system being armed	MA/R	E(6) 54-000***	CD-00
[347]	Wireless Zone Low Battery Trouble/Rest.	Wireless zones have low battery trouble/has been restored	MA/R	E(3) 84-ZZZ R(3) 84-ZZZ	XT-ZZ/XR-ZZ
[347]	Wireless Device Low Battery Trouble/Rest.	Wireless panic pendants and wireless keys have low battery/all low batteries restored	MA/R	E(3) 84-000 R(3) 84-000	XT-00/XR-00****
[347]	Keypad 1 Low Battery/Rest.	Keypad 1 has a low battery trouble/has been restored	MA/R	E(3) 84-070 R(3) 84-070	XT-70/XR-70
[347]	Keypad 2 Low Battery/Rest.	Keypad 2 has a low battery trouble/has been restored	MA/R	E(3) 84-071 R(3) 84-071	XT-71/XR-71
[347]	Keypad 3 Low Battery/Rest.	Keypad 3 has a low battery trouble/has been restored	MA/R	E(3) 84-072 R(3) 84-072	XT-72/XR-72
[347]	Keypad 4 Low Battery/Rest.	Keypad 4 has a low battery trouble/has been restored	MA/R	E(3) 84-073 R(3) 84-073	XT-73/XR-73
[347]	Siren 1 Low Battery/Rest.	Siren 1 has a low battery trouble/has been restored	MA/R	E(3) 84-080 R(3) 84-080	XT-80/XR-80
[347]	Siren 2 Low Battery/Rest.	Siren 2 has a low battery trouble/has been restored	MA/R	E(3) 84-081 R(3) 84-081	XT-81/XR-81
[347]	Siren 3 Low Battery/Rest.	Siren 3 has a low battery trouble/has been restored	MA/R	E(3) 84-082 R(3) 84-082	XT-82/XR-82
[347]	Siren 4 Low Battery/Rest.	Siren 4 has a low battery trouble/has been restored	MA/R	E(3) 84-083 R(3) 84-083	XT-83/XR-83
[347]	Repeater 1 Low Battery/Rest.	Repeater 1 has a low battery trouble/has been restored	MA/R	E(3) 84-090 R(3) 84-090	XT-90/XR-90
[347]	Repeater 2 Low Battery/Rest.	Repeater 2 has a low battery trouble/has been restored	MA/R	E(3) 84-091 R(3) 84-091	XT-91/XR-91
[347]	Repeater 3 Low Battery/Rest.	Repeater 3 has a low battery trouble/has been restored	MA/R	E(3)84-092 R(3)84-092	XT-92/XR-92
[347]	Repeater 4 Low Battery/Rest.	Repeater 4 has a low battery trouble/has been restored	MA/R	E(3)84-093 R(3)84-093	XT-93/XR-93
[347]	Installer Lead In	Installer Programming has been entered	MA/R	E(6)27-000	LB-00
[347]	Installer Lead out	Installer Programming has been exited	MA/R	E(6)28-000	LS-00
[347]	Keypad 1 Fault/Rest.	A wireless supervision fault has occurred/been restored for Keypad 1	MA/R	E(3)8A-070 R(3)8A-070	UT-70/UJ-70
[347]	Keypad 2 Fault/Rest.	A wireless supervision fault has occurred/been restored for Keypad 2	MA/R	E(3)8A-071 R(3)8A-071	UT-71/UJ-71
[347]	Keypad 3 Fault/Rest.	A wireless supervision fault has occurred/been restored for Keypad 3	MA/R	E(3)8A-072 R(3)8A-072	UT-72/UJ-72
[347]	Keypad 4 Fault/Rest.	A wireless supervision fault has occurred/been restored for Keypad 4	MA/R	E(3)8A-073 R(3)8A-073	UT-73/UJ-73
[347]	Siren 1 Fault/Rest.	A wireless supervision fault has occurred/been restored for siren 1	MA/R	E(3) 8A-080 R(3) 8A-080	UT-80/UJ-80
[347]	Siren 2 Fault/Rest.	A wireless supervision fault has occurred/been restored for siren 2	MA/R	E(3) 8A-081 R(3) 8A-081	UT-81/UJ-81
[347]	Siren 3 Fault/Rest.	A wireless supervision fault has occurred/been restored for siren 3	MA/R	E(3) 8A-082 R(3) 8A-082	UT-82/UJ-82
[347]	Siren 4 Fault/Rest.	A wireless supervision fault has occurred/been restored for siren 4	MA/R	E(3) 8A-083 R(3) 8A-083	UT-83/UJ-83
[347]	Repeater 1 Fault/Rest.	A wireless supervision fault has occurred/been restored for Repeater 1	MA/R	E(3) 8A-090 R(3) 8A-090	UT-90/UR-90



Section #	Reporting Code	Code Sent When...	Dialer Direction*	Automatic Contact ID Codes	SIA Auto Rep Codes**
[347]	Repeater 2 Fault/Rest.	A wireless supervision fault has occurred/been restored for Repeater 2	MA/R	E(3) 8A-091 R(3) 8A-091	UT-91/UR-91
[347]	Repeater 3 Fault/Rest.	A wireless supervision fault has occurred/been restored for Repeater 3	MA/R	E(3) 8A-092 R(3) 8A-092	UT-92/UR-92
[347]	Repeater 4 Fault/Rest.	A wireless supervision fault has occurred/been restored for Repeater 4	MA/R	E(3) 8A-093 R(3) 8A-093	UT-93/UR-93
[347]	Panel Firmware Update Begin/ Successful	A local firmware update has begun/ was completed successfully	MA/R	E(9)03-003/ R(9)03-003	LB-00/LS-00
[348]	Walk Test Begin/End	Beginning of test/End of test	T	E(6)A7-UUU R(6)A7-UUU	TS-UU/TEUU
[348]	Periodic Test	Periodic system test transmission	T	E(6)A2-000	RP-00
[348]	System Test	[*][6] bell/communications test	T	E(6)A1-000	RX-00
[609]	Keypad 1 Tamper/Rest.	A tamper condition has been detected/restored from Keypad 1	T/R	E(3)83-070 R(3)83-070	TA-70/TR-70
[609]	Keypad 2 Tamper/Rest.	A tamper condition has been detected/restored from Keypad 2	T/R	E(3)83-071 R(3)83-071	TA-71/TR-71
[609]	Keypad 3 Tamper/Rest.	A tamper condition has been detected/restored from Keypad 3	T/R	E(3)83-072 R(3)83-072	TA-72/TR-72
[609]	Keypad 4 Tamper/Rest.	A tamper condition has been detected/restored from Keypad 4	T/R	E(3)83-073 R(3)83-073	TA-73/TR-73
[609]	Siren 1 Tamper/Rest.	Tamper condition detected/restored for siren 1	T/R	E(3)83-080 R(3)83-080	TA-80/TR-80
[609]	Siren 2 Tamper/Rest.	Tamper condition detected/restored for siren 2	T/R	E(3) 83-081 R(3) 83-081	TA-81/TR-81
[609]	Siren 3 Tamper/Rest.	Tamper condition detected/restored for siren 3	T/R	E(3) 83-082 R(3) 83-082	TA-82/TR-82
[609]	Siren 4 Tamper/Rest.	Tamper condition detected/restored for siren 4	T/R	E(3) 83-083 R(3) 83-083	TA-83/TR-83
[610]	Alternate Communicator Receiver 1 Trouble/Restore	The Atl. Comm. has detected receiver 1 has gone absent or failed to initialize/is present and has been initialized	MA/R	E(3)5A-001 R(3)5A-001	YS-01/YZ-01
[610]	Alternate Communicator Receiver 2 Trouble/Restore	The Atl. Comm. has detected receiver 2 has gone absent or failed to initialize/is present and has been initialized	MA/R	E(3)5A-002 R(3)5A-002	YS-02/YK-02
[610]	General Alternate Communicator Trouble/Restore	The Atl. Comm. has detected/restored a Radio/SIM failure, Cellular Trouble, Ethernet Trouble, or SMS Config Trouble	MA/R	E(3)53-955 R(3)53-955	YX-01/YR-01
[611]	Repeater 1 Tamper/Rest.	Tamper condition detected/restored for Repeater 1	T/R	E(3)83-090 R(3)83-090	TA-90/TR-90
[611]	Repeater 2 Tamper/Rest.	Tamper condition detected/restored for Repeater 2	T/R	E(3)83-091 R(3)83-091	TA-91/TR-91
[611]	Repeater 3 Tamper/Rest.	Tamper condition detected/restored for Repeater 3	T/R	E(3)83-092 R(3)83-092	TA-92/TR-92
[611]	Repeater 4 Tamper/Rest.	Tamper condition detected/restored for Repeater 4	T/R	E(3)83-093 R(3)83-093	TA-93/TR-93
[611]	Repeater 1 AC trouble/Rest.	AC power loss detected/restored for Repeater 1	T/R	E(3)A1-090 R(3)A1-090	AT-90/AR-90
[611]	Repeater 2 AC trouble/Rest.	AC power loss detected/restored for Repeater 2	T/R	E(3)A1-091 R(3)A1-091	AT-91/AR-91
[611]	Repeater 3 AC trouble/Rest.	AC power loss detected/restored for Repeater 3	T/R	E(3)A1-092 R(3)A1-092	AT-92/AR-92
[611]	Repeater 4 AC trouble/Rest.	AC power loss detected/restored for Repeater 4	T/R	E(3)A1-093 R(3)A1-093	AT-93/AR-93
*	A/R = alarms/restores; T/R = tampers/restorers; O/C = openings/closings; MA/R = miscellaneous alarms/restores; T = test transmissions				
**	UU = user number (user01-16,40); ZZ = zone number (01-34).				
***	Use the "Fail to close" event code [(4)54] to report closing or activity delinquency. Ensure the central station is aware that this code is used.				
****	Zones and panic pendants are identified, wireless keys can be identified for openings and closings.				

**Contact ID Zone Alarm/Restore Event Codes**

(as per SIA DCS: 'Contact ID' 01-1999):

Program any of these codes for zone alarms/restores when using the standard (non-automatic) Contact ID reporting format.

Zone Definition	SIA Auto Rep Codes	Contact ID Auto Rep Codes	<b>SIA Format Automatic Zone Alarm/Restore Codes</b>	
Delay 1	BA-ZZ/BH-ZZ	(1) 3A	<b>Medical Alarms</b>	(1)34 Entry / Exit
Delay 2	BA-ZZ/BH-ZZ	(1) 3A	(1)AA Medical	(1)35 Day / Night
Instant	BA-ZZ/BH-ZZ	(1) 3A	(1)A1 Pendant Transmitter	(1)36 Outdoor
Interior	BA-ZZ/BH-ZZ	(1) 3A	(1)A2 Fail to Report In	(1)37 Tamper
Interior Stay/Away	BA-ZZ/BH-ZZ	(1) 3A	<b>Fire Alarms</b>	(1)38 Near Alarm
Delay Stay/Away	BA-ZZ/BH-ZZ	(1) 3A	(1)1A Fire Alarm	<b>General Alarms</b>
24-Hr. Supervisory	US-ZZ/UR-ZZ	(1) 5A	(1)11 Smoke	(1)4A General Alarm
24-Hr. Supervisory Buzzer	UA-ZZ/UH-ZZ	(1) 5A	(1)12 Combustion	(1)43 Exp. Module Failure
24-Hr. Burg	BA-ZZ/BH-ZZ	(1) 3A	(1)13 Water Flow	(1)44 Sensor Tamper
24-Hr. Gas	GA-ZZ/GH-ZZ	(1) 51	(1)14 Heat	(1)45 Module Tamper
24-Hr. Heat	FA-ZZ/FH-ZZ	(1) 58	(1)15 Pull Station	(1)4A Cross Zone Police Code
24-Hr. Medical	MA-ZZ/MH-ZZ	(1) AA	(1)16 Duct	<b>24 Hour Non-Burglary</b>
24-Hr. Panic	PA-ZZ/PH-ZZ	(1) 2A	(1)17 Flame	(1)5A 24 Hour non-Burg
24-Hr. Emergency	QA-ZZ/QH-ZZ	(1) A1	(1)18 Near Alarm	(1)51 Gas Detected
24-Hr. Water	WA-ZZ/WH-ZZ	(1) 54	<b>Panic Alarms</b>	(1)52 Refrigeration
24-Hr. Freeze	ZA-ZZ/ZH-ZZ	(1) 59	(1)2A Panic	(1)53 Loss of Heat
Interior Delay	BA-ZZ/BH-ZZ	(1) 3A	(1)21 Duress	(1)54 Water Leakage
Instant Stay/Away	BA-ZZ/BH-ZZ	(1) 3A	(1)22 Silent	(1)55 Foil Break
24-Hr. Non-latching Tamper	TA-ZZ/TR-ZZ	(3) 83	<b>Burglar Alarms</b>	(1)57 Low Bottled Gas Level
Day Zone	BA-ZZ/BH-ZZ	(1) 3A	(1)3A Burglary	(1)58 High Temp
Night Zone	BA-ZZ/BH-ZZ	(3) 83	(1)31 Perimeter	(1)59 Low Temp
Delayed 24-Hr. Fire (Wireless)	FA-ZZ/FH-ZZ	(1) 1A	(1)32 Interior	(1)61 Loss of Air Flow
Standard 24-Hr. Fire (Wireless)	FA-ZZ/FH-ZZ	(1) 1A	(1)33 24 Hour	(1)34 Entry / Exit
24-Hr. Auto Verified Fire (Wireless)	FA-ZZ/FH-ZZ	(1) 1A		
24-Hr. CO Alarm	GA-ZZ/GH-ZZ	(1) 62		
ZZ = zones 01-34				

## Appendix B: 2-Way Audio Verification (SCW9057 only)

The following information is intended for use by the Central Station Operator.

- The SCW9057 Audio Verification provides Talk and Listen-in capability for audio verification of alarms. This allows the central station to communicate with the occupants through the microphone and speaker of the alarm system.
- After one or more alarms have been sent to the central station, the system holds the line for 90 seconds. During this period, the siren continues to sound, indicating that a 2-way voice session is available and may be initiated. If any key is pressed by the user during this time, a 90-second 2-way voice session begins in low gain listen-in only mode. The siren is silenced for the duration of the 2-way voice session and all microphones are turned on. When the 2-way session terminates, the siren turns back on unless it has timed out.
- The commands indicated below are a subset of the SIA Audio Verification Standard (November 11, 1997).

### The 2-way Audio Session

1. **Zone Violation:** A 2-way audio session begins with the violation of a zone that has zone attribute 9 enabled.

By default, the following do NOT initiate a 2-way session:

- Supervisory, zone 9
- Keyswitch zones, zone 22 and 23
- 24-Hour Non-Alarm (local), zone 26
- 24-Hour Non-Latching Tamper, zone 36
- 24-Hour Carbon Monoxide (wireless), zone 81
- Fire Zones, zone 87, 88, 89 and the Fire Key

For more information, see section [101]-[134], attribute 9 in Chapter 5.

By default 1-way audio (Listen-in only) is initiated by the following:

- Silent Panic events (Silent [P], Silent Panic zone)
- Duress alarm

2. **Communication to the Monitoring Station:** One of the reporting codes/actions listed below is sent to the monitoring station when the appropriate alarm is triggered.

Format	Reporting Code/Event
SIA	L90
Contact ID	606
BPS	Communicates the Event, then automatically enters into 2-way Audio mode.

3. **Alerting the Operator:** When the reporting code is received by the monitoring station or a 2-way session is automatically initiated, a 2-way Initiation (Start) tone will be sounded to alert the operator. A high (1800 Hz) tone and a low (900 Hz) tone are used to generate the tones listed below. Short tone duration is 100ms. Long tone duration is 1 second.

2-way Initiation (Start) Tone:	
3 Hi Tones (Short)	After the third short Hi tone has sounded, the panel switches directly into 'Listen-in" mode without a keypress from the monitoring station.
Reminder Tones:	
1 Hi Tone (Short)	1 Short hi tone indicates 20 seconds are left in the audio session.
1 low Tone	1 Short low tone indicates 10 seconds are left in the audio session.
Subsequent Alarm:	
1 Hi Tone Long	1 long hi tone indicates a new alarm event if Section [023] Option 6 (New Alarms will not disconnect 2-way Audio) is enabled, alarms are delayed. If disabled the audio session will terminate. NOTE: Receiving a subsequent alarm event tone will not restart the 90 second session timer.
Subsequent Fire Event:	
Hi, Low, Hi (Short)	3 short (100ms) tones Hi, Low, Hi indicates a new Fire alarm if Section [023] Option 6 (New Alarms will not disconnect 2-way Audio) is enabled. If disabled the audio session will terminate. NOTE: Receiving a subsequent alarm event tone will not restart the 90 second session timer.

4. **Initiating, Control and Termination of the Session:** The Operator controls the session the using the Audio Control Telephone Key Functions listed in the table below. To select the commands, press [\*][0] followed by the key number(s) indicated below:

Key	Function	Description
1/4	Talk to Speaker	Connects the monitoring station to the speaker.
2	VOX Mode	Connects the monitoring station to the system in VOX Mode (see VOX Support below).
3/6	Listen to Microphone	Connects the monitoring station to the microphone.
4	Lo-Gain Talk to Speaker	Connects the monitoring station to the speaker at the low volume output level.
6	Lo-Gain Listen to Microphone	Connects the monitoring station to the microphone at the low gain input level.
7	Extend Time	Restarts the session timer (90 seconds) to prevent timeout. To extend the time and take no other action use this function. Pressing any key automatically extends the time.
99	Disconnect	Disconnects the session. The second "9" must be pressed within 1 second of pressing the first "9." Use the "Disconnect" key sequence before hanging up during a Talk / Listen-In session.

**VOX Support:** When in VOX mode the alarm panel automatically switch between the phone line and internal microphone/speaker being active depending on which one is loudest. Push to Talk overrides VOX – this is performed by switching into a talk mode at the monitoring station.

**Hang-up Auto-detection:** The alarm panel automatically disconnects if the central station receiver disconnects before the operator picks up the line. The panel will consider five seconds of continuous dial tone, or busy tone to be a disconnect condition. If the operator does NOT terminate the call using the disconnect command (99), the alarm panel will consider five seconds of continuous dial tone, or busy tone to be a disconnect condition.

**Bell/Buzzer Silent During 2-Way Audio:** When the panel has an audible alarm, the bell can be programmed to remain active until the 2-Way Audio session starts and then the bell will be silent (Section [600], option 7 off) to allow the user to hear the operator. All buzzer activity, except keypresses, will be silent when 2-way audio is active. If the panel has not been disarmed at the termination of the 2-Way Audio session, the bell will restart for the timeout duration. Door chime is disabled during a 2-way Audio session. Any activity that normally sounds door chime will occur and the door chime will not sound.

## Appendix C: Communicator Format Options

The following format options are programmable in section [350] on page 27

### 01 20 BPS, 1400 Hz handshake 02 20 BPS, 2300 Hz handshake

- BPS Formats - 0 is not valid in Account or Rep Code (A must be used).

Depending on the pulse format, the panel communicates using the following: 3/1, 3/2, 4/1 or 4/2, 1400 or 2300 Hz handshake, 20 bits per second, non-extended.

Digit "0" sends no pulses and is used as a filler. When programming account numbers enter four digits. When programming a three digit account number the fourth digit must be programmed as a "0" which will act as a filler digit. If an account number has a "0" in it, substitute a HEX digit "A" for the "0."

Examples:

- 3 digit account number [123] - program [1230]
- 3 digit account number [502] - program [5A20]
- 4 digit account number [4079] - program [4A79]

Two digits must be entered when programming reporting codes. If one digit reporting codes are used, the second digit must be programmed as "0". If "0" is to be transmitted, substitute a HEX digit "A" for the "0".

Examples:

- 1 digit reporting code [3] - program [30]
- 2 digit reporting code [30] - program [3A]

To prevent the panel from reporting an event, program the reporting code for the event as [00] or [FF].

### 03 DTMF Contact ID

- **ADEMCO Contact ID - 0 is not valid in Account or Rep Code (A must be used, 10 in checksum)**

Contact ID is a specialized format that communicates information quickly using tones rather than pulses. The format also allows more information to be sent. For example, rather than reporting an alarm zone 1, the Contact ID format can also report the type of alarm, such as Entry/Exit alarm zone 1.

If **Contact ID Sends Automatic Reporting Codes** is selected, the panel automatically generates a reporting code for each event. These identifiers are listed in Appendix A. If the Automatic Contact ID option is not selected, reporting codes must be programmed. The 2-digit entry determines the type of alarm. The panel automatically generates all other information, including the zone number.

NOTE: If Automatic Contact ID is selected, the panel automatically generates all zone and access code numbers, eliminating the need to program these items.

NOTE: The zone number for Zone Low Battery and Zone Fault events will not be identified when Pulse formats are used.

If the **Contact ID uses Automatic Reporting Codes** option is enabled, the panel will operate as follows:

- If an event's reporting code is programmed as [00], the panel will not attempt to call the central station.
- If the reporting code for an event is programmed as anything from [01] to [FF], the panel automatically generates the zone or access code number. See Appendix A for a list of transmitted codes.

If the **Contact ID uses Programmed Reporting Codes** option is enabled, the panel will operate as follows:

- If an event's reporting code is programmed as [00] or [FF], the panel will not attempt to call central station.
- If the reporting code for an event is programmed as anything from [01] to [FE], the panel will send the programmed reporting code.

Account numbers must be four digits:

- If the digit "0" is in the account number substitute the HEX digit "A" for the "0."
- All reporting codes must be two digits.
- If the digit "0" is in the reporting code substitute the HEX digit "A" for the "0."
- To prevent the panel from reporting an event, program the reporting code for the event as [00] or [FF].

See: Contact ID Sends Automatic Reporting Codes section [381], Option [7]

### 04 SIA FSK

- **SIA -0 is valid in Account or Rep Code (not 00 in a Reporting code)**
- **SIA -0 uses 300 Baud FSK as the communication media. Account Code can be 4 or 6 hexadecimal digits. Reporting codes must be 2 digits. The SIA format transmits a 4 (or 6) digit account code, 2 digit identifier code and 2 digit reporting code. The 2 digit identifier is pre programmed by the panel.**

SIA is a specialized format that communicates information quickly using frequency shift keying (FSK) rather than pulses. The SIA format automatically generates the type of signal being transmitted, such as Burglary, Fire, Panic etc. The two digit reporting code is used to identify the zone or access code number.

If the SIA format is selected the panel can be programmed to automatically generate all zone and access code numbers eliminating the need to program these items.

If the **SIA Sends Automatic Reporting Codes** option is enabled the panel will operate as follows:

1. If the reporting code for an event is programmed as [00] the panel will not attempt to call the central station.
2. If the reporting code for an event is programmed as anything from [01] to [FF] the panel will AUTOMATICALLY generate the zone or access code number.
3. During a partial closing, all bypassed zones are reported.

**Communicator Call Direction Options** can be used to disable reporting of events such as Openings/Closings. Also, if all the Opening/Closing reporting codes were programmed as [00] the panel would not report.

If the **SIA Sends Automatic Reporting Codes** option is disabled the panel operates as follows:

1. If the reporting code for an event is programmed as [00] or [FF] the panel will not attempt to call the central station.
2. If the reporting code for an event is programmed as anything from [01] to [FE] the panel will send the programmed reporting code.
3. During a partial closing, bypassed zones are not reported.

NOTE: The zone number for Zone Low Battery and Zone Fault events will not be identified when Programmed SIA is used.

See: **SIA Sends Automatic Reporting Codes - Section [381], Option [3],**

**Communicator Call Direction Options - Section [351] to [376],**

**SIA Identifiers - Appendix A**

### 06 Residential Dial

If Residential Dial is programmed and an event that is programmed to communicate occurs, the panel will seize the line and dial the appropriate telephone number(s). Once the dialing is complete, the panel will emit an ID tone and wait for a handshake (press a 1, 2, 4, 5, 7, 8, 0, \* or # key from any telephone). It will wait for this handshake for the duration of **Post Dial Wait for Handshake** timer. Once the panel receives the handshake, it will emit an alarm tone over the telephone line for 20 seconds. If several alarms occur at the same time, only one call will be made to each telephone number the panel is programmed to call.

# Appendix D: Regulatory Approvals Information

## North America

### FCC COMPLIANCE STATEMENT

#### CAUTION: Changes or modifications not expressly approved by Digital Security Controls could void your authority to use this equipment.

This equipment has been tested and found to comply with the limits for a Class B digital device, pursuant to Part 15 of the FCC Rules. These limits are designed to provide reasonable protection against harmful interference in a residential installation. This equipment generates, uses and can radiate radio frequency energy and, if not installed and used in accordance with the instructions, may cause harmful interference to radio communications. However, there is no guarantee that interference will not occur in a particular installation. If this equipment does cause harmful interference to radio or television reception, which can be determined by turning the equipment off and on, the user is encouraged to try to correct the interference by one or more of the following measures:

- Re-orient the receiving antenna.
- Increase the separation between the equipment and receiver.
- Connect the equipment into an outlet on a circuit different from that to which the receiver is connected.
- Consult the dealer or an experienced radio/television technician for help.

The user may find the following booklet prepared by the FCC useful: "How to Identify and Resolve Radio/Television Interference Problems". This booklet is available from the U.S. Government Printing Office, Washington D.C. 20402, Stock # 004-000-00345-4.

### IMPORTANT INFORMATION

This equipment complies with Part 68 of the FCC Rules and, if the product was approved July 23, 2001 or later, the requirements adopted by the ACTA. On the side of this equipment is a label that contains, among other information, a product identifier. If requested, this number must be provided to the Telephone Company.

**Product Identifier** US:F53AL01B9057 USOC Jack:RJ-31X

### Telephone Connection Requirements

A plug and jack used to connect this equipment to the premises wiring and telephone network must comply with the applicable FCC Part 68 rules and requirements adopted by the ACTA. A compliant telephone cord and modular plug is provided with this product. It is designed to be connected to a compatible modular jack that is also compliant. See installation instructions for details.

### Ringer Equivalence Number (REN)

The REN is used to determine the number of devices that may be connected to a telephone line. Excessive RENs on a telephone line may result in the devices not ringing in response to an incoming call. In most but not all areas, the sum of RENs should not exceed five (5.0). To be certain of the number of devices that may be connected to a line, as determined by the total RENs, contact the local Telephone Company. For products approved after July 23, 2001, the REN for this product is part of the product identifier that has the format US: AAAEQ##TXXXX. The digits represented by ## are the REN without a decimal point (e.g., 03 is a REN of 0.3). For earlier products, the REN is separately shown on the label.

REN = 0.1B

### Incidence of Harm

If this equipment (SCW9055/57(D)(G)(I)(-SM)-433) causes harm to the telephone network, the telephone company will notify you in advance that temporary discontinuance of service may be required. But if advance notice is not practical, the telephone company will notify the customer as soon as possible. Also, you will be advised of your right to file a complaint with the FCC if you believe it is necessary.

### Changes in Telephone Company Equipment or Facilities

The Telephone Company may make changes in its facilities, equipment, operations or procedures that could affect the operation of the equipment. If this happens the Telephone Company

will provide advance notice in order for you to make necessary modifications to maintain uninterrupted service.

### Equipment Maintenance Facility

If trouble is experienced with this equipment (SCW9055) for repair or warranty information, contact the facility indicated below. If the equipment is causing harm to the telephone network, the Telephone Company may request that you disconnect the equipment until the problem is solved. This equipment is of a type that is not intended to be repaired by the end user.

**DSC c/o APL Logistics 757 Douglas Hill Rd., Lithia Springs, GA 30122**

### Additional Information

Connection to party line service is subject to state tariffs. Contact the state public utility commission, public service commission or corporation commission for information.

Alarm dialing equipment must be able to seize the telephone line and place a call in an emergency situation. It must be able to do this even if other equipment (telephone, answering system, computer modem, etc.) already has the telephone line in use. To do so, alarm dialing equipment must be connected to a properly installed RJ-31X jack that is electrically in series with and ahead of all other equipment attached to the same telephone line. Proper installation is depicted in the figure below. If you have any questions concerning these instructions, you should consult your telephone company or a qualified installer about installing the RJ-31X jack and alarm dialing equipment for you.

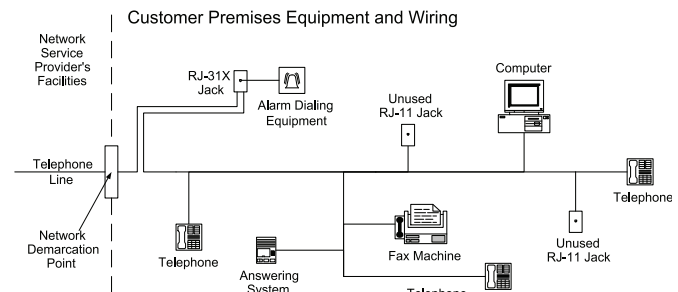

### INDUSTRY CANADA STATEMENT

**NOTICE:** This product meets the applicable Industry Canada technical specifications. Le présent matériel est conforme aux spécifications techniques applicables d'Industrie Canada.

The Ringer Equivalence Number (REN) for this terminal equipment is 0.1. L'indice d'équivalence de la sonnerie (IES) du présent matériel est de 0.1.

The Ringer Equivalence Number is an indication of the maximum number of devices allowed to be connected to a telephone interface. The termination on an interface may consist of any combination of devices subject only to the requirement that the sum of the RENs of all the devices does not exceed five.

L'indice d'équivalence de la sonnerie (IES) sert à indiquer le nombre maximal de terminaux qui peuvent être raccordés à une interface téléphonique. La terminaison d'une interface peut consister en une combinaison quelconque de dispositifs, à la seule condition que la somme d'indices d'équivalence de la sonnerie de tous les dispositifs n'excède pas 5.

The term "IC:" before the radio certification number only signifies that Industry Canada technical specifications were met.

Certification Number:

IC: IC:160A-9057 (Models SCW9055/57-433)

IC:160A-9057G (Models SCW9055/57(D)(G)(I)(-SM)-433)

This Class B digital apparatus complies with Canadian ICES-003.

Cet appareil numérique de la classe B est conforme à la norme NMB-003 du Canada.

This device complies with Industry Canada licence-exempt RSS standard(s). Operation is subject to the following two conditions: (1) this device may not cause interference, and (2) this device must accept any interference, including interference that may cause undesired operation of the device.

Cet appareil est conforme avec Industrie Canada exempts de licence standard RSS (s). Le fonctionnement est soumis aux deux conditions suivantes: (1) cet appareil ne peut pas provoquer d'interférences et (2) cet appareil doit accepter toute interférence, y compris les interférences qui peuvent causer un mauvais fonctionnement de l'appareil.

## This product has been tested and found in compliance with the following standards:

UL1023 Household Burglar-Alarm System Units

UL985 Household Fire Warning System Units

UL1635 Digital Alarm Communicator System Units

ULC-S545-02 Residential Fire Warning System Control Units

ORD-C1023-1974 Household Burglar-Alarm System Units

This product has also been tested and found in compliance with the ANSI/SIA CP-01-2010 Control Panel Standard – Features for False Alarm Reduction.

This product is UL/ULC listed under the following categories:

UTOU/UTOUC Control Units and Accessories, Household System Type

NBSX/NBSXC Household Burglar Alarm System Units

AMTB Control Panels, SIA False Alarm Reduction

The product is labeled with the UL and ULC listing marks along with the SIA CP-01 compliance statement (Also Classified in accordance with SIA-CP-01 Standard) as proof of compliance with the above mentioned standards. For further information on this product's listings please also refer to the official listing guides published at the UL web site ([www.ul.com](http://www.ul.com)) under Certifications Section.

UL/ULC Residential Fire and Burglary Installations:

For ULC Installations refer to the Standard for the Installation of Residential Fire Warning Systems, CAN/ULC-S540.

- All burglary-type zones shall be configured with SEOL or DEOL configuration (refer to section [133] and [134], bit 15 or 16 shall be ON)
- Use at least one WS4916 Smoke Detector for Fire Installations (refer to section [001], fire zone shall be programmed as type 89)
- The entry delay shall not exceed 60 seconds (refer to section [005])
- The exit delay shall not exceed 120 seconds (refer to section [005])
- The minimum Bell Time-out is 4 minutes (refer to section [005])

### Note: For ULC Residential Fire Installations the minimum Bell Time-out is 5 minutes

- Temporal Three Fire Signal shall be enabled (refer to section [013], option 8 shall be ON)
- Arm/Disarm Bell Squawk shall be enabled when using wireless key WS4939 (refer to section [014], option 1 shall be ON)
- Auxiliary Power boost shall be enabled (refer to section [014], option 4 shall be ON)
- A code shall be required for bypassing (refer to section [015], option 5 shall be ON)
- Trouble beeps shall be enabled (refer to section [023], option 7 shall be ON)
- AC trouble indication LED shall be enabled (refer to Keypad Programming, section [075], options 5 and 6 shall be ON)
- DACT Communicator shall be enabled for Supervising Station Monitoring (refer to section [380], option 1 shall be ON).

### Note: The DACT communicator for this product has no line security.

- Telephone Line Monitoring (TLM) shall be enabled (refer to section [015], option 7 shall be ON)

### Note: This product is programmed to perform 5 attempts for communication of an event to the supervising station. If unsuccessful, a Fail To Communicate (FTC) trouble is generated.

- Test transmission cycle shall be set for monthly transmission (refer to section [377])

### Note: For ULC Residential installations set for daily test transmission

- Wireless Supervision window shall be enabled (refer to Wireless Programming, sections [804] [82] to [85])
- Wireless Supervision window shall be set to 4h for Fire Installations (refer to Wireless Programming, section [804][81] shall be programmed with the value [16])
- Wireless Supervision window shall be set to 24h for Burglary Installations only (refer to Wireless Programming, section [804][81] shall be programmed with the value [96])
- RF Jam detection shall be enabled (refer to Wireless Programming, section [804] [900], option 7 shall be OFF)
- Bells will be active During 2-way Audio (refer to section [600], opt 7 shall be ON)
- New Alarms will Disconnect 2-way Audio (refer to section [023], opt 6 shall be OFF)
- When the 2- way audio feature is enabled (section [601] option 1-3 is ON) ensure that section [023] option 6 is OFF and section [600] option 7 is ON

## Programming

The notes in the programming sections describing the system configurations for UL/ULC listed installations shall be implemented.

### Bell Location

The alarm sounding device (bell) shall be located where it can be heard by the person operating the security system during the daily arming and disarming cycle.

### Casual Users

The installer should caution the user(s) not to give system information (e.g. codes, bypass methods, etc.) to casual users (baby-sitters or service people). Only the One-Time Use codes shall be given to casual users.

### User Information

The installer should advise the users and note in the User's Manual:

- Service organization name and telephone number
- The programmed exit time
- The programmed entry time
- Test system weekly

## SIA False Alarm Reduction Installations

For a list of the defaults value programmed when the unit is shipped from the factory and for any other programming information refer to Appendix D: False Alarm Reduction. **Caution**

Call Waiting Cancel (Section [382], Option 4) feature on a non-Call Waiting line will prevent successful communication to the supervising station. Fire Alarm Verification feature (Auto Verified Fire Zone type [89]) is supported on the DSC Wireless Smoke Detector, Model WS4916. The fire alarm delay is 40s.

### Notes

Programming at installation may be subordinate to other UL requirements for the intended application.

Cross zones have the ability to individually protect the intended area (e.g. motion detectors which overlap).

Cross zoning is not recommended for line security Installations nor is to be implemented on exit/entry zones.

There is a communication delay of 30 seconds in this control panel. It can be removed, or it can be increased up to 45 seconds at the option of the end user by consulting with the installer.

Do not duplicate any reporting codes. This applies for all communication formats other than SIA or CID sending automatic programmed reporting codes.

The security system shall be installed with the sounding device activated and the communicator enabled for transmission using SIA or CID format.

SIA Feature Programming Section	Comments	Range/Default	Requirement
<b>Exit Time</b> [005], 3rd entry	Access to Entry and Exit delays and Bell Time Out for the system	Range:45- 255 seconds <b>Default:</b> 60 sec.	Required (programmable)
<b>Progress Annunciation/Disable - for Silent Exit</b> [014], Option 6 ON	Enables audible exit beeps from the keypad for the duration of exit delay	Keypads may be disabled <b>Default:</b> Enabled	Allowed
<b>Exit Time Restart</b> [014], Option 2 ON	Enables the exit delay restart feature	<b>Default:</b> Enabled	Required
<b>Auto Stay Arm on Un-vacated Premises</b> [001]-[002] Zone type 05, 06	Function Key: Stay Arming. All Stay/Away type zones (05, 06) will be automatically bypassed	If no exit after full arm <b>Default:</b> Enabled	Required
<b>Exit Time and Progress Annunciation/Disable or Remote Arming</b> [005] and [014] bit 6	System Times and Audible Exit beeps can be disabled when using the Key fob to arm away the system	<b>Default:</b> Enabled	Allowed
<b>Entry delay(s)</b> [005], 1st and 2nd entry	Access to Entry and Exit delays and Bell Time Out for the system Note: Combined Entry delay and Communications Delay (Abort Window) shall not exceed 60s	Range: 30 sec. to 4 min. <b>Default:</b> 30 sees	Required (programmable)
<b>Abort Window</b> for Non-Fire zones [101]-[134] bit 6 ON	Access to zone attributes, i.e, swinger shutdown, transmission delay and cross zone. Individual zones attribute bit 6 (Transmission delay) is by default ON	May be disabled by zone or zone type <b>Default:</b> Enabled	Required
<b>Abort Window - for Non-Fire zones</b> [377], 4th entry	Access to the programmable delay before communicating alarms Note: Combined Entry delay and Communications Delay (Abort Window) shall not exceed 60s	Range: 20 - 45 sec. <b>Default:</b> 30 sees	Required (programmable)
<b>Abort Annunciation</b> [382], Option 3 ON	Enables the "Communication Cancelled" message display on keypad	Annunciate that no alarm was transmitted <b>Default:</b> Enabled	Required
<b>Cancel Annunciation</b> [328], 8th entry	Access to the reporting code for Alarm Cancelled	Annunciate that a Cancel was transmitted <b>Default:</b> Enabled	Required
<b>Duress Feature</b> [*][5] Master Code Option 2 ON	Do not derive code from an existing Master/User code (e.g., Master code is 1234, the duress code should not be 1233 or 1235)	No 1+/- derivative of another user code. No duplicates with other user codes <b>Default:</b> disabled	Allowed
<b>Cross Zoning</b> [016] Option 1 [101]-[134] bit 8 OFF	This option enables Cross Zoning for entire system. Individual zones can be enabled for Cross zoning via Zone attribute bit 8 in sections [101] - [134]	Programming required <b>Default:</b> Disabled	Required
<b>Cross Zone Timer</b> [176]	Access to the programmable Cross Zone timer	May program Range: 001-255 sec./min. <b>Default:</b> 60 seconds	Allowed
<b>Swinger Shutdown for Alarms</b> [377] 1st entry	Access to the swinger shutdown limit for zone alarms.	For all non-fire zones shut down at 1 or 2 trips <b>Default:</b> 2 trips	Required (programmable)
<b>Swinger Shutdown Enable</b> [101] - [134] bit 6 ON	Access to zone attributes, i.e., swinger shutdown, transmission delay and cross zone. Individual zones attribute bit 6 (Swinger shutdown enabled) is by default ON	For non-police response zones <b>Default:</b> Enabled	Allowed
<b>24-Hr. Auto_verified Fire</b> (Wireless) Zone type [89]	Access to 24-Hr. Auto_verified Fire (Wireless)	Activates If a restore is Not received within the specified time <b>Default:</b> disabled	Required
<b>Call Waiting Cancel Dial String</b> [304], [382], Option 4 OFF	Access to the dialing sequence used to disable call waiting	Dependant on user phone line <b>Default:</b> disabled	Required

<b>System Test:</b> [*][6] Master Code, Option 4	The system activates all keypad sounders, bells or sirens for 2 seconds and all keypad lights turn on. Refer to the <i>User Manual (part no. 29007827)</i> .
<b>Walk Test Mode:</b> [*][6] Opt 8	This mode is used to test each zone on the system for proper functionality.
<b>Alarm Communications During Walk Test</b> [382] Option 2:	Enables Communication of zone alarms while Walk Test is active.
<b>Walk Test End and Begin Reporting Codes</b> [348], 1 <sup>st</sup> and 2 <sup>nd</sup> Entries	Access to the reporting codes for Walk Test Begin and Walk Test End.

© 2013 Tyco International Ltd. and its Respective Companies. All Rights Reserved.

The trademarks, logos, and service marks displayed on this document are registered in the United States [or other countries]. Any misuse of the trademarks is strictly prohibited and Tyco International Ltd. will aggressively enforce its intellectual property rights to the fullest extent of the law, including pursuit of criminal prosecution wherever necessary. All trademarks not owned by Tyco International Ltd. are the property of their respective owners, and are used with permission or allowed under applicable laws.

Product offerings and specifications are subject to change without notice. Actual products may vary from photos. Not all products include all features. Availability varies by region; contact your sales representative.



Technical Support: 1-800-387-3630 (Can/US)  
905-760-3000 (Intl.) [www.dsc.com](http://www.dsc.com)  
Printed in Canada

